

Series V7-W Terminals

A comprehensive selection of rugged connections



Sprecher + Schuh's V7-W terminals are designed to meet the three most important criteria when selecting a terminal block line – ease of wiring, secure connections, and durability. The line is also comprehensive, offering a wide array of terminal types for most circuits and functions, from control to low level power.

The size you need

V7-W feed-through terminals come in ten sizes and are rated to 600VAC (800V-IEC). They accommodate a full range of wire sizes from 30AWG to 3/0 AWG (0.5mm² to 70mm² wire cross section). Many “specialty” feed-through terminals are also available that provide multiple terminations or increase the density of connections. This reduces panel space and saves money.

Comprehensive selection of special terminals

Aside from the broad selection of standard feed-through terminals, many special terminals are also part of the V7-W line, including:

- Two level terminals
- High Current terminals
- Ground terminals
- Dual connection terminals
- Diode terminals
- Plug-in style terminals
- Various isolating terminals
- Fuse terminals
- Sensor terminals
- Thermocouple terminals
- Proximity switch terminals

Even the most varied circuit requirements can be supported by the broad selection offered with this line.

Super reliable connections

The most important aspect of a terminal block is to join wires in a reliable connection. With V7-W terminals, a cone shaped guide allows easy insertion of the wire into a nickel plated barrel. As tightening torque is applied to

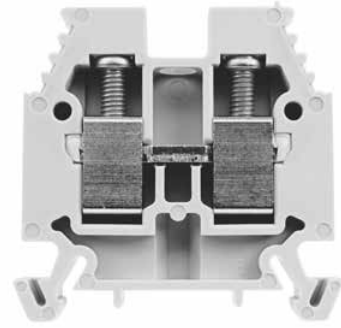

Stainless steel screws and nickel plated current bars provide a strong, corrosion resistant connection

strong stainless steel screws, the wire is secured between a recessed contact pad and serrated current bar. This corrosion-resistant clamping mechanism provides excellent performance in the most demanding industrial conditions.



Superior insulation and protection features

All metal parts are recessed, providing a touch-safe, dead front design for optimum safety. Terminal bodies are manufactured from Polyamide 6.6, known for its excellent thermal stability, impact resistance and resistance to electrical creepage. The insulating cases are rated up to 90°C (195°) for continuous operation. They also stay elastic down to -40°C (-40°F) without fracturing.









International approvals

Sprecher + Schuh's V7-W terminal block line is UL recognized and CSA Certified. Many terminals have also been certified for use in hazardous locations. The line also carries the CE Mark for use in most international markets.









V7 Terminals

Quick Selection Guide (refer to page indicated for complete information and detailed pricing)

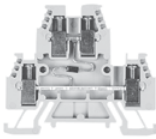
| Terminal | Description | Type | Overall Term. Width | Cross-sec. [mm ²] | Catalog Number | See Page... |
|---|--|--------------------------------------|--|-------------------------------|------------------|-----------------|
| Through Terminals | | | | | | |
|  | Standard Feed-Through Blocks Provides one straight-through circuit for wire sizes up to 70 mm ² . | Color: gray (other colors available) | 5 | 2.5 | V7-W3 | N5 |
| | | | 6 | 4 | V7-W4 | N5 |
| | | | 7 | 6 | V7-W6 | N5 |
| | | | 8 | 10 | V7-W10 | N6 |
| | | | 11 | 16 | V7-W16S | N6 |
| | | | 14 | 35 | V7-W35 | N7 |
| | | | 23 | 70 | V7-W70 | N7 |
|    | Specialty Feed-Through Blocks Provides one straight-through circuit with 3 wire terminals. | Color: gray (other colors available) | 5 | 2.5 | V7-W3TW | N9 |
| | Return Terminals Single circuit terminal block with terminals on common side. | Color: gray | 5 | 2.5 | V7-WR3 | N9 |
| | Two Level Terminals | Color: gray | 5 | 2.5 | V7-WD3 | N8 |
| | | | 6 | 4 | V7-WD4 | N8 |
| | | | 7 | 6 | V7-WD6 | N8 |
| Ground Terminals | | | | | | |
|  | Grounding Terminals | Color: green / yellow | 6 | 4 | V7-WG4 | N10 |
| | | | 7 | 6 | V7-WG6 | N10 |
| | | | 8 | 10 | V7-WG10S | N10 |
| | | | 13 | 16 | V7-WG16 | N11 |
| | | | 18 | 35 | V7-WG35 | N11 |
| | | | 22 | 70 | V7-WG70 | N11 |
| | | | 6 | 2.5 | V7-WDG4C | N12 |
| Isolation and Plug-in Style Blocks | | | | | | |
|  | Knife Style Isolation Blocks Used to isolate a circuit after power has been removed by an appropriate disconnect switch. | Color: gray | 5 | 2.5 | V7-WKD3 | N16 |
| | | | 5 | 2.5 | V7-WKD3TP | N16 |
| | | | 9 | 6 | V7-WKD6 | N16 |
|  | Handle Style Isolation Block Used to isolate a circuit after power has been removed by an appropriate disconnect switch. | Color: black | 9 | 4 | V7-H7 | N17 |
|  | Plug-in Style Block Accepts plugs listed on opposite page. | without insert | 6 | 2.5 | V7-W4P | N20 |
| | | | without insert, with test plug screws | 6 | 2.5 | V7-W4PTP |
|  | Two & Three Level Plug-in Style Terminal Blocks - Accepts plugs listed on opposite page. | two level, without insert | 6 | 2.5 | V7-WD4P | N21 |
| | | | three level, without insert, with ground | 6 | 2.5 | V7-WDG4P |

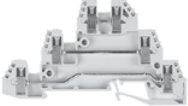
Quick Selection Guide (refer to page indicated for complete information and detailed pricing)

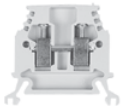
| Terminal | Description | Type | Overall Term. Width | Cross-sec. [mm ²] | Catalog Number | See Page... |
|---|---|--|--------------------------------------|--------------------------------------|--|--|
| Isolation and Plug-in Style Blocks (continued) | | | | | | |
| Inserts for V7-W4P— Order Separately | | | | | | |
|  | Disconnect Plug | | | | V7-DP4 | N28 |
|  | Component Plug | | | | V7-CP4 | N28 |
|  | Fuse Plug | 5 x 20 mm; without indication 5 x 20 mm; with LED 5 x 20 mm; with LED | | | V7-FP4 V7-FP424 V7-FP4250 | N28 |
| Two Level Component Terminals | | | | | | |
|  | Diode Terminals | with a fixed connection with a diode in forward bias with a diode in reverse bias | 6 6 6 | 4 4 4 | V7-WD4C V7-WD4DF V7-WD4DR | N22 |
| Fusible Terminals | | | | | | |
|  | Fuse Terminals (fuses not supplied) | 5 x 20 mm, without indication 5 x 20 mm, without indication 5 x 20 mm, with LED 5 x 20 mm, with neon lamp 6.3 x 32 mm, without indication 6.3 x 32 mm, without indication 6.3 x 32 mm, with LED 6.3 x 32 mm, with neon lamp | 8 8 8 8 9 9 9 9 | 4 4 4 4 4 4 4 4 | V7-WFB4 V7-WFB10V V7-WFB424 V7-WFB4250 V7-H6 V7-WFB10VA V7-H5 V7-H4 | N13 N15 N13 N13 N14 N15 N14 N14 |
| Sensor Terminals | | | | | | |
|  | Sensor Supply Terminal (Initiator) | without LED with LED PNP with LED NPN | 5 5 5 | 2.5 2.5 2.5 | V7-WTF3 V7-WTF3LP V7-WTF3LN | N18 N18 N18 |
|  | Sensor Terminal (Initiator) | no indicator with LED PNP with LED NPN | 5 5 5 | 2.5 2.5 2.5 | V7-WTS3 V7-WTS3LP V7-WTS3LN | N19 N19 N19 |
| Thermocouple Terminals | | | | | | |
|  | Thermocouple Terminals | Chromel / Constantan Iron / Constantan Copper / Constantan | 10 10 10 | 2.5 2.5 2.5 | V7-WTC3E V7-WTC3J V7-WTC3T | N23 N23 N23 |

Standard Feed-Through Blocks ①

| Ordering and Technical Information ① | 2.5mm ² | | | 4mm ² | | | 6mm ² | | | | | | | | |
|---|----------------------------------|---------------------------------|---------------------------------|----------------------------------|---------------------------------|-------------------------|----------------------------------|---------------------------------|-------------------------|---------|---------------------------------|----|---------|--|----|
| | | | | | | | | | | | | | | | |
| | Single circuit terminal block | | | Single circuit terminal block | | | Single circuit terminal block | | | | | | | | |
| | Catalog Number | Price Ea. (Std Pkg) | Pkg. Qty | Catalog Number | Price Ea. (Std Pkg) | Pkg. Qty | Catalog Number | Price Ea. (Std Pkg) | Pkg. Qty | | | | | | |
| Terminal - Gray | V7-W3 | 1.44 | 50 | V7-W4 | 1.65 | 50 | V7-W6 | 1.73 | 50 | | | | | | |
| Red | V7-W3-RE | 1.52 | 50 | V7-W4-RE | 1.73 | 50 | V7-W6-RE | 1.87 | 50 | | | | | | |
| Blue | V7-W3-B | | | V7-W4-B | | | V7-W6-B | | | | | | | | |
| Black | V7-W3-BL | | | V7-W4-BL | | | V7-W6-BL | | | | | | | | |
| Green | V7-W3-G | | | V7-W4-G | | | V7-W6-G | | | | | | | | |
| Yellow | V7-W3-Y | | | V7-W4-Y | | | V7-W6-Y | | | | | | | | |
| Orange | V7-W3-OR | | | V7-W4-OR | | | V7-W6-OR | | | | | | | | |
| White | V7-W3-W | | | V7-W4-W | | | V7-W6-W | | | | | | | | |
| Brown | V7-W3-BR | | | V7-W4-BR | | | V7-W6-BR | | | | | | | | |
| Accessories (also see pages N24...N29) | | | | | | | | | | | | | | | |
| End Barrier | V7-EB3 | | | | | | 50 | | | V7-EB3 | | 50 | V7-EB10 | | 50 |
| End Anchors | | | | | | | | | | | | | | | |
| DIN Rail — Normal Duty | V7-EA35 | | 50 | V7-EA35 | | 50 | V7-EA35 | | 50 | | | | | | |
| DIN Rail — Heavy Duty | V7-EAH35 | | 10 | V7-EAH35 | | 10 | V7-EAH35 | | 10 | | | | | | |
| DIN Rail — Snap-in | V7-ER35 | | 50 | V7-ER35 | | 50 | V7-ER35 | | 50 | | | | | | |
| Jumpers | | | | | | | | | | | | | | | |
| Side Jumper — 10-pole Insulated | V7-SJ5-10 | See Accessory Pages for Pricing | 10 | V7-SJ6-10 | See Accessory Pages for Pricing | 10 | V7-CJ7-40 (40 pole) | See Accessory Pages for Pricing | 5 | | | | | | |
| Center Jumper — 50-pole | V7-CJ5-50 | | 5 | V7-CJ6-50 | | 5 | | | | | | | | | |
| Center Jumper — 10-pole | V7-CJ5-10 | | 10 | V7-CJ6-10 | | 10 | | | | | | | | | |
| Center Jumper — 3-pole | V7-CJ5-3 | | 10 | V7-CJ6-3 | | 10 | | | | | | | | | |
| Center Jumper — 2-pole | V7-CJ5-2 | | 10 | V7-CJ6-2 | | 10 | | | | | | | | | |
| Center Jumper Link | V7-CJL5 | | 10 | V7-CJL6 | | 10 | | | | | | | | | |
| Center Jumper Cover — White | V7-CJCW5 ② | | 20 | V7-CJCW6 | | 20 | | | | | | | | | |
| Other Accessories | | | | | | | | | | | | | | | |
| Partition Plate | V7-PP3 | | See Accessory Pages for Pricing | 50 | | V7-PP3 | See Accessory Pages for Pricing | | 50 | V7-PP10 | See Accessory Pages for Pricing | 50 | | | |
| Separation Plate | V7-SP3 | | | 50 | | V7-SP3 | | | 50 | | | | | | |
| Test Plug | V7-TP28 | 10 | | V7-TP28 | 10 | | | | | | | | | | |
| Test Plug | V7-TP6E | 10 | | V7-TP6E | 10 | | | | | | | | | | |
| Test Plug | V7-TP6EWL | 10 | | V7-TP6EWL | 10 | | | | | | | | | | |
| Test Plug Adapter | V7-TA285 | 10 | | V7-TA40 | 10 | | | | | | | | | | |
| Electrical Warning Plate (1-pole) | V7-EWP5-4 | 10 | | V7-EWP5-4 | 10 | | | | | | | | | | |
| Screwdriver ③ | V7-SCRDRV1 | 1 | | V7-SCRDRV1 | 1 | | | | | | | | | | |
| Marking Systems ④ | | | | | | | | | | | | | | | |
| Blank Tags (cards of 100) | V7-SM5X9 | | | 5 | V7-SM6X12 | | | 5 | V7-SM6X12 | | | 5 | | | |
| | V7-SM5X12 | | 5 | | | 5 | | | 5 | | | | | | |
| Pre-printed Tags (sticks of 10) | V7-MP5 ⑤ | | 10 | V7-MP ⑤ | | 10 | V7-MP ⑤ | | 10 | | | | | | |
| Terminal Block Specifications | | | | | | | | | | | | | | | |
| Approvals | UL | UL | IEC | UL | UL | IEC | UL | UL | IEC | | | | | | |
| Voltage Rating | 600V AC/DC | 600V AC/DC | 800V AC/DC | 600V AC/DC | 600V AC/DC | 800V AC/DC | 600V AC/DC | 600V AC/DC | 800V AC/DC | | | | | | |
| Maximum Current | 20 A | 20 A | 24 A | 30 A | 30 A | 32 A | 40 A | 40 A | 41 A | | | | | | |
| Wire Range (Rated Cross Section) | #22...#14 AWG | #30...#14 AWG | 0.5...2.5mm ² | #22...#10 AWG | #22...#10 AWG | 0.5... 4mm ² | #22...#10 AWG | #22...#10 AWG | 0.5... 6mm ² | | | | | | |
| Wire Strip Length | 0.39" (10 mm) | | | 0.35" (9 mm) | | | 0.47" (12 mm) | | | | | | | | |
| Recommended Tightening Torque | 5.0...5.6 lb-in. (0.6 Nm) | | | 5.0...5.6 lb-in. (0.6 Nm) | | | 5.6...6.8 lb-in. (0.7 Nm) | | | | | | | | |
| Density | 61 pcs./ft (200/m) | | | 50 pcs./ft (166/m) | | | 43 pcs./ft (142/m) | | | | | | | | |
| Insulation Temperature Range | -40°...+195°F (-40°...+90°C) | | | -40°...+195°F (-40°...+90°C) | | | -40°...+195°F (-40°...+90°C) | | | | | | | | |
| Mounting Rail | Fits all types shown on page N30 | | | Fits all types shown on page N30 | | | Fits all types shown on page N30 | | | | | | | | |

① Special order with minimum quantities may be required for certain terminal colors.

② May only be used as a marking surface. Cannot be installed over a center jumper.

③ Specially designed to fit the screws on V7-W3, W4 and W6 terminals.

④ Custom marking tags available. See page N38 for order form.

⑤ Catalog number is not complete. See pages N36...N37.

Standard Feed-Through Blocks ①

| Ordering and Technical Information ① | 10mm ² | | | 16mm ² | | |
|---|----------------------------------|---------------------------------|-------------------------|----------------------------------|---------------------------------|-------------------------|
| | | | | | | |
| | Single circuit terminal block | | | Single circuit terminal block | | |
| | Catalog Number | Price Ea. (Std Pkg) | Pkg. Qty | Catalog Number | Price Ea. (Std Pkg) | Pkg. Qty |
| Terminal - Gray | V7-W10 | 2.14 | 50 | V7-W16S | 3.69 | 50 |
| Red | V7-W10-RE | 2.19 | 50 | V7-W16S-RE | 3.84 | 50 |
| Blue | V7-W10-B | | | V7-W16S-B | | |
| Black | V7-W10-BL | | | V7-W16S-BL | | |
| Green | V7-W10-G | | | V7-W16S-G | | |
| Yellow | V7-W10-Y | | | V7-W16S-Y | | |
| Orange | V7-W10-OR | | | V7-W16S-OR | | |
| White | V7-W10-W | | | V7-W16S-W | | |
| Brown | V7-W10-BR | | | V7-W16S-BR | | |
| Accessories (also see pages N24...N29) | | | | | | |
| End Barrier | V7-EB10 | | 50 | V7-EB10 | | 50 |
| End Anchors | | | | | | |
| DIN Rail — Normal Duty | V7-EA35 | | 50 | V7-EA35 | | 50 |
| DIN Rail — Heavy Duty | V7-EAH35 | | 10 | V7-EAH35 | | 10 |
| DIN Rail — Snap-in | V7-ER35 | | 50 | V7-ER35 | | 50 |
| Jumpers | | See Accessory Pages for Pricing | | | See Accessory Pages for Pricing | |
| Side Jumper – 10-pole Insulated | V7-SJ8-10 | | 10 | | | |
| Center Jumper – 40-pole | V7-CJ8-40 | | 5 | | | |
| Center Jumper – 10-pole | V7-CJ8-10 | | 10 | V7-CJS11-10 | | 10 |
| Center Jumper – 3-pole | V7-CJ8-3 | | 10 | V7-CJS11-3 | | 10 |
| Center Jumper – 2-pole | V7-CJ8-2 | | 10 | V7-CJS11-2 | | 10 |
| Center Jumper Link | V7-CJL8 | | 10 | | | |
| Center Jumper Cover – White ② | V7-CJCW6 | 20 | | | | |
| Other Accessories | | | | | | |
| Partition Plate | V7-PP10 | | 50 | V7-PP10 | | 50 |
| Test Plug | V7-TP28 | | 10 | | | |
| Test Plug Adapter | V7-TA40 | | 10 | | | |
| Electrical Warning Plate (1-pole) | V7-EWP8-4 | | 10 | | | |
| Group Marking Carrier | V7-GM35 | | 10 | V7-GM35 | | 1 |
| Marking Systems ③ | | | | | | |
| Blank Tags (cards of 100) | V7-SM8X12 | | 5 | V7-SM6X12 | | 5 |
| Pre-printed Tags (sticks of 10) | V7-MP ④ | | 10 | V7-MP ④ | | 10 |
| Terminal Block Specifications | | | | | | |
| Approvals | | | IEC | | | IEC |
| Voltage Rating | 600V AC/DC | 600V AC/DC | 800V AC/DC | 600V AC/DC | 600V AC/DC | 800V AC/DC |
| Maximum Current | 50 A | 50 A | 57 A | 85 A | 85 A | 76 A |
| Wire Range (Rated Cross Section) | #22...8 AWG | #22...8 AWG | 0.5...10mm ² | #14...4 AWG | #14...4 AWG | 2.5...16mm ² |
| Wire Strip Length | 0.51" (13 mm) | | | 0.51" (13 mm) | | |
| Recommended Tightening Torque | 12.2...13.4 lb-in. (1.4 Nm) | | | 18...20 lb-in. (2.1 Nm) | | |
| Density | 38 pcs./ft (125/m) | | | 27 pcs./ft (90/m) | | |
| Insulation Temperature Range | -40...+195°F (-40...+90°C) | | | -40...+195°F (-40...+90°C) | | |
| Mounting Rail | Fits all types shown on page N30 | | | Fits all types shown on page N30 | | |

- ① Special order with minimum quantities may be required for certain terminal colors.
- ② May only be used as a marking surface. Cannot be installed over a center jumper.
- ③ Custom marking tags available. See page N38 for order form.
- ④ Catalog number is not complete. See pages N36...N37.

Standard Feed-Through Blocks ①

| Ordering and Technical Information ① | 35mm ² | | | 70mm ² | | |
|---|----------------------------------|---------------------------------|-------------------------------|----------------------------------|---------------------------------|---------------------------|
| | | | Single circuit terminal block | | Single circuit terminal block | |
| | Catalog Number | Price Ea. (Std Pkg) | Pkg. Qty | Catalog Number | Price Ea. (Std Pkg) | Pkg. Qty |
| Terminal - Gray | V7-W35 | 8.01 | 10 | V7-W70 | 23.52 | 5 |
| Terminal - Blue | V7-W35-B | 8.55 | 10 | V7-W70-B | 23.52 | 5 |
| Accessories (also see pages N24...N29) | | | | | | |
| End Barrier | V7-EB35 | | 25 | Not Required | | |
| End Anchors | | | | | | |
| DIN Rail — Normal Duty | V7-EA35 | See Accessory Pages for Pricing | 50 | | See Accessory Pages for Pricing | 10 |
| DIN Rail — Heavy Duty | V7-EAH35 | | 10 | V7-EAH35 | | |
| DIN Rail — Snap-in | V7-ER35 | | 50 | | | |
| Jumpers | | | | | | |
| Center Jumper – 3-pole | V7-CJ14-3 | | 10 | | | |
| Center Jumper – 2-pole | V7-CJ14-2 | | 10 | | | |
| Other Accessories | | | | | | |
| Partition Plate | V7-PP35 | | 25 | | | |
| Group Marking Carrier | V7-GM35 | | 10 | V7-GM35 | | 10 |
| Marking Systems ② | | | | | | |
| Blank Tags (cards of 100) | V7-SM6X12 | | 5 | V7-SM6X12 | | 5 |
| Pre-printed Tags (sticks of 10) | V7-MP ③ | | 10 | V7-MP ③ | | 10 |
| Terminal Block Specifications | | | | | | |
| Approvals | | | IEC | | | IEC |
| Voltage Rating | 600V AC/DC | 600V AC/DC | 750V AC/DC | 600V AC/DC | 600V AC/DC | 750V AC/DC |
| Maximum Current | 140 A | 125 A | 138 A | 310 A | 200 A | 175 A |
| Wire Range (Rated Cross Section) | #14... #1/0 AWG | #14... #1/0 AWG | 2.5...35 mm ² | #4... #3/0 AWG | #4... #3/0 AWG | 4...70 mm ² |
| Wire Strip Length | 0.67" (17 mm) | | | 1.02" (26 mm) | | |
| Recommended Tightening Torque | 22.1lb-in. (2.5 Nm) | | | 132.8 lb-in. (15 Nm) | | |
| Density | 21 pcs./ft (71/m) | | | 13 pcs./ft (43/m) | | |
| Insulation Temperature Range | -40°...+195°F (-40°...+90°C) | | | -40°...+195°F (-40°...+90°C) | | |
| Mounting Rail | Fits all types shown on page N30 | | | Fits all types shown on page N30 | | |





- ① Special order with minimum quantities may be required for certain terminal colors.
- ② Custom marking tags available. See page N38 for order form.
- ③ Catalog number is not complete. See pages N36...N37.

Specialty Feed-Through Blocks

| Ordering and Technical Information ① | 2.5mm ² | | | 4mm ² | | | 6mm ² | | | | |
|---|----------------------------------|---------------------------------|------------------------------|----------------------------------|---------------------------------|--------------------------|----------------------------------|---------------------------------|-------------------------|--|--|
| | | | | | | | | | | | |
| | Two circuit terminal block | | | Two circuit terminal block | | | Two circuit terminal block | | | | |
| | Catalog Number | Price Ea. (Std Pkg) | Pkg. Qty | Catalog Number | Price Ea. (Std Pkg) | Pkg. Qty | Catalog Number | Price Ea. (Std Pkg) | Pkg. Qty | | |
| Terminal - Gray Blue | V7-WD3 | 3.48 | 50 | V7-WD4 V7-WD4-B ② | 3.20 3.32 | 50 | V7-WD6 | 6.15 | 20 | | |
| Accessories (also see pages N24...N29) | | | | | | | | | | | |
| End Barrier | V7-EBD3 | | 50 | V7-EBD3 | | 50 | V7-EBD6 | | 50 | | |
| End Anchors | | | | | | | | | | | |
| DIN Rail — Normal Duty | V7-EA35 | | 50 | V7-EA35 | | 50 | V7-EA35 | | 50 | | |
| DIN Rail — Heavy Duty | V7-EAH35 | | 10 | V7-EAH35 | | 10 | V7-EAH35 | | 10 | | |
| DIN Rail — Snap-in | V7-ER35 | | 50 | V7-ER35 | | 50 | V7-ER35 | | 50 | | |
| Jumpers | | | | | | | | | | | |
| Side Jumper – 10-pole | V7-SJ5-10 | See Accessory Pages for Pricing | 10 | V7-SJ6-10 | See Accessory Pages for Pricing | 10 | | See Accessory Pages for Pricing | | | |
| Center Jumper – 50-pole | V7-CJD5-50 | | 5 | V7-CJD6-50 | | 5 | | | | | |
| Center Jumper – 40-pole | | | | | | | V7-CJ7-40 | | 5 | | |
| Center Jumper – 10-pole | V7-CJD5-10 | | 10 | V7-CJD6-10 | | 10 | V7-CJ7-10 | | 10 | | |
| Center Jumper – 3-pole | V7-CJD5-3 | | 10 | V7-CJD6-3 | | 10 | V7-CJ7-3 | | 10 | | |
| Center Jumper – 2-pole | V7-CJD5-2 | | 10 | V7-CJD6-2 | | 10 | V7-CJ7-2 | | 10 | | |
| Center Jumper Link | V7-CJL5 | | 10 | V7-CJDL6 | | 10 | V7-CJL7 | | 10 | | |
| Other Accessories | | | | | | | | | | | |
| Partition Plate | V7-PPD3 | | 50 | V7-PPD3 | | 50 | V7-PPD6 | | 50 | | |
| Separation Plate | V7-SPD3 | | 50 | V7-SPD3 | | 50 | | | | | |
| Test Plug | | | | V7-TP28 | 10 | V7-TP28 | 10 | | | | |
| Test Plug Adapter | V7-TA285 | 10 | V7-TA40 | 10 | V7-TA40 | 10 | | | | | |
| Electrical Warning Plate (1-pole) | V7-EWP5-4 | 10 | V7-EWP6-4 | 10 | V7-EWP7-4 | 10 | | | | | |
| Group Marking Carrier | V7-GM35 | 10 | V7-GM35 | 10 | V7-GM35 | 5 | | | | | |
| Marking Systems ③ | | | | | | | | | | | |
| Blank Tags (cards of 100) | V7-SM5X9 | | 5 | V7-SM6X9 | | 5 | V7-SM6X12 | | 5 | | |
| Pre-printed Tags (sticks of 10) | V7-MP5 ③ | | 10 | V7-MP ③ | | 10 | V7-MP ③ | | 10 | | |
| Terminal Block Specifications | | | | | | | | | | | |
| Approvals | UL | UL | IEC | UL | UL | IEC | UL | UL | IEC | | |
| Voltage Rating | 300V AC/DC | 300V AC/DC | 500V AC/DC | 300V AC/DC | 300V AC/DC | 500V AC/DC | 300V AC/DC | 300V AC/DC | 550V AC/DC | | |
| Maximum Current | 15 A | 15 A | 24 A | 20 A | 20 A | 32 A | 55 A | 50 A | 41 A | | |
| Wire Range (Rated Cross Section) | #22... #14 AWG | #30... #14 AWG | 0.5...2.5 2.5mm ² | #22... #12 AWG | #22... #10 AWG | 0.5...4 4mm ² | #18... #8 AWG | #18... #8 AWG | 0.5...6 mm ² | | |
| Wire Strip Length | 0.39" (10 mm) | | | 0.39" (9 mm) | | | 0.35" (9 mm) | | | | |
| Recommended Tightening Torque | 5.0...5.6 lb-in. (0.6 Nm) | | | 5.0...5.6 lb-in. (0.6 Nm) | | | 6.2 lb-in. (0.7 Nm) | | | | |
| Density | 60 pcs./ft (200/m) | | | 50 pcs./ft (166/m) | | | 43 pcs./ft (142/m) | | | | |
| Insulation Temperature Range | -40°...+195°F (-40°...+90°C) | | | -40°...+195°F (-40°...+90°C) | | | -40°...+195°F (-40°...+90°C) | | | | |
| Mounting Rail | Fits all types shown on page N30 | | | Fits all types shown on page N30 | | | Fits all types shown on page N30 | | | | |

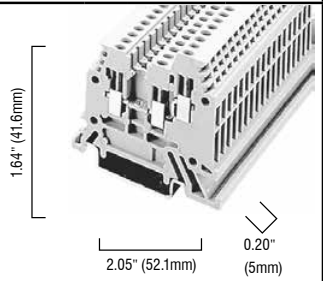
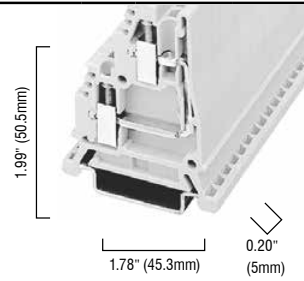
- ① Special order with minimum quantities may be required for certain terminal colors.
- ② Custom marking tags available. See page N38 for order form.
- ③ Catalog number is not complete. See pages N36...N37.

Specialty Feed-Through Blocks ①

| Ordering and Technical Information ① | 2.5mm ² | | | 2.5mm ² | | |
|---|---|---|---------------------------|--|---|---------------------------|
| |  | | |  | | |
| | Single circuit three conductor terminal block | | | Single circuit terminal block with terminals on common side. | | |
| | Catalog Number | Price Ea. (Std Pkg) | Pkg. Qty | Catalog Number | Price Ea. (Std Pkg) | Pkg. Qty |
| Terminal - Gray Blue | V7-W3TW V7-W3TW-B | 2.52 2.74 | 50 50 | V7-WR3 | 2.52 | 50 |
| Accessories (also see pages N24...N29) | | | | | | |
| End Barrier | V7-EB3TW | | 50 | V7-EBR3 | | 50 |
| End Anchors | | | | | | |
| DIN Rail — Normal Duty | V7-EA35 | | 50 | V7-EA35 | | 50 |
| DIN Rail — Heavy Duty | V7-EAH35 | | 10 | V7-EAH35 | | 10 |
| DIN Rail — Snap-in | V7-ER35 | | 50 | V7-ER35 | | 50 |
| Jumpers | | | | | | |
| Side Jumper – 10-pole Insulated | V7-SJ5-10 ② | See Accessory Pages for Pricing | 10 | V7-SJ5-10 | See Accessory Pages for Pricing | 10 |
| Center Jumper – 50-pole | V7-CJ5-50 | | 5 | V7-CJD5-50 | | 5 |
| Center Jumper – 10-pole | V7-CJ5-10 | | 10 | V7-CJD5-10 | | 10 |
| Center Jumper – 3-pole | V7-CJ5-3 | | 10 | V7-CJD5-3 | | 10 |
| Center Jumper – 2-pole | V7-CJ5-2 | | 10 | V7-CJD5-2 | | 10 |
| Center Jumper Link | V7-CJL5 | | 10 | V7-CJL5 | | 10 |
| Center Jumper Cover – White ③ | V7-CJCW5 | | 20 | V7-CJCW5 | | 20 |
| Other Accessories | | | | | | |
| Partition Plate | V7-PP10 | | 50 | V7-EBR3 | | 50 |
| Test Plug Adapter | V7-TA285 | | 10 | V7-TA285 | | 10 |
| Electrical Warning Plate (1-pole) | V7-EWP5-4 | | 10 | V7-EWP5-4 | | 10 |
| Group Marking Carrier | V7-GM35 | | 10 | V7-GM35 | | 10 |
| Marking Systems ④ | | | | | | |
| Blank Tags (cards of 100) | V7-SM5X9 | | 5 | V7-SM5X9 | | 5 |
| Pre-printed Tags (sticks of 10) | V7-MP5 ⑤ | | 10 | V7-MP5 ⑤ | | 10 |
| Terminal Block Specifications | | | | | | |
| Approvals |  |  | IEC |  |  | IEC |
| Voltage Rating | 600V AC/DC | 600V AC/DC | 800V AC/DC | 300V AC/DC | 300V AC/DC | 500V AC/DC |
| Maximum Current | 15 A | 15 A | 24 A | 15 A | 15 A | 24 A |
| Wire Range (Rated Cross Section) | #22... #14 AWG | #30... #14 AWG | 0.5...2.5 mm ² | #22... #14 AWG | #22... #14 AWG | 0.5...2.5 mm ² |
| Wire Strip Length | 0.35" (9 mm) | | | 0.39" (10 mm) | | |
| Recommended Tightening Torque | 4.2...4.6 lb-in. (0.5 Nm) | | | 5.0...5.6 lb-in. (0.6 Nm) | | |
| Density | 61 pcs./ft (200/m) | | | 61 pcs./ft (200/m) | | |
| Insulation Temperature Range | -40°...+195°F (-40°...+90°C) | | | -40°...+195°F (-40°...+90°C) | | |
| Mounting Rail | Fits all types shown on page N30 | | | Fits all types shown on page N30 | | |

① Special order with minimum quantities may be required for certain terminal colors.

② Use side jumpers on the single conductor side only.

③ May only be used as a marking surface. Cannot be installed over a center jumper.

④ Custom marking tags available. See page N38 for order form.

⑤ Catalog number is not complete. See pages N36...N37.

Grounding Blocks

| Ordering and Technical Information ① | 4mm ² | | | 6mm ² | | | 10mm ² | | |
|---|---|---------------------------------|-------------------|---|---------------------------------|-------------------|---|---------------------------------|--------------------|
| | | | | | | | | | |
| | Single circuit grounding terminal block | | | Single circuit grounding terminal block | | | Single circuit grounding terminal block | | |
| | Catalog Number | Price Ea. (Std Pkg) | Pkg. Qty | Catalog Number | Price Ea. (Std Pkg) | Pkg. Qty | Catalog Number | Price Ea. (Std Pkg) | Pkg. Qty |
| Terminal - green/yellow | V7-WG4 | 4.81 | 50 | V7-WG6 | 5.08 | 50 | V7-WG10S | 6.15 | 10 |
| Accessories (also see pages N24...N29) | | | | | | | | | |
| End Barrier | V7-EB3-Y | | 50 | V7-EB10-Y | | 50 | V7-EB10-Y | | 50 |
| End Anchors | | See Accessory Pages for Pricing | | | See Accessory Pages for Pricing | | | See Accessory Pages for Pricing | |
| DIN Rail — Normal Duty | V7-EA35 | | 50 | V7-EA35 | | 50 | V7-EA35 | | 50 |
| DIN Rail — Heavy Duty | V7-EAH35 | | 10 | V7-EAH35 | | 10 | V7-EAH35 | | 10 |
| DIN Rail — Snap-in | V7-ER35 | 50 | V7-ER35 | 50 | V7-ER35 | 50 | | | |
| Other Accessories | | | | | | | | | |
| Group Marking Carrier | V7-GM35 | | 10 | V7-GM35 | | 10 | V7-GM35 | | 10 |
| Marking Systems ② | | | | | | | | | |
| Blank Tags (cards of 100) | V7-SM6X12 | | 5 | V7-SM6X12 | | 5 | V7-SM8X12 | | 5 |
| Pre-printed Tags (sticks of 10) | V7-MP ③ | | 10 | V7-MP ③ | | 10 | | | |
| Terminal Block Specifications | | | | | | | | | |
| Approvals | UL | UL | IEC | UL | UL | IEC | UL | UL | IEC |
| Voltage Rating | ~ | ~ | ~ | ~ | ~ | ~ | ~ | ~ | ~ |
| Maximum Current | Grounding | | | Grounding | | | Grounding | | |
| Wire Range (Rated Cross Section) | #22... #14 AWG | #22... #12 AWG | 4 mm ² | #22... #10 AWG | #22... #10 AWG | 6 mm ² | #22... #8 AWG | #22... #8 AWG | 10 mm ² |
| Wire Strip Length | 0.43" (11 mm) | | | 0.47" (12 mm) | | | 0.43" (11 mm) | | |
| Recommended Tightening Torque | 5.6...6.8 lb-in. (0.7 Nm) | | | 5.6...6.8 lb-in. (0.7 Nm) | | | 7.1 lb-in. (0.8 Nm) | | |
| Density | 50 pcs./ft (166/m) | | | 43 pcs./ft (142/m) | | | 38 pcs./ft (125/m) | | |
| Insulation Temperature Range | -40°...+195°F (-40°...+90°C) | | | -40°...+195°F (-40°...+90°C) | | | -40°...+195°F (-40°...+90°C) | | |
| Mounting Rail | Fits all types shown on page N30 | | | Fits all types shown on page N30 | | | Fits all types shown on page N30 | | |

① Refer to pages N24...N29 for a listing of all V7-W accessories.
 ② Custom marking tags available. See page N38 for order form.
 ③ Catalog number is not complete. See pages N36...N37.

Grounding Blocks

| Ordering and Technical Information ① | 16mm ² | | | 35mm ² | | | 70mm ² | | |
|---|---|------------------|--------------------|---|-------------------|--------------------|---|-------------------|--------------------|
| | | | | | | | | | |
| | Single circuit grounding terminal block | | | Single circuit grounding terminal block | | | Single circuit grounding terminal block | | |
| Catalog Number | Price Ea. (Std Pkg) | Pkg. Qty | Catalog Number | Price Ea. (Std Pkg) | Pkg. Qty | Catalog Number | Price Ea. (Std Pkg) | Pkg. Qty | |
| Terminal - green/yellow | V7-WG16 | 8.55 | 10 | V7-WG35 | 11.36 | 10 | V7-WG70 | 26.72 | 5 |
| Accessories (also see pages N24...N29) | | | | | | | | | |
| End Barrier | Not Required | | | Not Required | | | Not Required | | |
| End Anchors | Not Required | | | Not Required | | | Not Required | | |
| DIN Rail — Normal Duty | Not Required | | | Not Required | | | Not Required | | |
| DIN Rail — Heavy Duty | Not Required | | | Not Required | | | Not Required | | |
| Other Accessories | See Accessory Pages for Pricing | | | See Accessory Pages for Pricing | | | See Accessory Pages for Pricing | | |
| Group Marking Carrier | V7-GM35 | | 10 | V7-GM35 | | 10 | V7-GM35 | | 10 |
| Marking Systems ② | See Accessory Pages for Pricing | | | See Accessory Pages for Pricing | | | See Accessory Pages for Pricing | | |
| Blank Tags (cards of 100) | V7-SM6X12 | | 5 | V7-SM6X12 | | 5 | V7-SM6X12 | | 5 |
| Pre-printed Tags (sticks of 10) | V7-MP ③ | | 10 | V7-MP ③ | | 10 | V7-MP ③ | | 10 |
| Terminal Block Specifications | | | | | | | | | |
| Approvals | UL | UL | IEC | UL | UL | IEC | UL | UL | IEC |
| Voltage Rating | ~ | ~ | ~ | ~ | ~ | ~ | ~ | ~ | ~ |
| Maximum Current | Grounding | | | Grounding | | | Grounding | | |
| Wire Range (Rated Cross Section) | #10... #4 AWG | #10... #4 AWG | 16 mm ² | #6... #1/0 AWG | #6... #1/0 AWG | 35 mm ² | #4... #2/0 AWG | #4... #2/0 AWG | 70 mm ² |
| Wire Strip Length | 0.70" (18 mm) | | | 0.83" (21 mm) | | | 1.02" (26 mm) | | |
| Recommended Tightening Torque | 22.1 lb-in. (2.5 Nm) | | | 44.3 lb-in. (5.0 Nm) | | | 132 lb-in. (15 Nm) | | |
| Density | 23 pcs./ft (76/m) | | | 16 pcs./ft (55/m) | | | 13 pcs./ft (42/m) | | |
| Insulation Temperature Range | -40°...+195°F (-40°...+90°C) | | | -40°...+195°F (-40°...+90°C) | | | -40°...+195°F (-40°...+90°C) | | |
| Mounting Rail | Fits all types shown on page N30 | | | Fits all types shown on page N30 | | | Fits all types shown on page N30 | | |

① Refer to pages N24...N29 for a listing of all V7-W accessories.
 ② Custom marking tags available. See page N38 for order form.
 ③ Catalog number is not complete. See pages N36...N37.

Two Level Grounding Block

| | | | |
|---|------------------------------------|---------------------------------|-----------------|
| Ordering and Technical Information ❶ | | | |
| | Two level grounding terminal block | | |
| | Catalog Number | Price Ea. (Std Pkg) | Pkg. Qty |
| Terminal - green/yellow | V7-WDG4C | 6.15 | 50 |
| Accessories (also see pages N24...N29) | | | |
| End Barrier | V7-EBD3-Y | | 50 |
| End Anchors | | See Accessory Pages for Pricing | |
| DIN Rail — Normal Duty | V7-EA35 | | 50 |
| DIN Rail — Heavy Duty | V7-EAH35 | | 10 |
| DIN Rail — Snap-in | V7-ER35 | | 50 |
| Jumpers | | | |
| Side Jumper - 10 pole insulated | V7-SJ6-10 | | 10 |
| Other Accessories | | | |
| Partition Plate | V7-PPD3 | | 50 |
| Group Marking Carrier | V7-GM35 | | 10 |
| Marking Systems ❷ | | | |
| Blank Tags (cards of 100) | V7-SM6X9 | | 5 |
| Pre-printed Tags (sticks of 10) | V7-MP ❸ | | 10 |
| Terminal Block Specifications | | | |
| Approvals | c us | IEC | |
| Voltage Rating | 300V AC/DC | 500V AC/DC | |
| Maximum Current | 20A | 32A | |
| Wire Range (Rated Cross Section) | #22...12 AWG | 0.05...4mm² | |
| Wire Strip Length | 0.39" (10mm) | | |
| Recommended Tightening Torque | 5.0...5.6 lb-in. (0.6 Nm) | | |
| Density | 50 pcs./ft (166/m) | | |
| Insulation Temperature Range | -40°...+195°F (-40°...90°C) | | |
| Mounting Rail | Fits all types shown on page N30 | | |

❶ Refer to pages N24...N29 for a listing of all V7-W accessories.
 ❷ Custom marking tags available. See page N38 for order form.
 ❸ Catalog number is not complete. See pages N36...N37.

Fuse Blocks

| Ordering and Technical Information ① | 4mm ² | | | 4mm ² | | | 4mm ² | | |
|---|--|---------------------|--------------------------|--|---------------------|--------------------------|--|---------------------|--------------------------|
| | | | | | | | | | |
| | Single circuit fuse block | | | Single circuit fuse block with LED blown fuse indication | | | Single circuit fuse block with neon blown fuse indication | | |
| | Catalog Number | Price Ea. (Std Pkg) | Pkg. Qty | Catalog Number | Price Ea. (Std Pkg) | Pkg. Qty | Catalog Number | Price Ea. (Std Pkg) | Pkg. Qty |
| Terminal | V7-WFB4 | 7.48 | 50 | V7-WFB424 | 14.03 | 50 | V7-WFB4250 | 14.03 | 50 |
| Accessories (also see pages N24...N29) | | | | | | | | | |
| End Barrier | Not Required | | | Not Required | | | Not Required | | |
| End Anchors | DIN Rail — Normal Duty DIN Rail — Heavy Duty DIN Rail — Snap-in | | | DIN Rail — Normal Duty DIN Rail — Heavy Duty DIN Rail — Snap-in | | | DIN Rail — Normal Duty DIN Rail — Heavy Duty DIN Rail — Snap-in | | |
| Jumpers | Side Jumper – 10-pole | | | Side Jumper – 10-pole | | | Side Jumper – 10-pole | | |
| Other Accessories | Partition Plate Group Marking Carrier | | | Partition Plate Group Marking Carrier | | | Partition Plate Group Marking Carrier | | |
| Marking Systems ② | Blank Tags (cards of 100) For Handle Pre-printed Tags (sticks of 10) | | | Blank Tags (cards of 100) For Handle Pre-printed Tags (sticks of 10) | | | Blank Tags (cards of 100) For Handle Pre-printed Tags (sticks of 10) | | |
| Terminal Block Specifications | | | | | | | | | |
| Approvals | UL | UL | IEC | UL | UL | IEC | UL | UL | IEC |
| Voltage Rating | 300V AC/DC | 300V AC/DC | 500V AC/DC | 300V AC/DC | 300V AC/DC | 500V AC/DC | 300V AC/DC | 300V AC/DC | 500V AC/DC |
| Maximum Current | 15 A | 15 A | 15 A ④ | 15 A | 15 A | 15 A ④ | 15 A | 15 A | 15 A ④ |
| Wire Range (Rated Cross Section) | #22... #12 AWG | #22... #12 AWG | 0.05...4 mm ² | #22... #12 AWG | #22... #12 AWG | 0.05...4 mm ² | #22... #12 AWG | #22... #12 AWG | 0.05...4 mm ² |
| Indicator Type | Non-Indicating | | | LED | | | Neon | | |
| Leakage Current | ~ | | | 2m A @ 24V | | | 1m A @ 264V AC | | |
| Working Voltage | Per Fuse Rating | | | 10...57V AC/DC | | | 85...264V AC | | |
| Fuse Size (Not Supplied) | 5 x 20 mm | | | 5 x 20 mm | | | 5 x 20 mm | | |
| Wire Strip Length | 0.31" (8mm) | | | 0.31" (8mm) | | | 0.31" (8mm) | | |
| Recommended Tightening Torque | 5.0...5.6 lb.-in. (0.6 Nm) | | | 5.0...5.6 lb.-in. (0.6 Nm) | | | 5.0...5.6 lb.-in. (0.6 Nm) | | |
| Density | 38 pcs./ft (125/m) | | | 38 pcs./ft (125/m) | | | 38 pcs./ft (125/m) | | |
| Insulation Temperature Range | -40°...+195°F (-40...+90° C) | | | -40°...+195°F (-40...+90° C) | | | -40°...+195°F (-40...+90° C) | | |
| Mounting Rail | Fits all types shown on page N30 | | | Fits all types shown on page N30 | | | Fits all types shown on page N30 | | |

- ① Refer to pages N24...N29 for a listing of all V7-W accessories.
- ② Custom marking tags available. See page N38 for order form.
- ③ Catalog number is not complete. See pages N36...N37.
- ④ IEC standards for 5 x 20 mm fuses do not include ratings above 6.3 A.

Fuse Blocks

| Ordering and Technical Information ① | 4mm ² | | | 4mm ² | | | 4mm ² | | |
|---|--|---------------------------------|----------------------------|---|---------------------------------|--------------------------|--|---------------------------------|--------------------------|
| | | | | | | | | | |
| | Single circuit fusible terminal block with neon blown fuse indicator | | | Single circuit fusible terminal block with LED blown fuse indicator | | | Single circuit fusible terminal block without a blown fuse indicator | | |
| Terminal | Catalog Number | Price Ea. (Std Pkg) | Pkg. Qty | Catalog Number | Price Ea. (Std Pkg) | Pkg. Qty | Catalog Number | Price Ea. (Std Pkg) | Pkg. Qty |
| | V7-H4 | 10.15 | 25 | V7-H5 | 14.03 | 25 | V7-H6 | 7.48 | 25 |
| Accessories (also see pages N24...N29) | | | | | | | | | |
| End Barrier | V7-N37 | | 50 | V7-N37 | | 50 | V7-N37 | | 50 |
| End Anchors | V7-EA35 | See Accessory Pages for Pricing | 50 | V7-EA35 | See Accessory Pages for Pricing | 50 | V7-EA35 | See Accessory Pages for Pricing | 50 |
| DIN Rail — Normal Duty | V7-EAH35 | | 10 | V7-EAH35 | | 10 | V7-EAH35 | | 10 |
| DIN Rail — Heavy Duty | V7-ER35 | | 50 | V7-ER35 | | 50 | V7-ER35 | | 50 |
| Jumpers | V7-N49 | See Accessory Pages for Pricing | 10 | V7-N49 | See Accessory Pages for Pricing | 10 | V7-N49 | See Accessory Pages for Pricing | 10 |
| Side Jumper — 10-pole Uninsulated | V7-SJS | | 10 | V7-SJS | | 10 | V7-SJS | | 10 |
| Other Accessories | V7-GM35 | See Accessory Pages for Pricing | 10 | V7-GM35 | See Accessory Pages for Pricing | 10 | V7-GM35 | See Accessory Pages for Pricing | 10 |
| Group Marking Carrier | V7-SM8X12 | | 5 | V7-SM8X12 | | 5 | V7-SM8X12 | | 5 |
| Marking Systems ② | V7-SM8X12 | | 5 | V7-SM8X12 | | 5 | V7-SM8X12 | | 5 |
| Terminal Block Specifications | | | | | | | | | |
| Approvals | | | IEC | | | IEC | | | IEC |
| Voltage Rating | 300V AC/DC | 300V AC/DC | 500V AC/DC | 300V AC/DC | 300V AC/DC | 500V AC/DC | 300V AC/DC | 300V AC/DC | 500V AC/DC |
| Maximum Current | 12 A | 12 A | 12 A | 12 A | 12 A | 12 A | 12 A | 12 A | 12 A |
| Wire Range (Rated Cross Section) | #30... #12 AWG | #30... #12 AWG | 0.05...2.5 mm ² | #30... #12 AWG | #30... #12 AWG | 0.05...4 mm ² | #30... #12 AWG | #30... #12 AWG | 0.05...4 mm ² |
| Indicator Type | Neon | | | LED | | | Non-Indicating | | |
| Leakage Current | 2m A @ 300V | | | 2m A @ 24V | | | | | |
| Working Voltage | 100...300V AC/DC | | | 10...57V AC/DC | | | Per Fuse Rating | | |
| Fuse Size (Not Supplied) | 1/4" x 1-1/4" | | | 1/4" x 1-1/4" | | | 1/4" x 1-1/4" | | |
| Wire Strip Length | 0.38" (9.7 mm) | | | 0.38" (9.7 mm) | | | 0.38" (9.7 mm) | | |
| Recommended Tightening Torque | 3...7 lb.-in. (0.3...0.8 Nm) | | | 3...7 lb.-in. (0.3...0.8 Nm) | | | 3...7 lb.-in. (0.3...0.8 Nm) | | |
| Density | 33 pcs./ft (109/m) | | | 33 pcs./ft (109/m) | | | 33 pcs./ft (109/m) | | |
| Insulation Temperature Range | -40°...+221°F (-40...+105° C) | | | -40°...+221°F (-40...+105° C) | | | -40°...+221°F (-40...+105° C) | | |
| Mounting Rail | Fits all types shown on page N30 | | | Fits all types shown on page N30 | | | Fits all types shown on page N30 | | |

① Refer to pages N24...N29 for a listing of all V7-W accessories.
 ② Custom marking tags available. See page N38 for order form.

Fuse Blocks

| Ordering and Technical Information ① | 4mm ² | | | 4mm ² | | |
|---|----------------------------------|---------------------------------|----------------------------------|---------------------------|---------------------------------|----------|
| | | | | | | |
| | Single circuit fuse block | | | Single circuit fuse block | | |
| | Catalog Number | Price Ea. (Std Pkg) | Pkg. Qty | Catalog Number | Price Ea. (Std Pkg) | Pkg. Qty |
| Terminal | V7-WFB10V | 8.96 | 25 | V7-WFB10VA | 8.96 | 25 |
| Accessories (also see pages N24...N29) | | | | | | |
| End Barrier | V7-EBFB10V | | 50 | V7-EBFB10V | | 50 |
| End Anchors | | See Accessory Pages for Pricing | | | See Accessory Pages for Pricing | |
| DIN Rail — Normal Duty | V7-EA35 | | 50 | V7-EA35 | | 50 |
| DIN Rail — Heavy Duty | V7-EAH35 | | 10 | V7-EAH35 | | 10 |
| DIN Rail — Snap-in | V7-ER35 | 50 | V7-ER35 | 50 | | |
| Other Accessories | | See Accessory Pages for Pricing | | | See Accessory Pages for Pricing | |
| Replacement Fuse Knob | V7-FCA | | 5 | V7-FCA | | 5 |
| Group Marking Carrier | V7-GM35 | 10 | V7-GM35 | 10 | | |
| Marking Systems ② | | See Accessory Pages for Pricing | | | See Accessory Pages for Pricing | |
| Blank Tags (cards of 100) | V7-SM6X12 | | 5 | V7-SM6X12 | | 5 |
| Pre-printed Tags (sticks of 10) | V7-MP ③ | 10 | V7-MP ③ | 10 | | |
| Terminal Block Specifications | | | | | | |
| Approvals | | IEC | | IEC | | |
| Voltage Rating | 300V | 250V | 300V | 250V | | |
| | AC/DC | AC/DC | AC/DC | AC/DC | | |
| Maximum Current | 10 A | 10 A | 10 A | 10 A | | |
| Wire Range (Rated Cross Section) | #20...8 AWG | 10mm ² | #20...8 AWG | 10mm ² | | |
| Indicator Type | Non-Indicating | | Non-Indicating | | | |
| Leakage Current | ~ | | ~ | | | |
| Working Voltage | Per Fuse Rating | | Per Fuse Rating | | | |
| Fuse Size (Not Supplied) | 5 x 20 mm | | 1/4 in. x 1-1/4 in. (6.3 x 32mm) | | | |
| Wire Strip Length | 0.51" (13 mm) | | 0.51" (13 mm) | | | |
| Recommended Tightening Torque | 13 lb-in. (1.5 Nm) | | 13 lb-in. (1.5 Nm) | | | |
| Density | 23 pcs./ft (75/m) | | 23 pcs./ft (75/m) | | | |
| Insulation Temperature Range | -40°...+195°F (-40°...+90°C) | | -40°...+195°F (-40°...+90°C) | | | |
| Mounting Rail | Fits all types shown on page N30 | | Fits all types shown on page N30 | | | |

- ① Refer to pages N24...N29 for a listing of all V7-W accessories.
- ② Custom marking tags available. See page N38 for order form.
- ③ Catalog number is not complete. See pages N36...N37.

Isolation Blocks

| Ordering and Technical Information | 2.5mm ² | | | 2.5mm ² | | | 6mm ² | | |
|---|--------------------------------------|---------------------------------|---------------------------|--|---------------------------------|---------------------------|--------------------------------------|---------------------------------|-------------------------|
| | | | | | | | | | |
| | Knife style isolating terminal block | | | Knife style isolating terminal block with test plug screws | | | Knife style isolating terminal block | | |
| | Catalog Number | Price Ea. (Std Pkg) | Pkg. Qty | Catalog Number | Price Ea. (Std Pkg) | Pkg. Qty | Catalog Number | Price Ea. (Std Pkg) | Pkg. Qty |
| Terminal - Gray | V7-WKD3 | 4.22 | 50 | V7-WKD3TP | 5.43 | 50 | V7-WKD6 | 11.36 | 20 |
| Accessories (also see pages N24...N29) | | | | | | | | | |
| End Barrier | V7-EBKD3 | | 50 | V7-EBKD3 | | 50 | Not Required | | |
| End Anchors | | | | | | | | | |
| DIN Rail — Normal Duty | V7-EA35 | See Accessory Pages for Pricing | 50 | V7-EA35 | See Accessory Pages for Pricing | 50 | V7-EA35 | See Accessory Pages for Pricing | 50 |
| DIN Rail — Heavy Duty | V7-EAH35 | | 10 | V7-EAH35 | | 10 | V7-EAH35 | | 10 |
| DIN Rail — Snap-in | V7-ER35 | | 50 | V7-ER35 | | 50 | V7-ER35 | | 50 |
| Jumpers | | | | | | | | | |
| Side jumper - 10-pole insulated | V7-SJ5-10 | | 10 | V7-SJ5-10 | | 10 | | | |
| Other Accessories | | | | | | | | | |
| Partition Plate | V7-PPSL3 | | 50 | V7-PPSL3 | | 50 | | | |
| Test Plug | | | | V7-TP15 | | 10 | | | |
| Group Marking Carrier | V7-GM35 | | 10 | V7-GM35 | | 10 | V7-GM35 | | 10 |
| Marking Systems | | | | | | | | | |
| Blank Tags (cards of 100) | V7-SM5X9 | | 5 | V7-SM5X9 | | 5 | V7-SM6X12 | | 5 |
| Pre-printed Tags (sticks of 10) | V7-MP5 | | 10 | V7-MP5 | | 10 | V7-MP5 | | 10 |
| Terminal Block Specifications | | | | | | | | | |
| Approvals | | | IEC | | | IEC | | | IEC |
| Voltage Rating | 600V AC/DC | 600V AC/DC | 800V AC/DC | 300V AC/DC | 300V AC/DC | 800V AC/DC | 600V AC/DC | 600V AC/DC | 800V AC/DC |
| Maximum Current | 15A | 15A | 15A | 15A | 15A | 15A | 30A | 30A | 32A |
| Wire Range (Rated Cross Section) | #22... #14 AWG | #22... #14 AWG | 0.5...2.5 mm ² | #22... #14 AWG | #22... #14 AWG | 0.5...2.5 mm ² | #18... #10 AWG | #18... #10 AWG | 0.5...6 mm ² |
| Wire Strip Length | 0.35" (9 mm) | | | 0.35" (9 mm) | | | 0.55" (14 mm) | | |
| Recommended Tightening Torque | 5.0...5.6 lb-in. (0.6 Nm) | | | 5.0...5.6 lb-in. (0.6 Nm) | | | 7.1 lb-in. (0.8 Nm) | | |
| Density | 61 pcs./ft (200/m) | | | 61 pcs./ft (200/m) | | | 33 pcs./ft (111/m) | | |
| Insulation Temperature Range | -40°...+195°F (-40°...+90°C) | | | -40°...+195°F (-40°...+90°C) | | | -40°...+195°F (-40°...+90°C) | | |
| Mounting Rail | Fits all types shown on page N30 | | | Fits all types shown on page N30 | | | Fits all types shown on page N30 | | |

- ① Refer to pages N24-29 for a listing of all V7-W accessories.
- ② Custom marking tags available. See page N38 for order form.
- ③ Catalog number is not complete. See pages N36...N37.

Isolation Blocks

| | | | |
|---|---------------------------------------|----------------------------------|----------------------------|
| Ordering and Technical Information ❶ | 4mm² | | |
| | | | |
| | Handle style isolating terminal block | | |
| | Catalog Number | Price Ea. (Std Pkg) | Pkg. Qty |
| Terminal - Black | V7-H7 | 8.15 | 25 |
| Accessories (also see pages N24...N29) | | | |
| End Barrier | V7-N37 | | 50 |
| End Anchors | | See, Accessory Pages for Pricing | |
| DIN Rail — Normal Duty | V7-EA35 | | 50 |
| DIN Rail — Heavy Duty | V7-EAH35 | | 10 |
| DIN Rail — Snap-in | V7-ER35 | | 50 |
| Jumpers | | | |
| Side Jumper - 10 pole Uninsulated | V7-N49 | | 10 |
| Side Jumper - Insulating Sleeve | V7-SJS | | 10 |
| Other Accessories | | | |
| Group Marking Carrier | V7-GM35 | | 10 |
| Marking Systems ❷ | | | |
| Blank Tags (cards of 100) | V7-SM8X12 | | 5 |
| Terminal Block Specifications | | | |
| Approvals | | | IEC |
| Voltage Rating | 300V AC/DC | 300V AC/DC | 500V AC/DC |
| Maximum Current | 15A | 15A | 15A |
| Wire Range (Rated Cross Section) | #30... 12 AWG | #30... 12 AWG | 0.5...4 mm ² |
| Wire Strip Length | 0.38" (9.7mm) | | |
| Recommended Tightening Torque | 3...7 lb-in. (0.3...0.8 Nm) | | |
| Density | 33 pcs./ft (109/m) | | |
| Insulation Temperature Range | -40°...+221°F (-40°...105°C) | | |
| Mounting Rail | Fits all types shown on page N30 | | |

❶ Refer to pages N24...N29 for a listing of all V7-W accessories.
 ❷ Custom marking tags available. See page N38 for order form.

Sensor Blocks

| Ordering and Technical Information ❶ | 2.5mm ² | | | 2.5mm ² | | | 2.5mm ² | | |
|---|----------------------------------|---------------------------------|---------------------------|---|---------------------------------|---------------------------|---|---------------------------------|---------------------------|
| | | | | | | | | | |
| | Three circuit terminal block | | | Three circuit terminal block with LED indicator for PNP devices | | | Three circuit terminal block with LED indicator for NPN devices | | |
| | Catalog Number | Price Ea. (Std Pkg) | Pkg. Qty | Catalog Number | Price Ea. (Std Pkg) | Pkg. Qty | Catalog Number | Price Ea. (Std Pkg) | Pkg. Qty |
| Terminal - Gray | V7-WTF3 | 5.29 | 50 | V7-WTF3LP ❶ | 10.95 | 50 | V7-WTF3LN ❶ | 10.95 | 50 |
| Accessories (also see pages N24...N29) | | | | | | | | | |
| End Barrier | V7-EBTF3 | | 50 | V7-EBTF3 | | 50 | V7-EBTF3 | | 50 |
| End Anchors | | | | | | | | | |
| DIN Rail — Normal Duty | V7-EA35 | | 50 | V7-EA35 | | 50 | V7-EA35 | | 50 |
| DIN Rail — Heavy Duty | V7-EAH35 | | 10 | V7-EAH35 | | 10 | V7-EAH35 | | 10 |
| DIN Rail — Snap-in | V7-ER35 | | 50 | V7-ER35 | | 50 | V7-ER35 | | 50 |
| Jumpers | | | | | | | | | |
| Side Jumper – 20-pole Insulated - Red | V7-SJT5-20-R | See Accessory Pages for Pricing | 10 | V7-SJT5-20-R | See Accessory Pages for Pricing | 10 | V7-SJT5-20-R | See Accessory Pages for Pricing | 10 |
| Side Jumper – 20-pole Insulated - Blue | V7-SJT5-20-B | | 10 | V7-SJT5-20-B | | 10 | V7-SJT5-20-B | | 10 |
| Center Jumper – 50-pole | V7-CJT5-50 | | 5 | V7-CJT5-50 | | 5 | V7-CJT5-50 | | 5 |
| Center Jumper – 10-pole | V7-CJT5-10 | | 10 | V7-CJT5-10 | | 10 | V7-CJT5-10 | | 10 |
| Center Jumper Link | V7-CJL5 | | 10 | V7-CJL5 | | 10 | V7-CJL5 | | 10 |
| Other Accessories | | | | | | | | | |
| Partition Plate | V7-PPTS3 | See Accessory Pages for Pricing | 50 | V7-PPTS3 | See Accessory Pages for Pricing | 50 | V7-PPTS3 | See Accessory Pages for Pricing | 50 |
| Test Plug Adaptor | V7-TA285 | | 10 | V7-TA285 | | 10 | V7-TA285 | | 10 |
| Electrical Warning Plate (1-pole) | V7-EWP5-4 | | 10 | V7-EWP5-4 | | 10 | V7-EWP5-4 | | 10 |
| Group Marking Carrier | V7-GM35 | | 10 | V7-GM35 | | 10 | V7-GM35 | | 10 |
| Marking Systems ❷ | | | | | | | | | |
| Blank Tags (cards of 100) ❸ | V7-SM5X9 | | 5 | V7-SM5X9 | | 5 | V7-SM5X9 | | 5 |
| Pre-printed Tags (sticks of 10) | V7-MP5 ❸ | | 10 | V7-MP5 ❸ | | 10 | V7-MP5 ❸ | | 10 |
| Terminal Block Specifications | | | | | | | | | |
| Approvals | UL | UL | IEC | UL | UL | IEC | UL | UL | IEC |
| Voltage Rating | 300V | 300V | 250V AC/DC | 300V AC/DC | 300V AC/DC | 250V AC/DC | 50V AC/DC | 50V AC/DC | 250V AC/DC |
| Maximum Current | 10 A | 10 A | 24 A | 10 A | 10 A | 24 A | 10 A | 10 A | 24 A |
| Wire Range (Rated Cross Section) | #26... #14 AWG | #26... #14 AWG | 0.5...2.5 mm ² | #26... #14 AWG | #26... #14 AWG | 0.5...2.5 mm ² | #26... #14 AWG | #26... #14 AWG | 0.5...2.5 mm ² |
| Leakage Current | | | | 2.69mA @ 50V | | | 2.69mA @ 50V | | |
| Wire Strip Length | 0.31" (8 mm) | | | 0.31" (8 mm) | | | 0.31" (8 mm) | | |
| Recommended Tightening Torque | 4.2...4.6 lb-in. (0.5 Nm) | | | 4.2...4.6 lb-in. (0.5 Nm) | | | 4.2...4.6 lb-in. (0.5 Nm) | | |
| Density | 60 pcs./ft (197/m) | | | 60 pcs./ft (197/m) | | | 60 pcs./ft (197/m) | | |
| Insulation Temperature Range | -40°...+195°F (-40°...+90°C) | | | -40°...+195°F (-40°...+90°C) | | | -40°...+195°F (-40°...+90°C) | | |
| Mounting Rail | Fits all types shown on page N30 | | | Fits all types shown on page N30 | | | Fits all types shown on page N30 | | |
| Wiring Diagram | See page N42 | | | | | | | | |
| | | | | | | | | | |

- ❶ May require special order with minimum quantities.
- ❷ Custom marking tags available. See page N38 for order form.
- ❸ Catalog number is not complete. See pages N36...N37.

Sensor Blocks

| Ordering and Technical Information ① | 2.5mm ² | | | 2.5mm ² | | | 2.5mm ² | | |
|---|----------------------------------|---------------------------------|------------------------------|---|---------------------------------|------------------------------|---|---------------------------------|------------------------------|
| | | | | | | | | | |
| | Three level sensor block | | | Three level sensor block LED indicator for PNP devices | | | Three level sensor block LED indicator for NPN devices | | |
| | Catalog Number | Price Ea. (Std Pkg) | Pkg. Qty | Catalog Number | Price Ea. (Std Pkg) | Pkg. Qty | Catalog Number | Price Ea. (Std Pkg) | Pkg. Qty |
| Terminal - Gray | V7-WTS3 | 5.09 | 50 | V7-WTS3LP ② | 10.69 | 50 | V7-WTS3LN ② | 10.69 | 50 |
| Accessories (also see pages N24...N29) | | | | | | | | | |
| End Barrier | V7-EBTS3 | | 50 | V7-EBTS3 | | 50 | V7-EBTS3 | | 50 |
| End Anchors | | | | | | | | | |
| DIN Rail — Normal Duty | V7-EA35 | | 50 | V7-EA35 | | 50 | V7-EA35 | | 50 |
| DIN Rail — Heavy Duty | V7-EAH35 | | 10 | V7-EAH35 | | 10 | V7-EAH35 | | 10 |
| DIN Rail — Snap-in | V7-ER35 | | 50 | V7-ER35 | | 50 | V7-ER35 | | 50 |
| Jumpers | | | | | | | | | |
| Side Jumper – 20-pole Insulated - Red | V7-SJT5-20-R | | 10 | V7-SJT5-20-R | | 10 | V7-SJT5-20-R | | 10 |
| Side Jumper – 20-pole Insulated - Blue | V7-SJT5-20-B | | 10 | V7-SJT5-20-B | | 10 | V7-SJT5-20-B | | 10 |
| Center Jumper – 50-pole | V7-CJT5-50 | | 5 | V7-CJT5-50 | | 5 | V7-CJT5-50 | | 5 |
| Center Jumper – 10-pole | V7-CJT5-10 | | 10 | V7-CJT5-10 | | 10 | V7-CJT5-10 | | 10 |
| Center Jumper Link | V7-CJL5 | | 10 | V7-CJL5 | | 10 | V7-CJL5 | | 10 |
| Other Accessories | | | | | | | | | |
| Partition Plate | V7-PPTS3 | See Accessory Pages for Pricing | 50 | V7-PPTS3 | See Accessory Pages for Pricing | 50 | V7-PPTS3 | See Accessory Pages for Pricing | 50 |
| Test Plug Adapter | V7-TA285 | | 10 | V7-TA285 | | 10 | V7-TA285 | | 10 |
| Electrical Warning Plate (1-pole) | V7-EWP5-4 | | 10 | V7-EWP5-4 | | 10 | V7-EWP5-4 | | 10 |
| Group Marking Carrier | V7-GM35 | | 10 | V7-GM35 | | 10 | V7-GM35 | | 10 |
| Marking Systems ② | | | | | | | | | |
| Blank Tags (cards of 100) ③ | V7-SM5X9 | | 5 | V7-SM5X9 | | 5 | V7-SM5X9 | | 5 |
| Pre-printed Tags (sticks of 10) | V7-MP5 ③ | | 10 | V7-MP5 ③ | | 10 | V7-MP5 ③ | | 10 |
| Terminal Block Specifications | | | | | | | | | |
| Approvals | UL | UL | IEC | UL | UL | IEC | UL | UL | IEC |
| Voltage Rating | 300V | 300V | 250V AC/DC | 300V AC/DC | 300V AC/DC | 250V AC/DC | 300V AC/DC | 300V AC/DC | 250V AC/DC |
| Maximum Current | 10 A | 10 A | 24 A | 10 A | 10 A | 24 A | 10 A | 10 A | 24 A |
| Wire Range (Rated Cross Section) | #26... #14 AWG | #26... #14 AWG | 0.5...2.5 mm ² | #26... #14 AWG | #26... #14 AWG | 0.5...2.5 mm ² | #26... #14 AWG | #26... #14 AWG | 0.5...2.5 mm ² |
| Leakage Current | 0.31" (8 mm) | | | 2.69mA @ 50V | | | 2.69mA @ 50V | | |
| Wire Strip Length | 0.31" (8 mm) | | | 0.31" (8 mm) | | | 0.31" (8 mm) | | |
| Recommended Tightening Torque | 4.2...4.6 lb-in. (0.5 Nm) | | | 4.2...4.6 lb-in. (0.5 Nm) | | | 4.2...4.6 lb-in. (0.5 Nm) | | |
| Density | 60 pcs./ft (197/m) | | | 60 pcs./ft (197/m) | | | 60 pcs./ft (197/m) | | |
| Insulation Temperature Range | -40°...+195°F (-40°...+90°C) | | | -40°...+195°F (-40°...+90°C) | | | -40°...+195°F (-40°...+90°C) | | |
| Mounting Rail | Fits all types shown on page N30 | | | Fits all types shown on page N30 | | | Fits all types shown on page N30 | | |
| Wiring Diagram | See page N42 | | | | | | | | |

- ① May require special order with minimum quantities.
- ② Custom marking tags available. See page N38 for order form.
- ③ Catalog number is not complete. See pages N36...N37.

N
V7 Terminals

Plug-in Style Blocks

| Ordering and Technical Information ① | 2.5mm ² | | | 2.5mm ² | | |
|---|----------------------------------|---------------------------------|------------------------------|--|---------------------------------|------------------------------|
| | | | | | | |
| | Pluggable terminal block | | | Pluggable terminal block with test plug screws | | |
| | Catalog Number | Price Ea. (Std Pkg) | Pkg. Qty | Catalog Number | Price Ea. (Std Pkg) | Pkg. Qty |
| Terminal - Gray | V7-W4P | 2.83 | 50 | V7-W4PTP | 3.74 | 50 |
| Accessories (also see pages N24...N29) | | | | | | |
| Inserts | | | | | | |
| Disconnect Plug | V7-DP4 | See Accessory Pages for Pricing | 50 | V7-DP4 (shown) | See Accessory Pages for Pricing | 50 |
| Component Plug | V7-CP4 ④⑤ | | 50 | V7-CP4 ④ | | 50 |
| Fuse Plug | V7-FP4 ⑥ (shown) | | 50 | V7-FP4 ④⑤ | | 50 |
| Fuse Plug w/LED Blown Fuse Indication | V7-FP424 ④⑤ | | 50 | V7-FP424 ④⑤ | | 50 |
| Fuse Plug w/LED Blown Fuse Indication | V7-FP4250 ④⑤ | | 50 | V7-FP4250 ④⑤ | | 50 |
| End Barrier | V7-EB3 | | | 50 | | V7-EB3 |
| End Anchors | | | | | | |
| DIN Rail — Normal Duty | V7-EA35 | See Accessory Pages for Pricing | 50 | V7-EA35 | See Accessory Pages for Pricing | 50 |
| DIN Rail — Heavy Duty | V7-EAH35 | | 10 | V7-EAH35 | | 10 |
| DIN Rail — Snap-in | V7-ER35 | | 50 | V7-ER35 | | 50 |
| Jumpers | | | | | | |
| Side Jumper — 10-pole Insulated | V7-SJ6-10 | | 10 | V7-SJ6-10 | | 10 |
| Other Accessories | | | | | | |
| Partition Plate | V7-PP3 | | 50 | V7-PP3 | | 50 |
| Test Plug | | | | V7-TP23 | | 50 |
| Group Marking Carrier | V7-GM35 | | 10 | V7-GM35 | | 10 |
| Marking Systems ⑥ | | | | | | |
| Blank Tags (cards of 100) | V7-SM6X12 | | 5 | V7-SM6X12 | | 5 |
| Pre-printed Tags (sticks of 10) | V7-MP ⑦ | | 10 | V7-MP ⑦ | | 10 |
| Terminal Block Specifications | | | | | | |
| Approvals | UL | UL | IEC | UL | UL | IEC |
| Voltage Rating | 600V AC/DC | 600V AC/DC | 800V AC/DC | 600V AC/DC | 600V AC/DC | 800V AC/DC |
| Maximum Current | 20 A | 20 A | 32 A | 20 A | 20 A | 32 A |
| Wire Range (Rated Cross Section) | #22... #12 AWG | #22... #12 AWG | 0.5...2.5 mm ² | #22... #12 AWG | #22... #12 AWG | 0.5...2.5 mm ² |
| Wire Strip Length | 0.35" (9mm) | | | 0.35" (9mm) | | |
| Recommended Tightening Torque | 5.0...5.6 lb-in. (0.6 Nm) | | | 5.0...5.6 lb-in. (0.6 Nm) | | |
| Density | 50 pcs./ft (166/m) | | | 50 pcs./ft (166/m) | | |
| Insulation Temperature Range | -40°...+195°F (-40°...+90°C) | | | -40°...+195°F (-40°...+90°C) | | |
| Mounting Rail | Fits all types shown on page N30 | | | Fits all types shown on page N30 | | |

① Refer to pages N24...N29 for a listing of all V7-W accessories.
 ② Overall height varies with plug-in component. For V7-DP4, use 2.5" (63.5 mm); for V7-CP4, use 2.9" (74 mm); and for V7-FP4..., use 3.1" (78 mm).
 ③ Maximum current and voltage rating of component plug is 0.5W @ 250V maximum current rating for the base terminal block is listed under Specifications.

④ Maximum current and voltage ratings for the fuse plug are 10A and 250V. Maximum ratings for the base blocks are listed under Specifications.
 ⑤ See page N42 for Fuse Plug Specifications.
 ⑥ Custom marking tags available. See page N38 for order form.
 ⑦ Catalog number is not complete. See pages N36...N37.

Multi-level Plug-in Style Blocks

| Ordering and Technical Information ① | 2.5mm ² | | | 2.5mm ² | | |
|---|---|---------------------|---------------------------|---|---------------------|---------------------------|
| | | | | | | |
| | Two level terminal block with top level capable of accepting plug-in components and lower level acting as an independent feed-through circuit | | | Three level terminal block with top level capable of accepting plug-in components second level acting as an independent feed-through circuit, and third level acting as a grounding circuit | | |
| | Catalog Number | Price Ea. (Std Pkg) | Pkg. Qty | Catalog Number | Price Ea. (Std Pkg) | Pkg. Qty |
| Terminal - Gray | V7-WD4P | 5.60 | 50 | V7-WDG4P | 7.56 | 50 |
| Accessories (also see pages N24...N29) | | | | | | |
| Inserts | | | | | | |
| Disconnect Plug | V7-DP4 (shown) | | 50 | V7-DP4 (shown) | | 50 |
| Component Plug | V7-CP4 ② | | 50 | V7-CP4 ② | | 50 |
| Fuse Plug | V7-FP4 ③④ | | 50 | V7-FP4 ③④ | | 50 |
| Fuse Plug w/LED Blown Fuse Indication | V7-FP424 ③④ | | 50 | V7-FP424 ③④ | | 50 |
| Fuse Plug w/LED Blown Fuse Indication | V7-FP4250 ③④ | | 50 | V7-FP4250 ③④ | | 50 |
| End Barrier | V7-EBD4P | | 50 | V7-EBD4P | | 50 |
| End Anchors | | | | | | |
| DIN Rail — Normal Duty | V7-EA35 | | 50 | V7-EA35 | | 50 |
| DIN Rail — Heavy Duty | V7-EAH35 | | 10 | V7-EAH35 | | 10 |
| DIN Rail — Snap-in | V7-ER35 | | 50 | V7-ER35 | | 50 |
| Jumpers | | | | | | |
| Side Jumper – 10-pole Insulated | V7-SJ6-10 | | 10 | V7-SJ6-10 | | 10 |
| Center Jumper – 50-pole | V7-CJD6-50 | | 5 | V7-CJD6-10 | | 10 |
| Center Jumper – 10-pole | V7-CJD6-10 | | 10 | V7-CJD6-3 | | 10 |
| Center Jumper – 3-pole | V7-CJD6-3 | | 10 | V7-CJD6-2 | | 10 |
| Center Jumper – 2-pole | V7-CJD6-2 | | 10 | V7-CJDL6 | | 10 |
| Center Jumper Link | V7-CJDL6 | | 10 | | | |
| Other Accessories | | | | | | |
| Test Plug | V7-TP28 | | 10 | V7-TP28 | | 10 |
| Test Plug Adapter | V7-TA40 | | 10 | V7-TA40 | | 10 |
| Group Marking Carrier | V7-GM35 | | 10 | V7-GM35 | | 10 |
| Marking Systems ⑤ | | | | | | |
| Blank Tags (cards of 100) | V7-SM6X9 | | 5 | V7-SM6X9 | | 5 |
| Pre-printed Tags (sticks of 10) | V7-MP ⑥ | | 10 | V7-MP ⑥ | | 10 |
| Terminal Block Specifications | | | | | | |
| Approvals | UL | UL | IEC | UL | UL | IEC |
| Voltage Rating | 300V AC/DC | 300V AC/DC | 500V AC/DC | 300V AC/DC | 300V AC/DC | 500V AC/DC |
| Maximum Current | 15 A | 15 A | 20 A | 15 A | 15 A | 20 A |
| Wire Range (Rated Cross Section) | #22... #12 AWG | #22... #12 AWG | 0.5...2.5 mm ² | #22... #12 AWG | #22... #12 AWG | 0.5...2.5 mm ² |
| Wire Strip Length | 0.31" (8mm) | | | 0.31" (8mm) | | |
| Recommended Tightening Torque | 5.0...5.6 lb-in. (0.6 Nm) | | | 5.0...5.6 lb-in. (0.6 Nm) | | |
| Density | 50 pcs./ft (166/m) | | | 50 pcs./ft (166/m) | | |
| Insulation Temperature Range | -40°...+195°F (-40°...+90°C) | | | -40°...+195°F (-40°...+90°C) | | |
| Mounting Rail | Fits all types shown on page N30 | | | Fits all types shown on page N30 | | |

- ① Refer to pages N24...N29 for a listing of all V7-W accessories.
- ② Overall height varies with plug-in component. For V7-DP4, use 2.5" (63.5 mm); for V7-CP4, use 2.9" (74 mm); and for V7-FP4..., use 3.1" (78 mm).
- ③ Maximum current and voltage rating of component plug is 1A @ 600V. Maximum current rating for the base terminal block is listed under Specifications.

- ④ Maximum current and voltage ratings for the fuse plug are 10A and 250V. Maximum ratings for the base blocks are listed under Specifications.
- ⑤ See page N42 for Fuse Plug Specifications.
- ⑥ Custom marking tags available. See page N38 for order form.
- ⑦ Catalog number is not complete. See pages N36...N37.

Component Blocks

| Ordering and Technical Information | 4mm ² | | | 4mm ² | | | 4mm ² | | |
|--|---|---------------------------------|--------------------------|---|---------------------------------|--------------------------|---|---------------------------------|--------------------------|
| | | | | | | | | | |
| | Two level block with a commoning bar between the upper and lower levels, providing multiple outlets | | | Two level block with a diode in forward bias between the upper and lower levels | | | Two level block with a diode in reverse bias between the upper and lower levels | | |
| | Catalog Number | Price Ea. (Std Pkg) | Pkg. Qty | Catalog Number | Price Ea. (Std Pkg) | Pkg. Qty | Catalog Number | Price Ea. (Std Pkg) | Pkg. Qty |
| Terminal - Gray | V7-WD4C | 5.61 | 50 | V7-WD4DF | 6.95 | 1 | V7-WD4DR | 6.95 | 1 |
| Accessories (also see pages N24 - N29) | | | | | | | | | |
| End Barrier | V7-EBD3 | | 50 | V7-EBD3 | | 50 | V7-EBD3 | | 50 |
| End Anchors | | | | | | | | | |
| DIN Rail — Normal Duty | V7-EA35 | | 50 | V7-EA35 | | 50 | V7-EA35 | | 50 |
| DIN Rail — Heavy Duty | V7-EAH35 | | 10 | V7-EAH35 | | 10 | V7-EAH35 | | 10 |
| DIN Rail — Snap-in | V7-ER35 | | 50 | V7-ER35 | | 50 | V7-ER35 | | 50 |
| Jumpers | | | | | | | | | |
| Side Jumper – 10-pole Insulated | V7-SJ6-10 | See Accessory Pages for Pricing | 10 | V7-SJ6-10 | See Accessory Pages for Pricing | 10 | V7-SJ6-10 | See Accessory Pages for Pricing | 10 |
| Center Jumper – 50-pole | V7-CJD6-50 | | 5 | V7-CJD6-50 | | 5 | V7-CJD6-50 | | 5 |
| Center Jumper – 10-pole | V7-CJD6-10 | | 10 | V7-CJD6-10 | | 10 | V7-CJD6-10 | | 10 |
| Center Jumper – 3-pole | V7-CJD6-3 | | 10 | V7-CJD6-3 | | 10 | V7-CJD6-3 | | 10 |
| Center Jumper – 2-pole | V7-CJD6-2 | | 10 | V7-CJD6-2 | | 10 | V7-CJD6-2 | | 10 |
| Center Jumper Link | V7-CJDL6 | | 10 | V7-CJDL6 | | 10 | V7-CJDL6 | | 10 |
| Other Accessories | | | | | | | | | |
| Partition Plate | V7-PPD3 | | 50 | V7-PPD3 | | 50 | V7-PPD3 | | 50 |
| Separation Plate | V7-SPD3 | | 10 | V7-SPD3 | | | V7-SPD3 | | 10 |
| Test Plug | V7-TP28 | | 10 | V7-TP28 | | 10 | V7-TP28 | | 10 |
| Test Plug Adapter | V7-TA40 | | 10 | V7-TA40 | | 10 | V7-TA40 | | 10 |
| Group Marking Carrier | V7-GM35 | | 10 | V7-GM35 | | 10 | V7-GM35 | | 10 |
| Marking Systems | | | | | | | | | |
| Blank Tags (cards of 100) | V7-SM6X9 | | 5 | V7-SM6X9 | | 5 | V7-SM6X9 | | 5 |
| Pre-printed Tags (sticks of 10) | V7-MP | | 10 | V7-MP | | 10 | V7-MP | | 10 |
| Terminal Block Specifications | | | | | | | | | |
| Approvals | | | IEC | | | IEC | | | IEC |
| Voltage Rating | 300V AC/DC | 300V AC/DC | 500V AC/DC | 300V AC/DC | 300V AC/DC | 500V AC/DC | 300V AC/DC | 300V AC/DC | 500V AC/DC |
| Maximum Current | 20 A | 20 A | 32 A | 1 A (Diode) | 1 A (Diode) | 1 A (Diode) | 1 A (Diode) | 1 A (Diode) | 1 A (Diode) |
| Wire Range (Rated Cross Section) | #22... #12 AWG | #22... #12 AWG | 0.05...4 mm ² | #22... #12 AWG | #22... #12 AWG | 0.05...4 mm ² | #22... #12 AWG | #22... #12 AWG | 0.05...4 mm ² |
| Working Voltage | | | | Diode 1N4007 | | | Diode 1N4007 | | |
| Wire Strip Length | 0.39" (10mm) | | | 0.39" (10mm) | | | 0.39" (10mm) | | |
| Recommended Tightening Torque | 5.0...5.6 lb-in. (0.6 Nm) | | | 5.0...5.6 lb-in. (0.6 Nm) | | | 5.0...5.6 lb-in. (0.6 Nm) | | |
| Density | 50 pcs./ft (166/m) | | | 50 pcs./ft (166/m) | | | 50 pcs./ft (166/m) | | |
| Insulation Temperature Range | -40°...+195°F (-40°...+90°C) | | | -40°...+195°F (-40°...+90°C) | | | -40°...+195°F (-40°...+90°C) | | |
| Mounting Rail | Fits all types shown on page N30 | | | Fits all types shown on page N30 | | | Fits all types shown on page N30 | | |
| Schematics | | | | | | | | | |
| Diode Block | | | | | | | | | |
| Uses a 1N4007 diode between the upper and lower levels for insertion into a control circuit. This block is useful in low voltage DC control circuits for directioning and suppression. | | | | | | | | | |

① May require special order with minimum quantities.
 ② Custom marking tags available. See page N38 for order form.





③ Catalog number is not complete. See pages N36...N37.
 ④ See page N41 for Component Specifications.

Thermocouple Blocks ①

| | | | | |
|---|-----------------------------|---|---------------------------------|---------------------|
| Ordering and Technical Information ① | 2.5mm² | | | |
| | | | | |
| | Two-pole thermocouple block | | | |
| | | Catalog Number | Price Ea. (Std Pkg) | Pkg. Qty |
| Current Bar Material | | | | |
| Pos. Leg / Neg. Leg | Trade Name | | | |
| NiCr / CuNi | Chromel / Constantan | V7-WTC3E | 8.96 | 10 |
| Ir / CuNi | Iron / Constantan | V7-WTC3J | 8.96 | 10 |
| Cu / CuNi | Copper / Constantan | V7-WTC3T | 8.96 | 10 |
| Accessories (also see pages N24 - N29) | | | | |
| End Barrier | | V7-EB3 | | 50 |
| End Anchors | | | | |
| DIN Rail — Normal Duty | | V7-EA35 | See Accessory Pages for Pricing | 50 |
| DIN Rail — Heavy Duty | | V7-EAH35 | | 10 |
| DIN Rail — Snap-in | | V7-ER35 | | 50 |
| Other Accessories | | | | |
| Partition Plate | | V7-PP3 | | |
| Group Marking Carrier | | V7-GM35 | | 10 |
| Marking Systems ② | | | | |
| Blank Tags (cards of 100) ③ | | V7-SM5X9 | | 5 |
| Pre-printed Tags (sticks of 10) | | V7-MP5 ③ | | 10 |
| Terminal Block Specifications | | | | |
| Approvals | | | | |
| Wire Range (Rated Cross Section) | | 0.28...#14 AWG 0.2...2.5 mm ² | | |
| Wire Strip Length | | 0.35" (10mm) | | |
| Recommended Tightening Torque | | 5.0...5.6 lb-in. (0.6 Nm) | | |
| Density | | 30 pcs./ft (100/m) | | |
| Insulation Temperature Range | | -40°...+195°F (-40°...105°C) | | |
| Mounting Rail | | Fits all types shown on page N30 | | |

- ① May require special order with minimum quantities.
- ② Custom marking tags available. See page N38 for order form.
- ③ Catalog number is not complete. See pages N36...N37.

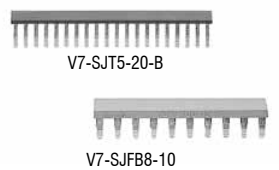
Accessories





| Component | Description | Type | Catalog Number | Price Each | Std. Pkg. | pg. N5 | pg. N5 | pg. N5 | pg. N6 | pg. N6 |
|---|---|------------------|----------------|------------|-----------|-------------|-------------|-------------|--------------|---------------|
| | | | | | | -W3 Through | -W4 Through | -W6 Through | -W10 Through | -W16S Through |
|  <p>V7-EB3 V7-EB35</p> <p>V7-N37</p> | End Barrier Provides insulation for the last terminal block in a group. Gray unless noted. | | V7-EB10 | 0.64 | 50 | | | | | |
| | | (shown) | V7-EB3 | 0.64 | 50 | ■ | ■ | | | |
| | | | V7-EB3TW | 0.72 | 50 | | | | | |
| | | (shown) | V7-EB35 | 1.21 | 25 | | | | | |
| | | | V7-EBD3 | 1.04 | 50 | | | | | |
| | | yellow | V7-EBD3-Y | 1.04 | 50 | | | | | |
| | | | V7-EBD6 | 1.21 | 50 | | | | | |
| | | | V7-EBD4P | 1.12 | 50 | | | | | |
| | | | V7-EBKD3 | 0.64 | 50 | | | | | |
| | | | V7-EBR3 | 0.72 | 50 | | | | | |
| | | | V7-EBTF3 | 1.04 | 50 | | | | | |
| | | (shown) | V7-EBTS3 | 1.04 | 50 | | | | | |
| | | | V7-N37 | 0.80 | 50 | | | | | |
| yellow | V7-EB10-Y | 0.80 | 50 | | | | | | | |
| yellow | V7-EB3-Y | 0.64 | 50 | | | | | | | |
| | V7-EBFB10V | 1.04 | 50 | | | | | | | |
|  <p>V7-EA35 V7-ER35</p> | End Anchor (Screw type) Anchors a row of blocks or a single block | Standard (shown) | V7-EA35 | 0.93 | 50 | ■ | ■ | ■ | ■ | ■ |
| | | Heavy Duty | V7-EAH35 | 3.74 | 10 | ■ | ■ | ■ | ■ | ■ |
| | | Snap In (shown) | V7-ER35 | 1.01 | 50 | ■ | ■ | ■ | ■ | ■ |
|  <p>V7-SJT5-20-B</p> <p>V7-SJFB8-10</p> | Side Jumpers Insulated, fit in wire openings of blocks | | V7-SJ5-10 | 1.93 | 10 | ■ | | | | |
| | | | V7-SJ6-10 | 2.37 | 10 | | ■ | | | |
| | | | V7-SJ8-10 | 2.73 | 10 | | | | ■ | |
| | | (shown) | V7-SJFB8-10 | 4.49 | 10 | | | | | |
| | | Blue | V7-SJT5-20-B | 5.88 | 10 | | | | | |
| Red | V7-SJT5-20-R | 5.61 | 10 | | | | | | | |
| | Non-insulated | V7-N49 | 3.26 | 10 | | | | | | |
|  <p>V7-SJS</p> | Insulating Side Jumper Sleeve For use with catalog # V7-N49 | | V7-SJS | 1.44 | 10 | | | | | |
| | | | V7-FCM | 2.81 | 50 | | | | | |
|  <p>V7-CJ5-10</p> | Center Jumpers Uninsulated, screw into threaded hole in center of block (See page N28 for more Center Jumpers) | 2 pole | V7-CJ5-2 | 1.21 | 10 | ■ | | | | |
| | | 3 pole | V7-CJ5-3 | 1.76 | 10 | ■ | | | | |
| | | 10 pole | V7-CJ5-10 | 4.76 | 10 | ■ | | | | |
| | | 50 pole | V7-CJ5-50 | 22.44 | 5 | ■ | | | | |
| | | 2 pole | V7-CJ6-2 | 1.28 | 10 | | ■ | | | |
| | | 3 pole | V7-CJ6-3 | 1.87 | 10 | | ■ | | | |
| 10 pole | V7-CJ6-10 | 5.02 | 10 | | ■ | | | | | |
| 50 pole | V7-CJ6-50 | 19.78 | 5 | | ■ | | | | | |

Note: For full line of marking accessories see the Marking Section beginning on page N35.

| -W35 Through | pg. N7 |
|-------------------------------|------------|
| -W70 Through | pg. N7 |
| -WDG4C Two Level Ground | pg. N12 |
| -WG4 Ground | pg. N10 |
| -WG6 Ground | pg. N10 |
| -WG10S Ground | pg. N10 |
| -WG16, -W35, -W70 Ground | pg. N11 |
| -WD3 Two Level | pg. N8 |
| -WD4 Two Level | pg. N8 |
| -WD6 Two Level | pg. N8 |
| -W3TW 2 in / 1 out | pg. N9 |
| -WR3 Return | pg. N9 |
| -WKD3 Knife Disconnect | pg. N16 |
| -WKD3TP Knife Disconnect | pg. N16 |
| -WKD6 Knife Disconnect | pg. N16 |
| -W4P Pluggable | pg. N20 |
| -W4PTP Pluggable | pg. N20 |
| -WD4P Pluggable 2 level | pg. N21 |
| -WDG4P Pluggable 2 Level | pg. N21 |
| -WD4C/DF/DR 2 level | pg. N22 |
| -WFB4/424/4250 Fuse Pluggable | pg. N13 |
| -H4/5/6/7 Fusible | pg. N14&17 |
| -WFB10V/VA | pg. N15 |
| -WTC3E/J/T Thermocouple | pg. N23 |
| -WTF3/LP/LN Sensor | pg. N18 |
| -WTS3/LP/LN Sensor | pg. N19 |

Continued on next page ➡







Accessories (Continued)

| Component | Description | Type | Catalog Number | Price Each | Std. Pkg. | pg. N5 | pg. N5 | pg. N5 | pg. N6 | pg. N6 |
|---|--|---------|----------------|------------|-----------|-------------|-------------|-------------|--------------|---------------|
| | | | | | | -W3 Through | -W4 Through | -W6 Through | -W10 Through | -W16S Through |
|  | Center Jumpers Uninsulated, screw into threaded hole in center of block | 2 pole | V7-CJ7-2 | 1.55 | 10 | | | ■ | | |
| | | 3 pole | V7-CJ7-3 | 2.19 | 10 | | | ■ | | |
| | | 10 pole | V7-CJ7-10 | 5.88 | 10 | | | ■ | | |
| | | 40 pole | V7-CJ7-40 | 19.78 | 5 | | | ■ | | |
| | | 2 pole | V7-CJ8-2 | 1.65 | 10 | | | | ■ | |
| | | 3 pole | V7-CJ8-3 | 2.19 | 10 | | | | ■ | |
| | | 10 pole | V7-CJ8-10 | 6.55 | 10 | | | | ■ | |
| | | 40 pole | V7-CJ8-40 | 22.44 | 5 | | | | ■ | |
| | | 2 pole | V7-CJS11-2 | 2.83 | 10 | | | | | ■ |
| | | 3 pole | V7-CJS11-3 | 3.79 | 10 | | | | | ■ |
| | | 10 pole | V7-CJS11-10 | 18.71 | 10 | | | | | ■ |
| | | 2 pole | V7-CJ14-2 | 3.10 | 10 | | | | | |
| | | 3 pole | V7-CJ14-3 | 4.65 | 10 | | | | | |
| | | 2 pole | V7-CJD5-2 | 1.39 | 10 | | | | | |
| | | 3 pole | V7-CJD5-3 | 2.03 | 10 | | | | | |
| | | 10 pole | V7-CJD5-10 | 5.34 | 10 | | | | | |
| | | 50 pole | V7-CJD5-50 | 22.44 | 5 | | | | | |
| | | 2 pole | V7-CJD6-2 | 1.28 | 10 | | | | | |
| 3 pole | V7-CJD6-3 | 1.87 | 10 | | | | | | | |
| 10 pole | V7-CJD6-10 | 5.02 | 10 | | | | | | | |
| 50 pole | V7-CJD6-50 | 19.78 | 5 | | | | | | | |
| 10 pole | V7-CJT5-10 | 5.34 | 10 | | | | | | | |
| 50 pole | V7-CJT5-50 | 22.44 | 10 | | | | | | | |
|  | Center Jumper Links Joins two Center Jumpers | | V7-CJL5 | 0.72 | 10 | ■ | | | | |
| | | | V7-CJL6 | 0.72 | 10 | | ■ | | | |
| | | | V7-CJL7 | 0.72 | 10 | | | ■ | | |
| | | | V7-CJL8 | 0.72 | 10 | | | | ■ | |
| | | | V7-CJDL6 | 0.72 | 10 | | | | | ■ |
|  <p>V7-CJCW5</p> | Center Jumper Covers | | V7-CJCW5 | 2.83 | 20 | ■ | | | | |
| | | | V7-CJCW6 | 2.83 | 20 | | ■ | ■ | ■ | |
| | | | V7-CJCW14 | 2.97 | 10 | | | | | |
|  | Screwdriver - Specially designed for the screws on V7-W3, W4 & W6 terminals | | V7-SCRDRV1 | 8.81 | 1 | ■ | ■ | ■ | | |

Note: For full line of marking accessories see the Marking Section beginning on page N35.

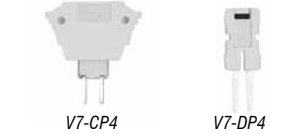
| -W35 Through | pg. N7 |
|-------------------------------|------------|
| -W70 Through | pg. N7 |
| -WDG4C Two Level Ground | pg. N12 |
| -WG4 Ground | pg. N10 |
| -WG6 Ground | pg. N10 |
| -WG10S Ground | pg. N10 |
| -WG16, -W35, -W70 Ground | pg. N11 |
| -WD3 Two Level | pg. N8 |
| -WD4 Two Level | pg. N8 |
| -WD6 Two Level | pg. N8 |
| -W3TW 2 in / 1 out | pg. N9 |
| -WR3 Return | pg. N9 |
| -WKD3 Knife Disconnect | pg. N16 |
| -WKD3TP Knife Disconnect | pg. N16 |
| -WKD6 Knife Disconnect | pg. N16 |
| -W4P Pluggable | pg. N20 |
| -W4PTP Pluggable | pg. N20 |
| -WD4P Pluggable 2 level | pg. N21 |
| -WDG4P Pluggable 2 Level | pg. N21 |
| -WD4C/DF/DR 2 level | pg. N22 |
| -WFB4/424/4250 Fuse Pluggable | pg. N13 |
| -H4/5/6/7 Fusible | pg. N14&17 |
| -WFB10V/VA | pg. N15 |
| -WTC3E/J/T Thermocouple | pg. N23 |
| -WTF3/LP/LN Sensor | pg. N18 |
| -WTS3/LP/LN Sensor | pg. N19 |

Accessories (Continued)

| Component | Description | Type | Catalog Number | Price Each | Std. Pkg. | pg. N5 | pg. N5 | pg. N5 | pg. N6 | pg. N6 |
|--|---|-----------------|----------------|------------|-----------|-------------|-------------|-------------|--------------|---------------|
| | | | | | | -W3 Through | -W4 Through | -W6 Through | -W10 Through | -W16S Through |
|  <p>V7-PP35 V7-PPD3</p> | Partition Plates Provides visual and electrical spacing between adjacent jumpers | | V7-PP10 | 0.96 | 50 | | | | | |
| | | | V7-PP3 | 0.80 | 50 | ■ | ■ | | | |
| | | (shown) | V7-PP35 | 1.34 | 25 | | | | | |
| | | (shown) | V7-PPD3 | 1.21 | 50 | | | | | |
| | | | V7-PPD6 | 1.21 | 50 | | | | | |
| | | Mini | V7-PPSL3 | 1.04 | 50 | | | | | |
| | | Mini | V7-PPTS3 | 0.67 | 50 | | | | | |
|  <p>V7-SP3 V7-SPD3</p> | Separation Plate Thin, flexible plastic insulation plate provides visual and electrical isolation between adjacent center jumpers | (shown) | V7-SP3 | 0.48 | 50 | ■ | ■ | | | |
| | | (shown) | V7-SPD3 | 0.48 | 50 | | | | | |
|  | Electrical Warning Plates | | V7-EWP5-4 | 1.21 | 10 | ■ | | | | |
| | | | V7-EWP6-4 | 1.21 | 10 | | ■ | | | |
| | | | V7-EWP7-4 | 1.21 | 10 | | | ■ | | |
| | | | V7-EWP8-4 | 1.60 | 10 | | | | ■ | |
|  <p>V7-CP4 V7-DP4</p> | Component Plugs Holds customer supplied diode or resistor Disconnect Plug No load isolator | | V7-CP4 | 3.96 | 50 | | | | | |
| | | | V7-DP4 | 1.44 | 50 | | | | | |
|  | Fuse Plugs Holds 5x20 fuse | W/O BFI | V7-FP4 | 5.88 | 50 | | | | | |
| | | W/ 24V BFI LED | V7-FP424 | 11.75 | 50 | | | | | |
| | | W/ 240V BFI LED | V7-FP4250 | 11.75 | 50 | | | | | |
|  <p>V7-TP15 V7-TP6E V7-TP6EWL</p> | Test Plugs Wire is soldered directly to plug | (shown) | V7-TP15 | 9.48 | 10 | | | | | |
| | | | V7-TP23 | 4.76 | 10 | | | | | |
| | | | V7-TP28 | 4.76 | 10 | | ■ | ■ | ■ | |
| | | (shown) | V7-TP6E | 6.95 | 10 | | ■ | | | |
| | | (shown) | V7-TP6EWL | 6.95 | 10 | | ■ | | | |
|  <p>V7-TA40 V7-TA285</p> | Test Plugs Adapters Accepts Banana Plug | (shown) | V7-TA285 | 9.48 | 10 | ■ | | | | |
| | | | V7-TA40 | 9.48 | 10 | | ■ | ■ | ■ | |
|  | Group Marker Carrier Used for separating and identifying groups of terminals, snap-on, markable | | V7-GM35 | 1.93 | 10 | ■ | ■ | ■ | ■ | ■ |

Note: For full line of marking accessories see the Marking Section beginning on page N35.

Mounting Rails

| Item | Description | Catalog Number | Price |
|---|---|----------------|----------------|
|  | DIN-rail - 2 meter lengths (≈6' 6") • Top Hat, low profile (price per rail) • Top Hat, high profile (price per rail) | 3F 3AF | 42.04 27.71 |

Multiple Wire Connection Combinations - Stranded Copper Conductors of the Same Cross-section

| Catalog Number | Wire Size AWG (mm ²) | | | | | | | | | | | | | | | | |
|---------------------------|--|---------------|--------------|--------------|------------|------------|-------------|------------|------------|------------|------------|-------------|-------------|-------------|-----------------|-----------------|--|
| | #22 (0.5) | #20 (0.75) | #18 (1.5) | #16 (2.5) | #14 (4) | #12 (6) | #10 (10) | #8 (16) | #6 (25) | #4 (35) | #2 (40) | 1/0 (50) | 2/0 (70) | 3/0 (80) | 300MCM (150) | 500MCM (250) | |
| | Number of same size wires per panel | | | | | | | | | | | | | | | | |
| V7-H4,-H5,-H6,-H7 | 4 | 4 | 3 | 2 | 2 | 1 | | | | | | | | | | | |
| V7-W4 | 4 | 4 | 3 | 2 | 2 | 1 | 1 | | | | | | | | | | |
| V7-W4P | 4 | 4 | 3 | 2 | 2 | 1 | Ⓢ | | | | | | | | | | |
| V7-W4PTP | 4 | 4 | 3 | 2 | 2 | 1 | Ⓢ | | | | | | | | | | |
| V7-W6 | 4 | 4 | 3 | 2 | 2 | 1 | 1 | | | | | | | | | | |
| V7-W10 | 4 | 4 | 4 | 4 | 3 | 2 | 1 | 1 | | | | | | | | | |
| V7-W16S | | | | | 4 | 3 | 2 | 2 | 1 | 1 | | | | | | | |
| V7-W35 ① | | | | | 3 | 3 | 3 | 2 | 2 | 1 | 1 | 1 | 1 | | | | |
| V7-W70 ① | | | | | 5 | 5 | 5 | 2 | 2 | 2 | 2 | 1 | 1 | 1 | 1 | | |
| V7-WD6 ① | | | 3 | 2 | 2 | 1 | 1 | | | | | | | | | | |
| V7-WD4DF | 4 | 4 | 3 | 2 | 2 | 1 | | | | | | | | | | | |
| V7-WD4DR | 4 | 4 | 3 | 2 | 2 | 1 | | | | | | | | | | | |
| V7-WD4P | 4 | 4 | 3 | 2 | 2 | 1 | Ⓢ | | | | | | | | | | |
| V7-WD4PTP | 4 | 4 | 3 | 2 | 2 | 1 | Ⓢ | | | | | | | | | | |
| V7-WDG4C | 4 | 4 | 3 | 2 | 2 | 1 | | | | | | | | | | | |
| V7-WDG4P... | 4 | 4 | 3 | 2 | 2 | 1 | Ⓢ | | | | | | | | | | |
| V7-WFB10V(A) | | | | | | | | 1 | | | | | | | | | |
| V7-WFB4 | 4 | 4 | 3 | 2 | 2 | 1 | | | | | | | | | | | |
| V7-WG4 | 4 | 4 | 3 | 2 | 1 | 1 | | | | | | | | | | | |
| V7-WG6 | 4 | 4 | 3 | 2 | 2 | 1 | 1 | 1 | | | | | | | | | |
| V7-WG10S ① | 4 | 4 | 4 | 4 | 3 | 2 | 1 | 1 | | | | | | | | | |
| V7-WG16 ① | | | | | | 2 | 1 | 1 | 1 | | | | | | | | |
| V7-WG35 ① | | | | | | | | 2 | 1 | 1 | 1 | 1 | 1 | | | | |
| V7-WG70 | | | | | | | | | 2 | 1 | 1 | 1 | 1 | | | | |
| V7-WKD3TP | 4 | 4 | 3 | 2 | 1 | | | | | | | | | | | | |
| V7-WKD6 ① | | | 3 | 2 | 2 | 1 | 1 | | | | | | | | | | |
| V7-W3TW | 4 | 4 | 3 | 2 | 1 | | | | | | | | | | | | |
| V7-WTF3,-WTS3 ② | 4 | 4 | 3 | 2 | 1 | | | | | | | | | | | | |
| V7-W3,-WD3, -WKD3,-WR3 | 4 | 4 | 3 | 2 | 1 | | | | | | | | | | | | |
| V7-WD4,-WD4C | 4 | 4 | 3 | 2 | 2 | 1 | | | | | | | | | | | |

- ① For multiple wire combinations consult factory for latest wire combination information.
- ② V7-WTF... & V7-WTS... blocks have been tested for 4 - #26 and #24 AWG wires.
- ③ These products have a maximum European wire size of 2.5 mm², yet they are UL Listed for #12 AWG wire.