

Series L2 Rotary Cam Switches

Attractive design,
reliable operation
and high quality for
any application up
to 25 Amps



Sprecher + Schuh's comprehensive line of L2 rotary cam switches are available for all control and load applications up to 25 amps. The line is modular and has many convenience and safety features. A well thought out ordering system provides many standard and nonstandard configurations, that are many times available off the shelf.

Any switch configuration...

Two frame sizes provide control and load switching up to 25 amps. Both frame sizes are available in panel mount and base mount for total flexibility. A wide range of switching configurations are offered, as listed below.

...For any application

L2 control and load switches are UL listed, CSA approved and comply with the most important international standards for use as:

- **Control switches** - for process control, making and breaking circuits and as instrument selector switches.
- **Motor switches** - as ON/OFF and reversing switches.
- **Multi-position load switches** - for the step control of loads such as heaters and furnaces.
- **Motor load disconnect switches** - for safely isolating circuits during repair and maintenance.
- **Emergency OFF switches** - for isolating circuits in case of danger or emergency situations. Can be equipped for locking in the OFF position.



Safety and quality

The L2's sturdy design incorporates a positive switching action with a clearly designed switching point. Switch bodies are touch-safe (IP20) and manufactured from self-extinguishing materials corresponding to Class UL 94 V0. All control knobs and shafts are spray proof and dust proof to IP65.

Modular and flexible

The same switch handle assemblies and shaft extension systems are used for both our L2 control switches and L7 disconnect switches. This reduces inventory, simplifies stocking and allows you to put together the ideal switch for your application quickly and easily.

Simple assembly and fast installation

Shaft extensions and door interlocks snap-on quickly without tools, saving time during assembly. Captive terminals are shipped open and are totally accessible regardless of whether the switch is base mounted or panel mounted. Screwdriver guides and clear terminal markings reduce wiring mistakes and speed installation.

In addition, most switch handle assemblies are available with either screw fixing or the central nut mounting system for total flexibility.

TIP!



To learn the basic differences between control, load and fusible disconnect switches and how to apply them, see our white paper Tech-LMSD in the online library.

K

L2 Rotary Cam Switches

How to order L2 control and load switches

A complete L2 switch is ordered with just two catalog numbers. The first number specifies the switch body and the second specifies the switch handle assembly. All L2 switch bodies come standard with a shaft and mounting screws for the switch handle assembly. Accessories such as shaft extensions and enclosures are ordered separately.

First determine the switch body you need from pages K4 through K7. Then turn to page K8 to choose a switch handle assembly. If necessary, turn to page K10 and K11 to determine the type and length of shaft extension you require.

Switch Handle Assemblies - page K8

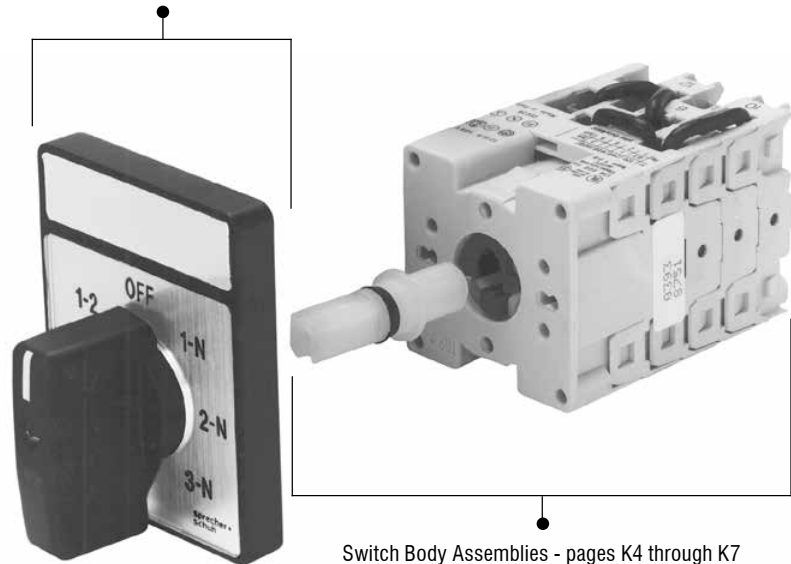

Switch Body Assemblies - pages K4 through K7

A comprehensive family of switches

The L2 line is part of an entire family of control and load switches available from Sprecher + Schuh.

For specialized switching requirements or large ampere applications up to 40A (@600V), our R-Line Rotary Cam Switches offer a broad selection and rugged quality. See the next chapter in this section entitled “R-Line Rotary Cam Switches” (K24) for ordering information.

Our modular L7 disconnect switches are rated to 100 amps for motor, loads and disconnect switching. They share many of the same components with the L2 line. A complete description and ordering information can be found in Section L of this catalog.

Rounding out our selection of “man-machine interfaces,” Sprecher + Schuh also offers a broad selection of 22mm pilot devices. See “Section H” in this catalog for ordering information.

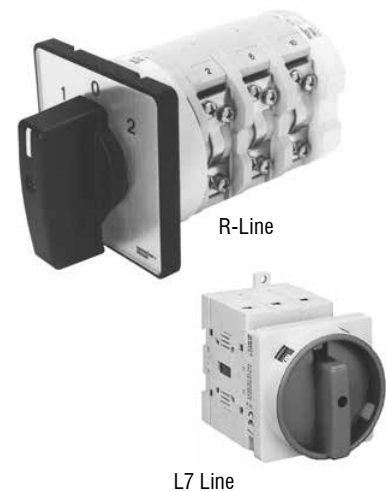

K

L2 Rotary Cam Switches

Switch Body Description			Switch Body Catalog Number							Switch Handle Code				
Function	Switch Angle	Poles/Switch Wafers	Panel Mount											
			12 Amp	Price	16 Amp	Price	20 Amp	Price	25 Amp		Price			
ON - OFF														
	90°	1 / 1	LE2-12-1751	31.26	LE2-16-1751	35.58	LE2-20-1751	41.82	LE2-25-1751	50.74	175 175I			
		2 / 1	LE2-12-1752	37.49	LE2-16-1752	42.37	LE2-20-1752	49.95	LE2-25-1752	60.60				
		3 / 2	LE2-12-1753	50.17	LE2-16-1753	56.41	LE2-20-1753	66.27	LE2-25-1753	78.84				
		4 / 2	LE2-12-1754	56.41	LE2-16-1754	63.32	LE2-20-1754	74.53	LE2-25-1754	88.58				
		5 / 3	LE2-12-1755	68.87	LE2-16-1755	77.36	LE2-20-1755	90.96	LE2-25-1755	106.82				
		6 / 3	LE2-12-1756	75.10	LE2-16-1756	84.16	LE2-20-1756	99.11	LE2-25-1756	116.67				
	90°	1 / 1	LE2-12-1781	31.26	LE2-16-1781	36.93	LE2-20-1781	43.27	LE2-25-1781	49.94	178 178I			
		2 / 1	LE2-12-1782	37.49	LE2-16-1782	44.07	LE2-20-1782	51.88	LE2-25-1782	60.99				
		3 / 2	LE2-12-1783	50.17	LE2-16-1783	58.57	LE2-20-1783	68.87	LE2-25-1783	78.68				
		4 / 2	LE2-12-1784	56.41	LE2-16-1784	65.70	LE2-20-1784	77.47	LE2-25-1784	92.08				
		Double Throw												
			45°	1 / 1	LE2-12-2251	37.49	LE2-16-2251	44.07	LE2-20-2251	51.54		LE2-25-2251	62.97	225
2 / 2	LE2-12-2252			56.41	LE2-16-2252	65.70	LE2-20-2252	77.47	LE2-25-2252	92.08				
3 / 3	LE2-12-2253			75.10	LE2-16-2253	87.45	LE2-20-2253	102.97	LE2-25-2253	121.20				
4 / 4	LE2-12-2254			94.02	LE2-16-2254	109.07	LE2-20-2254	128.67	LE2-25-2254	150.30				
5 / 5	LE2-12-2255			112.48	LE2-16-2255	130.83	LE2-20-2255	154.61	LE2-25-2255	178.97				
	60°			1 / 1	LE2-12-2501	37.49	LE2-16-2501	44.07	LE2-20-2501	51.88	LE2-25-2501	62.97	250	
		2 / 2	LE2-12-2502	56.41	LE2-16-2502	65.70	LE2-20-2502	77.47	LE2-25-2502	92.08				
		3 / 3	LE2-12-2503	75.10	LE2-16-2503	87.45	LE2-20-2503	102.97	LE2-25-2503	121.20				
		4 / 4	LE2-12-2504	94.02	LE2-16-2504	109.07	LE2-20-2504	128.67	LE2-25-2504	150.30				
		5 / 5	LE2-12-2505	112.48	LE2-16-2505	130.83	LE2-20-2505	154.61	LE2-25-2505	178.97				
			45°	1 / 1	LE2-12-3251	37.49	LE2-16-3251	44.07	LE2-20-3251	51.88	LE2-25-3251	62.97		325 325R
2 / 2	LE2-12-3252			56.41	LE2-16-3252	65.70	LE2-20-3252	77.47	LE2-25-3252	92.08				
3 / 3	LE2-12-3253			75.10	LE2-16-3253	87.45	LE2-20-3253	102.97	LE2-25-3253	121.20				
4 / 4	LE2-12-3254			94.02	LE2-16-3254	109.07	LE2-20-3254	128.67	LE2-25-3254	150.30				
	60°			1 / 1	LE2-12-3501	37.49	LE2-16-3501	44.07	LE2-20-3501	51.88	LE2-25-3501	62.97	350	
				2 / 2	LE2-12-3502	56.41	LE2-16-3502	65.70	LE2-20-3502	77.47	LE2-25-3502	92.08		
		3 / 3	LE2-12-3503	75.10	LE2-16-3503	87.45	LE2-20-3503	102.97	LE2-25-3503	121.20				
		4 / 4	LE2-12-3504	94.02	LE2-16-3504	109.07	LE2-20-3504	128.67	LE2-25-3504	150.30				
			90°	1 / 1	LE2-12-3751	37.49	LE2-16-3751	44.07	LE2-20-3751	51.88	LE2-25-3751	62.97		375
				2 / 2	LE2-12-3752	56.41	LE2-16-3752	65.70	LE2-20-3752	77.41	LE2-25-3752	92.08		
3 / 3	LE2-12-3753			75.10	LE2-16-3753	87.45	LE2-20-3753	102.97	LE2-25-3753	121.20				
4 / 4	LE2-12-3754			94.02	LE2-16-3754	109.07	LE2-20-3754	128.67	LE2-25-3754	150.30				
	45°			1 / 1	LE2-12-3261	37.49	LE2-16-3261	45.74	LE2-20-3261	55.20	LE2-25-3261	63.59	325	
				2 / 2	LE2-12-3262	56.41	LE2-16-3262	65.28	LE2-20-3262	77.41	LE2-25-3262	82.55		
		3 / 3	LE2-12-3263	75.10	LE2-16-3263	89.20	LE2-20-3263	107.80	LE2-25-3263	120.73				

K
L2 Rotary Cam Switches

Ordering Instructions

- Specify Switch Body catalog# from top of column.
- Replace (▲) with Circuit Diagram Number (refer to pages K13-K16 for diagrams).
- Select Switch Handle Assembly from pages K8 using Switch Handle Code above (switch handles sold separately).
- Example: **LE2-16-1753** (Switch Body)
LFS2-A-4-175 (Switch Handle Assembly)

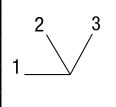
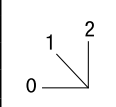
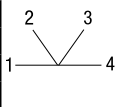
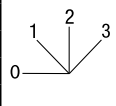
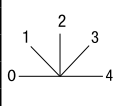
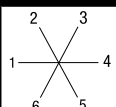
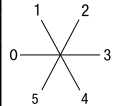
Switch Body Description			Switch Body Catalog Number								Switch Handle Code
Function	Switch Angle	Poles/Switch Wafers	Panel Mount								
			12 Amp	Price	16 Amp	Price	20 Amp	Price	25 Amp	Price	
3 Position											
	60°	1 / 2 2 / 3 3 / 5	LE2-12-4501	50.17	LE2-16-4501	58.00	LE2-20-4501	68.87	LE2-25-4501	81.89	450
			LE2-12-4502	75.10	LE2-16-4502	87.45	LE2-20-4502	102.97	LE2-25-4502	121.20	
			LE2-12-4503	106.48	LE2-16-4503	123.69	LE2-20-4503	153.24	LE2-25-4503	169.00	
3 Position (with OFF)											
	45°	1 / 1 2 / 2 3 / 3	LE2-12-5251	37.49			LE2-20-5252	77.47	LE2-25-5252	92.16	525
			LE2-12-5252	56.41					LE2-25-5253	121.20	
			LE2-12-5253	75.10	LE2-16-5253	87.45					
4 Position											
	60°	1 / 2 2 / 4 3 / 6	LE2-12-4511	56.41	LE2-16-4511	65.70					451
			LE2-12-4512	94.02	LE2-16-4512	109.07			LE2-25-4512	150.30	
			LE2-12-4513	131.40	LE2-16-4513	151.89			LE2-25-4513	209.00	
4 Position (with OFF)											
	45°	1 / 2 2 / 3 3 / 5	LE2-12-5261	50.17	LE2-16-5261	58.57	LE2-20-5261	68.87	LE2-25-5261	81.89	526
			LE2-12-5262	75.10	LE2-16-5262	87.45	LE2-20-5262	102.97	LE2-25-5262	121.20	
			LE2-12-5263	106.48	LE2-16-5263	131.01	LE2-20-5263	146.12	LE2-25-5263	169.00	
5 Position (with OFF)											
	45°	1 / 2 2 / 4 3 / 6	LE2-12-5271	56.41	LE2-16-5271	65.70	LE2-20-5271	77.47	LE2-25-5271	92.16	527
			LE2-12-5272	94.02	LE2-16-5272	109.07	LE2-20-5272	128.67	LE2-25-5272	149.30	
			LE2-12-5273	131.40	LE2-16-5273	151.89	LE2-20-5273	178.97	LE2-25-5273	209.00	
6 Position											
	60°	1 / 3	LE2-12-4531	75.10	LE2-16-4531	87.45	LE2-20-4531	102.97	LE2-25-4531	121.20	453
6 Position (with OFF)											
	60°	1 / 3 2 / 5 3 / 8	LE2-12-5531	68.87	LE2-16-5531	80.31	LE2-20-5531	93.05	LE2-25-5531	111.01	553
			LE2-12-5532	112.48	LE2-16-5532	130.83	LE2-20-5532	154.61	LE2-25-5532	178.97	
			LE2-12-5533	161.87	LE2-16-5533	188.94	LE2-20-5533	228.96	LE2-25-5533	263.58	



Ordering Instructions

- Specify Switch Body catalog# from top of column.
- Replace (▲) with Circuit Diagram Number (refer to pages K13-K16 for diagrams).
- Select Switch Handle Assembly from pages K8 using Switch Handle Code above (switch handles sold separately).
- Example: **LE2-16-1753** (Switch Body)
LFS2-A-4-175 (Switch Handle Assembly)

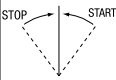
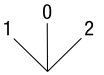
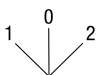
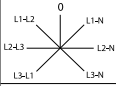
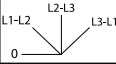
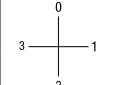







Switch Body Description			Switch Body Catalog Number								Switch Handle Code
Function	Switch Angle	Poles/ Switch Wafers	Panel Mount								
			12 Amp	Price	16 Amp	Price	20 Amp	Price	25 Amp	Price	
START - STOP											
	45°	1 / 1	LE2-12-9251	36.76	LE2-16-9251	44.07	LE2-20-9251	51.88	LE2-25-9251	63.59	925
REVERSING											
	45°	3 / 3	LE2-12-7303	68.87	LE2-16-7303	80.31	LE2-20-7303	94.47	LE2-25-7303	111.01	325
Two Speed Single Winding (Dahlander)											
	45°	3 / 4	LE2-12-7293	94.02	LE2-16-7293	53.70	LE2-20-7293	128.67	LE2-25-7293	150.30	325
Voltmeter											
	45°	NA / 3	LE2-12-8251	75.10	LE2-16-8251	104.06	LE2-20-8251	114.45	LE2-25-8251	120.73	825 825A
	45°	NA / 2	LE2-12-8271	56.41	LE2-16-8271	79.42	LE2-20-8271	87.42	LE2-25-8271	95.84	827 827A
Ammeter											
	90°	1 / 3	LE2-12-8751	75.10	LE2-16-8751	103.12	LE2-20-8751	113.42	LE2-25-8751	120.73	875
3 Current Transformers		2 / 5	LE2-12-8752	106.46	LE2-16-8752	135.87	LE2-20-8752	118.58	LE2-25-8752	177.86	



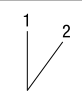

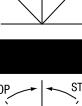
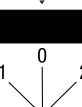

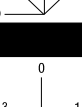
L2 Rotary Cam Switches

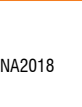



Ordering Instructions

- Specify Switch Body catalog# from top of column.
- Replace (▲) with Circuit Diagram Number (refer to pages K13-K16 for diagrams).
- Select Switch Handle Assembly from pages K8 using Switch Handle Code above (switch handles sold separately).
- Example: **LE2-16-1753** (Switch Body)
LFS2-A-4-175 (Switch Handle Assembly)

Switch Body Description			Switch Body Catalog Number							Switch Handle Code	
Function	Switch Angle	Poles/Switch Wafers	Base Mount								
			12 Amp	Price	16 Amp	Price	20 Amp	Price	25 Amp		Price
ON - OFF											
	90°	1 / 1	LA2-12-1751	36.58	LA2-16-1751	42.13	LA2-20-1751	48.26	LA2-25-1751	57.31	175 175I
		2 / 1	LA2-12-1752	42.82	LA2-16-1752	48.95	LA2-20-1752	56.41	LA2-25-1752	66.94	
		3 / 2	LA2-12-1753	54.94	LA2-16-1753	63.10	LA2-20-1753	72.94	LA2-25-1753	85.41	
		4 / 2	LA2-12-1754	60.82	LA2-16-1754	69.78	LA2-20-1754	81.11	LA2-25-1754	95.16	
		5 / 3	LA2-12-1755	72.94	LA2-16-1755	83.71	LA2-20-1755	97.64	LA2-25-1755	113.38	
		6 / 3	LA2-12-1756	78.84	LA2-16-1756	90.72	LA2-20-1756	105.57	LA2-25-1756	123.01	
	90°	1 / 1	LA2-12-1781	38.05	LA2-16-1781	41.49	LA2-20-1781	49.20	LA2-25-1781	59.13	178 178I
		2 / 1	LA2-12-1782	44.41	LA2-16-1782	50.85	LA2-20-1782	57.78	LA2-25-1782	69.67	
		3 / 2	LA2-12-1783	56.98	LA2-16-1783	65.47	LA2-20-1783	74.03	LA2-25-1783	88.69	
		4 / 2	LA2-12-1784	63.20	LA2-16-1784	72.02	LA2-20-1784	83.06	LA2-25-1784	98.78	
Double Throw											
	45°	1 / 1	LA2-12-2251	44.41	LA2-16-2251	50.85	LA2-20-2251	57.78	LA2-25-2251	65.00	225
		2 / 2	LA2-12-2252	63.20	LA2-16-2252	72.50	LA2-20-2252	84.28	LA2-25-2252	98.78	
	45°	1 / 1	LA2-12-3251	44.41	LA2-16-3251	50.85	LA2-20-3251	58.57			325 325R
		2 / 2	LA2-12-3252	63.20	LA2-16-3252	72.50	LA2-20-3252	84.28			
		3 / 3	LA2-12-3253	81.89	LA2-16-3253	94.24	LA2-20-3253	109.77			
		4 / 4	LA2-12-3254	100.70	LA2-16-3254	115.88	LA2-20-3254	135.37			
4 Position (with OFF)											
	45°	1 / 2	LA2-12-5261	56.98	LA2-16-5261	64.19	LA2-20-5261	74.03	LA2-25-5261	87.56	526
5 Position (with OFF)											
	45°	1 / 2	LA2-12-5271	63.20	LA2-16-5271	72.02	LA2-20-5271	83.06	LA2-25-5271	98.78	527
START - STOP											
	45°	1 / 1	LA2-12-9251	44.41	LA2-16-9251	49.58	LA2-20-9251	57.78	LA2-25-9251	69.06	925
REVERSING											
	45°	3 / 3	LA2-12-7303	75.66	LA2-16-7303	86.99	LA2-20-7303	101.38	LA2-25-7303	117.79	325
Voltmeter											
	45°	NA / 3	LA2-12-8251	81.89	LA2-16-8251	94.47	LA2-20-8251	107.43	LA2-25-8251	124.58	825 825A
	45°	NA / 2	LA2-12-8271	63.20							827 827A
Ammeter											
	90°	1 / 3 2 / 5	LA2-12-8751	81.89	LA2-16-8751	94.47	LA2-20-8751	107.43	LA2-25-8751	124.58	875

Switch Handle Assemblies

Switch Handle Assembly	Mounting Method	Frame Size	Catalog Number	Price each
 Type A - Type 12 Silver Legend Plate - Black Knob	Screw ①③	48 x 48	LFS2-A-4-*	10.20
		64 x 64	LFS2-A-6-*	13.50
	Central Nut ②③	48 x 48	LFC2-A-4-*	14.20
		48 x 48	LFS2-E-4-*	15.40
 Type E - Type 12 Silver Legend Plate - Black Knob	Screw ①③	64 x 64	LFS2-E-6-*	18.86
		48 x 48	LFC2-E-4-*	16.30
	Central Nut ②③	48 x 48	LFS2-I-4-*	10.20
		64 x 64	LFS2-I-6-*	13.50
 Type I - Type 12 Yellow Legend Plate - Red Knob	Central Nut ②③	48 x 48	LFC2-I-4-*	16.30
		 Type L - Type 12 Yellow Legend Plate - Red Knob	Screw ①③	48 x 48
64 x 64	LFS2-L-6-*			18.71
48 x 48	LFC2-L-4-*		16.30	





Switch Handle Assembly	Mounting Method	Frame Size	Catalog Number	Price each
 Type G - Type 12 Grey Frame - Black Handle	Screw ①	67 x 67	LFS2-G-6-175	25.08
	Central Nut ②	67 x 67	LFC2-G-6-175	28.50
 Type N - Type 12 Yellow Frame - Red Handle	Screw ①	67 x 67	LFS2-N-6-175	25.15
	Central Nut ②	67 x 67	LFC2-N-6-175	28.50
 Type B - Type 12 Grey Ring - Black Knob	Central Nut ②	NA	LFC2-B-001	14.20
 Type C - Type 12 Silver Legend Plate	Central Nut ②	48x48	LFC2-C◆-4-*	43.24

K
L2 Rotary Cam Switches

Ordering Instructions

- Specify Switch Body catalog# from top of column.
- Replace (*) with Switch Handle Code Number (refer to pages K9) for Legend Plate desired.

- Where applicable replace (◆) with Key Withdraw Code.

C =  D =  G =  H =  K = 

● Example: **LFC2-C◆-4-*** = **LFC2-CK-4-553**

- ① Mounting screws included with Switch Body Assy.
- ② Central Nut mounting method cannot be used on LA style Switch Body Assemblies.
- ③ To order Switch Handle Assembly without legend plate, replace (*) with "001".
- ④ LFS(C)2-G(N)-6-175 handles are marked "I-ON" and "O-OFF".

Switch Handle Codes

Switch Handle Code	Standard Legend Markings ④	Frame Size ①	Switch Handle Assembly Type														
			Screw Mount							Central Nut							
			A	E	I	L	G	N	A	E	I	L	C	G	N		
000		Standard	•	•	•	•			•	•	•	•	•				
		Larger	•	•	•	•					•						
175		Standard	•	•	•	•	•	•	•	•	•	•	•	•	•	•	•
		Larger	•	•	•	•					•						
175I		Standard	•	•	•	•	•	•	•	•	•	•	•	•	•	•	•
		Larger	•	•	•	•					•						
178		Standard	•	•	•			•	•	•	•	•					
		Larger	•	•	•					•							
178I		Standard	•	•	•			•	•	•	•	•					
		Larger	•	•	•					•							
225		Standard	•					•				•					
		Larger	•														
250		Standard	•					•				•					
		Larger	•														
325		Standard	•					•				•					
		Larger	•														
325R		Standard	•					•				•					
		Larger	•														
350 ②		Standard	•					•				•					
		Larger	•														
375		Standard	•					•				•					
		Larger	•														
450		Standard	•					•				•					
		Larger	•														

Switch Handle Code	Standard Legend Markings ④	Frame Size ①	Switch Handle Assembly Type														
			Screw Mount							Central Nut							
			A	E	I	L	G	N	A	E	I	L	C	G	N		
451		Standard	•												•		
		Larger	•														
453		Standard	•												•		
		Larger	•														
525		Standard	•												•		
		Larger	•														
526		Standard	•												•		
		Larger	•														
527		Standard	•												•		
		Larger	•														
553		Standard	•												•		
		Larger	•														
825		Standard	•												•		
		Larger	•														
825A		Standard	•												•		
		Larger	•														
827		Standard	•												•		
		Larger	•														
827A		Standard	•												•		
		Larger	•														
875		Standard	•												•	•	
		Larger	•														
925		Standard	•												•		
		Larger	•														

① Frame Size descriptions:

Type: A.E.I.&L C N & G
 Standard: **48x48** **48x48** **67X67**
 Larger: **64x64**

② Available with "MAN-O-AUTO" or "HAND-O-AUTO" legend marking.

③ LFS(C)2-G(N)-6-175 handles are marked "I-ON" and "O-OFF".

④ For legend plate markings not included here, see page K17 for Custom Name Plates. **NOTE: Types "N" and "G" are not available with custom markings.** Add the following price adder to the Switch Handle Assembly noted on page K8 .

Quantity: 1-4 5-19 20-99 100-199 200-499 500+
 Price Adder: **\$22.35** **\$12.38** **\$8.12** **\$3.96** **\$2.60** **\$0.00**



L2 Rotary Cam Switches

Modular shaft extension system

Shaft Extension Modules are ideal for lengthening the shaft of an LA2 switch up to 144mm (≈5.5"). These rugged polycarbonate modules are 24mm (≈15/16") long and snap on "piggyback" to one another without the use of tools. Strong center shafts interlock as each module is snapped together. The standard 44mm End Shaft supplied with every LA2 switch connects the last Extension Module with the Switch Handle Assembly. End Shafts of 52 and 57mm are also available, making this modular system versatile, fast and economical. Shaft Extension Modules are supplied two per package.



Determining modular shaft extension components

- Determine Mounting Depth. This is the distance from the inside mounting surface of the enclosure to the **outside surface** of the enclosure cover. See diagram below for details ❶.

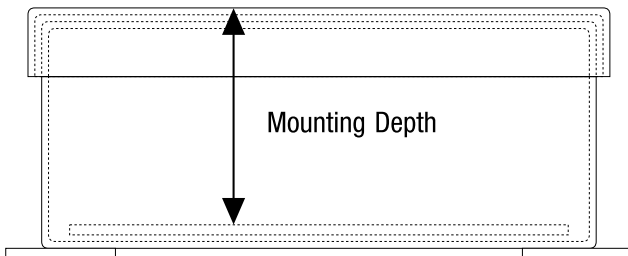

- If necessary convert Mounting Depth inches to millimeters (inches x 25.4 = millimeters).
- In the Modular Shaft Extension Table to the right, find the Mounting Depth in the column under the appropriate LA2 Switch Body.

NOTE: Table is based on an LA2 switch body with two wafers (3 or 4 pole). For a switch body with more or less wafers, add or subtract the following from overall Mounting Depth before referring to table:

LA2-12/16 Switch Body- ±10mm per wafer
 LA2-20/25 Switch Body- ±12.5mm per wafer

- Order the End Shaft and number of Extension Modules required for that Mounting Depth.

Modular Shaft Extension Components (LA2 Base Mount)

Component	Catalog Number	Price Each
44mm End Shaft ② (supplied with LA2 Switch Body Assembly)	LA2-G2830	4.18
52mm End Shaft	LA2-G3194	4.81
57mm End Shaft	LA2-G3195	5.47
Extension Module (two per pkg - priced per pkg)	LA2-G2853	8.70

Modular Shaft Extension Table

Number of Extension Modules	Required End Shaft	Mounting Depth (mm) ❶	
		Switch body LA2-12/16	Switch Body LA2-20/25
0	44mm ②	71.5 - 77.5	75 - 80.5
0	52mm	77 - 87	80 - 90
0	57mm	82 - 92	85 - 95
1	44mm ②	99.5 - 101.5	99 - 105
1	52mm	97.5 - 111	101 - 114.5
1	57mm	102.5 - 116	106 - 119.5
2	44mm ②	119.5 - 125.5	123 - 129
2	52mm	121.5 - 135	125 - 138.5
2	57mm	126.5 - 140	130 - 143.5
3	44mm ②	143.5 - 149.5	147 - 153
3	52mm	145.5 - 159	149 - 162.5
3	57mm	150.5 - 164	154 - 167.5
4	44mm ②	167.5 - 173.5	171 - 177
4	52mm	169.5 - 183	173 - 186.5
4	57mm	169.5 - 183	178 - 191.5
5	44mm ②	191.5 - 197.5	195 - 201
5	52mm	193.5 - 207	197 - 210.5
5	57mm	198.5 - 212	202 - 215.5
6	44mm ②	215.5 - 221.5	219 - 225
6	52mm	217.5 - 231	221 - 234.5
6	57mm	222.5 - 236	226 - 239.5

❶ For DIN rail mounted devices, remember to deduct the offset distance provided by the rail. For example, deduct 2.5mm from the Mounting Depth for switch bodies mounted on DIN 46277 rail.

❷ One 44mm End Shaft is supplied with all Switch Body Assemblies.

K
L2 Rotary Cam Switches

Metal shaft extension system

Adjustable metal shaft extensions snap on securely to LA2 switches via the same quick-connect design as shaft extension modules. Metal shafts are equipped with a door interlock and a padlock hasp for locking out the switch after the enclosure is opened (for outside lockout, select a Switch Handle Assembly with lockout capability).



Two standard lengths of these unique adjustable shafts are available. Metal shaft extensions mate with any of the standard Switch Handle Assemblies. All necessary hardware is supplied with the shaft.

Determining metal shaft extension

- Determine Mounting Depth. This is the distance from the inside mounting surface of the enclosure to the **outside surface** of the enclosure cover. See diagram below for details ❶.

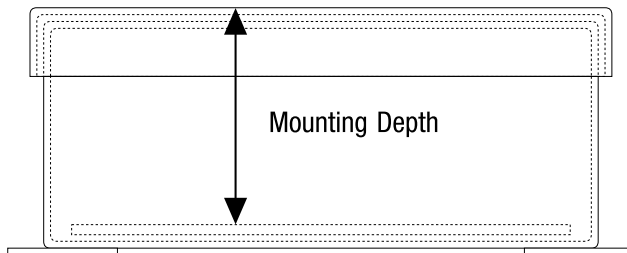

- If necessary convert Mounting Depth inches to millimeters (inches x 25.4 = millimeters).
- In the Metal Shaft Extension Table to the right, find the Mounting Depth in the column under the appropriate LA2 Switch Body.





NOTE: Table is based on an LA2 switch body with two wafers (3 or 4 pole). For a switch body with more or less wafers, add or subtract the following from overall Mounting Depth before referring to table:

LA2-12/16 Switch Body- ± 10mm per wafer
 LA2-20/25 Switch Body- ± 12.5mm per wafer

- Order the Metal Shaft Extension required for that Mounting Depth.

❶ For DIN rail mounted devices, remember to deduct the offset distance provided by the rail. For example, deduct 2.5mm from the Mounting Depth for switch bodies mounted on DIN 46277 rail.
 ❷ This dimension can be reduced by another 55mm by cutting the plastic sleeve and further cutting the metal shaft.



Metal Shaft Extension Components (LA2 Base Mount)



Component	Catalog Number	Price Each
Short Metal Shaft  Length: 10 . . . 235mm (4-21/64...9-1/4 in.)	LA2-G3393	34.20
Long Metal Shaft  Length: 230 . . . 350mm (9-3/64...13-51/64 in.)	LA2-G3394	44.38
 Insert - For modifying metal shaft to switch position	LA2-G3398	3.02
 Insert - For modifying metal shaft to switch any position (not lockable)	LA2-G3399	4.73

Metal Shaft Extension Table

Metal Shaft Extension	Mounting Depth (mm) ❶	
	Switch body LA2-12/16	Switch Body LA2-20/25
LA2-G3393	178 ❷ - 309	181.5 ❷ - 312.5
LA2-G3394	298 - 424	301.5 - 427.5

L2 Switch Accessories

Accessory	Description	Catalog No.	Price Each
 (Plastic Reducer included)	End Shaft for LE switch • Replacement 44mm shaft supplied standard with all switches • Sold only in packages of 5. Order 5 pieces to receive 1 pkg of 5.	L2-G3380	5.47
	Terminal cover 3 or 4 pole LE2-12/16 LE2-20/25 LA2-12/16 LA2-20/25	LE2-12-C4 LE2-20-C4 LA2-12-C4 LA2-20-C4	9.37 9.93 7.27 7.27
	Standard knob Black 37.5mm Black 48mm Red 37.5mm Red 48mm	L2-G3154N L2-G3155N L2-G3154R L2-G3155R	3.95 4.73 4.11 4.73
	Padlockable knob Black Red	L2-G2864N L2-G2864R	8.41
	Type "P" knob Black Red	L2-G2888N L2-G2888R	5.26
	Self contained knob - allows mounting LE2 switches without Switch Handle Assembly IP40 protection IP65 protection	L2-G2851N L2-G2854N	8.21 10.90
	Legend Plate - Blank for engraving Silver For 48 x 48 (or 62) For 64 x 64 (or 78) Yellow For 48 x 48 (or 62) For 64 x 64 (or 78)	LL2-A-4-000 LL2-A-6-000 LL2-I-4-000 LL2-I-6-000	6.26 7.27 6.26 6.27

Accessory	Description	Catalog No.	Price Each
	Switch handle assembly for 45mm standard cutout O-I OFF-ON Blank	LFS2-P-4-175 LFS2-P-4-175I LFS2-P-4-000	14.80
	ABS Enclosure – For High Impact Applications (IP66, UL 94 Flame Resistance - HB) With pre-drilled holes for 64 x 64 operator or larger 95x150x86mm 95x150x111mm Without holes 95x150x86mm 95x150x111mm	LA2-G3572 LA2-G3573 LA2-G3574 LA2-G3575	72.86 80.03 71.92 79.20
	Noryl Enclosure – For Corrosion Prone Applications (IP66, UL 94 Flame Resistance - V0) With pre-drilled holes for 64 x 64 operator or larger 95x150x86mm 95x150x111mm Without holes 95x150x86mm 95x150x111mm	LA2-G3576 LA2-G3577 LA2-G3578 LA2-G3579	102.07 112.26 100.71 112.26

Enclosure Selection Guide

Determine switch & number of poles; order enclosure and shaft required

Base Mount Switch	Poles	Use Enclosure...	Shaft Required ①	
LA2-12 & 16	1	LA2-G357(2,4,6,8)	LA2-G3195 Standard	
	2		LA2-G3194 Standard	
LA2-20 & 25	1		LA2-G357(3,5,7,9)	LA2-G3195 Standard
	2			LA2-G3194 Standard
LA2-12 & 16	3	LA2-G357(3,5,7,9)		LA2-G3195 Standard
	4			LA2-G3194 Standard
	5		LA2-G3194 Standard	
LA2-20 & 25	3	LA2-G357(3,5,7,9)	LA2-G3194 Standard	
	4		LA2-G3194 Standard	

① Order shafts from page K11.

K
L2 Rotary Cam Switches

Circuit Diagrams

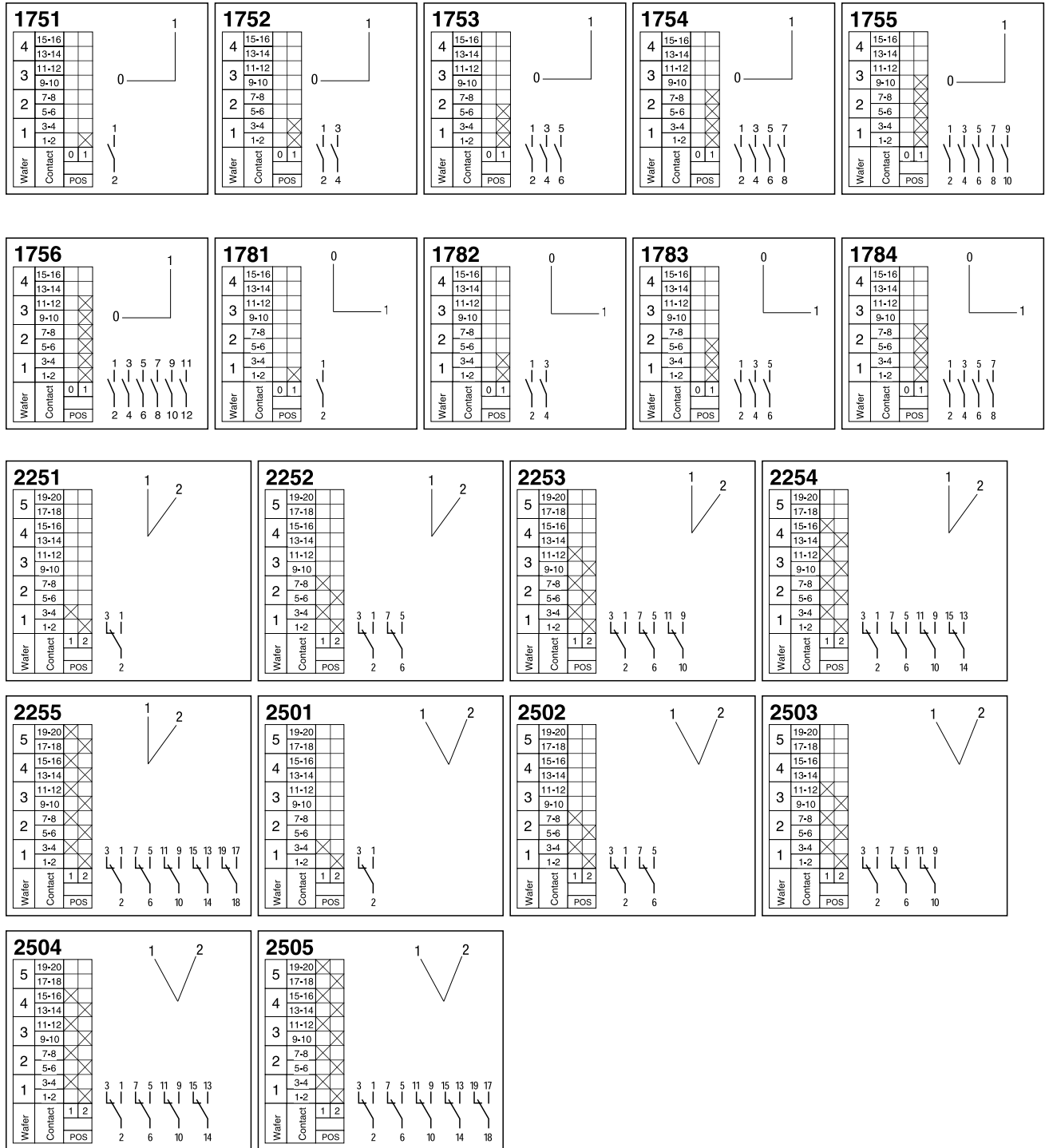

K
L2 Rotary Cam Switches

Circuit Diagrams

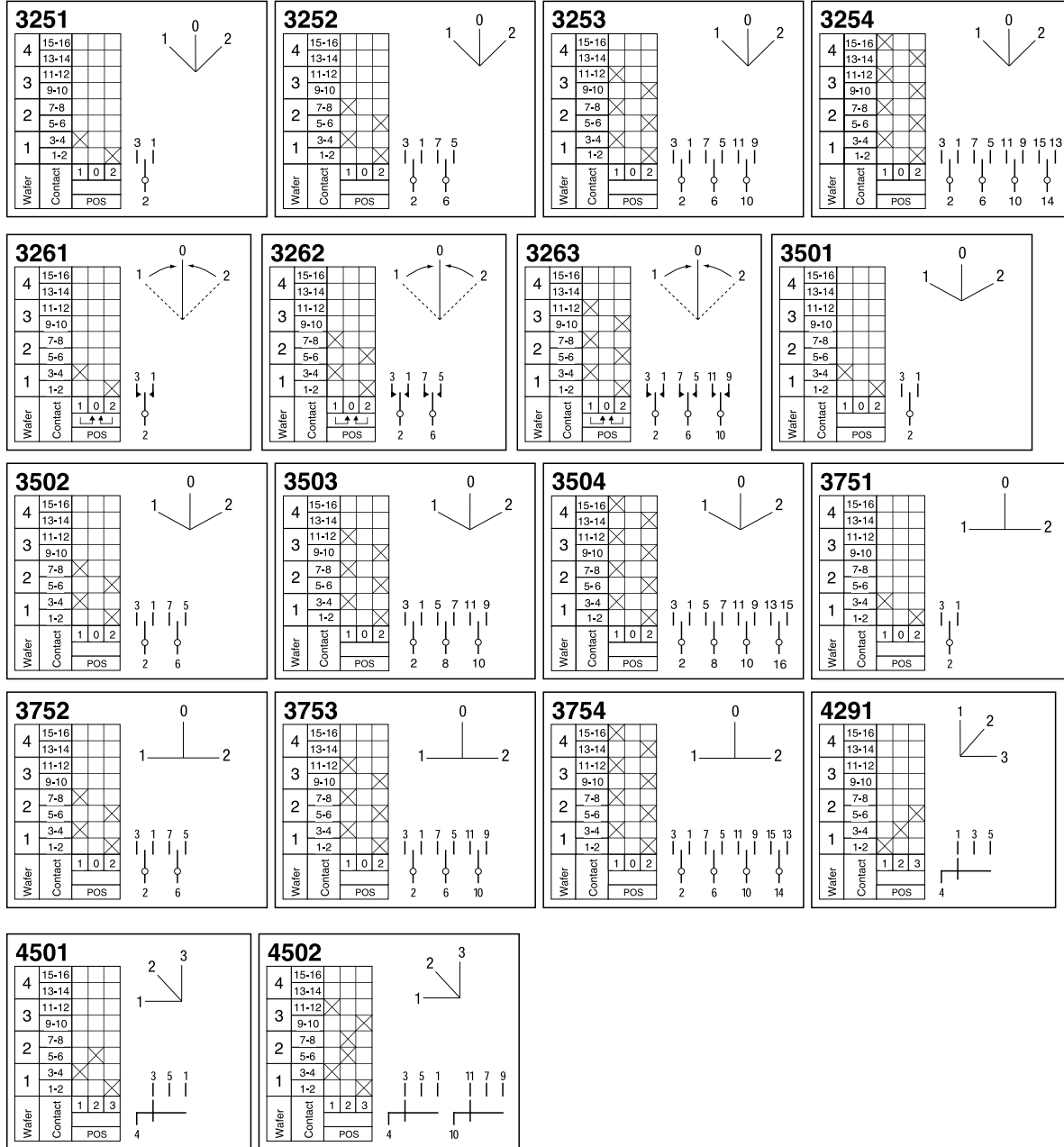

K

L2 Rotary Cam Switches

Circuit Diagrams

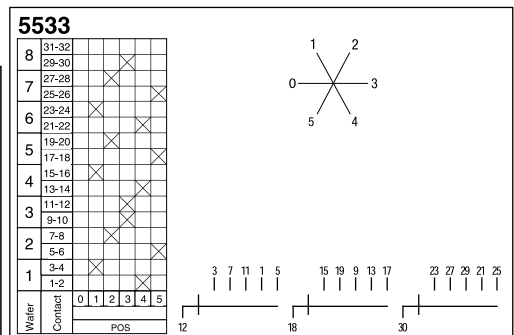
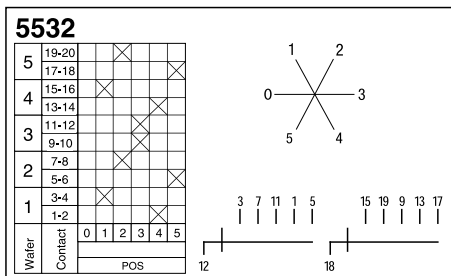
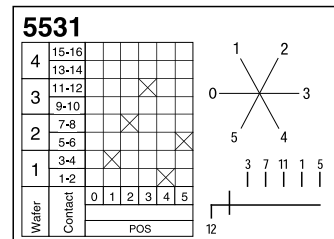
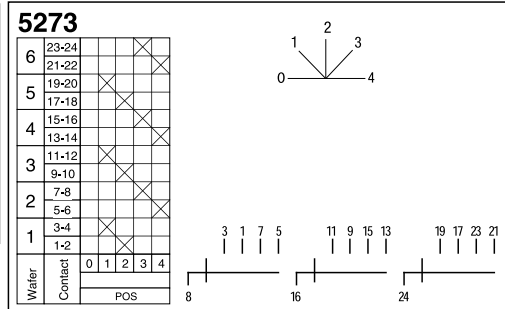
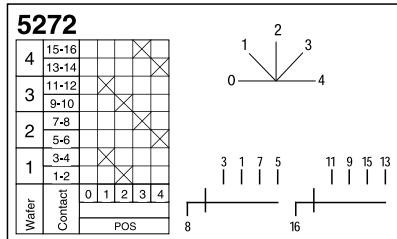
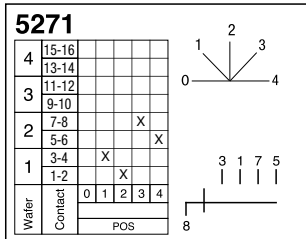
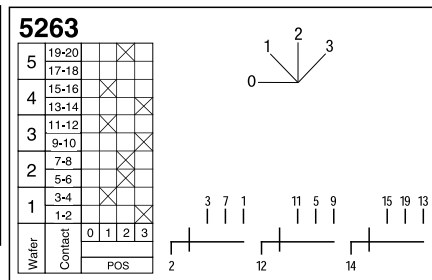
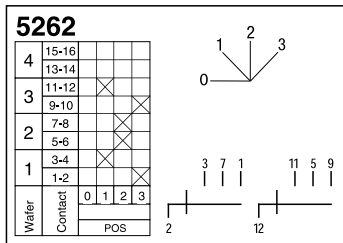
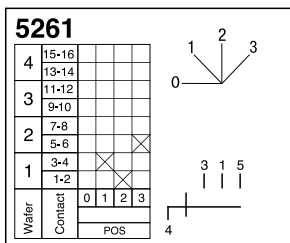
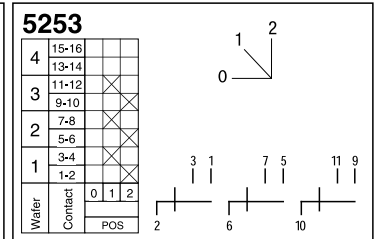
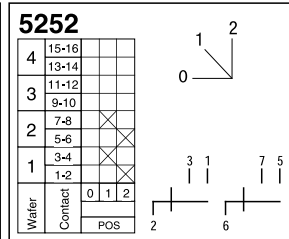
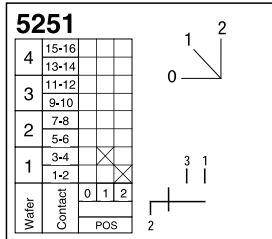
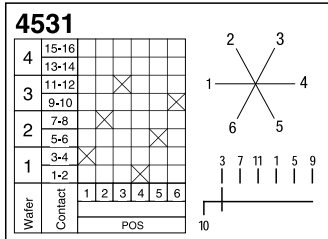
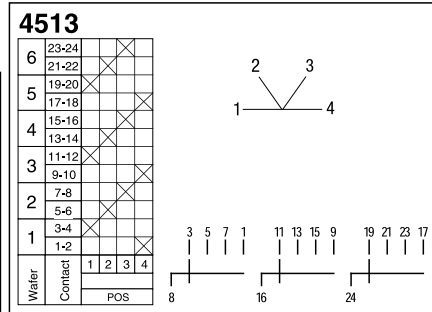
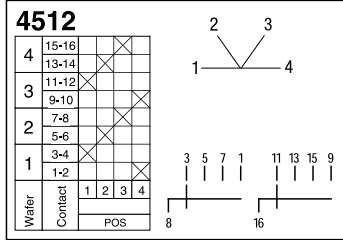
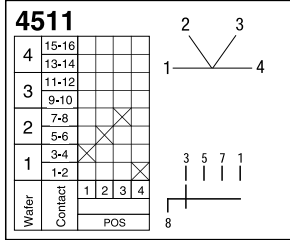

Circuit Diagrams

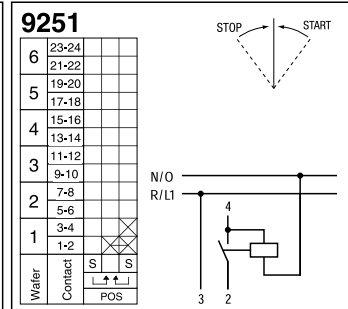
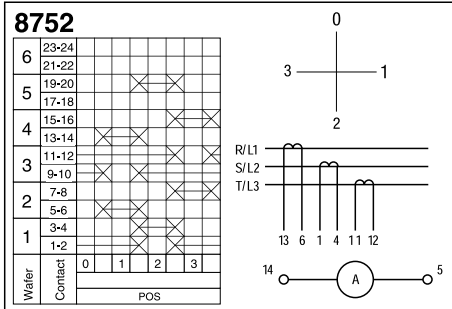
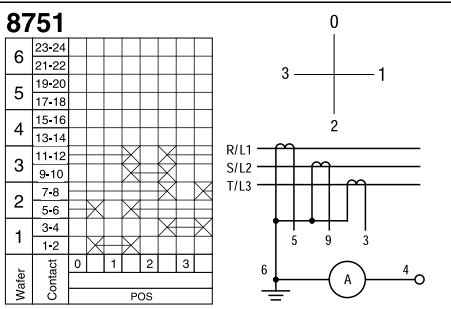
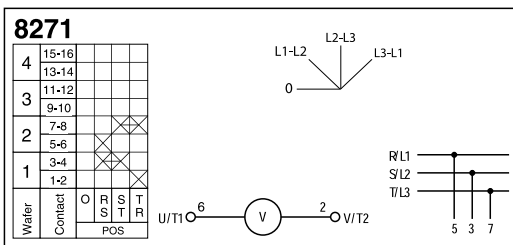
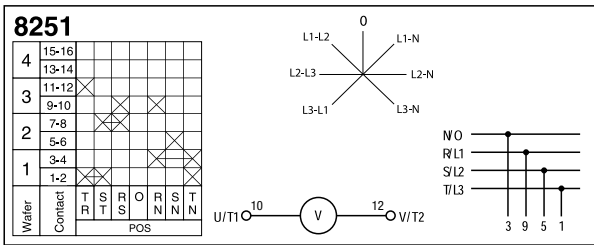
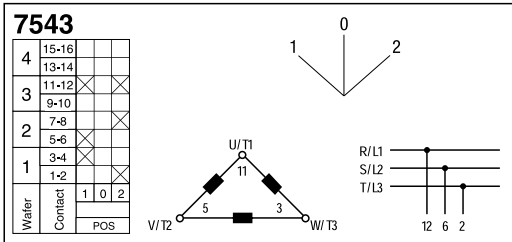
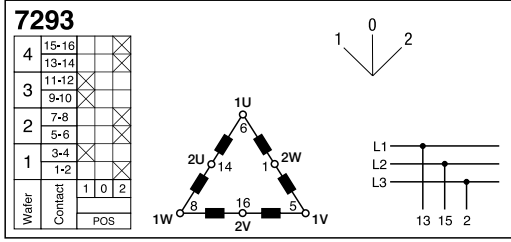
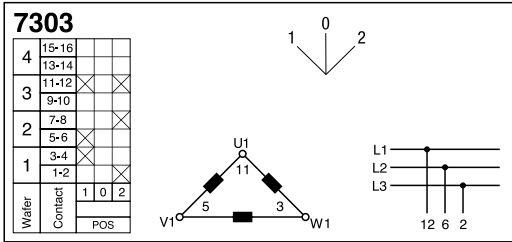

K
L2 Rotary Cam Switches

*Fax completed form to:
In USA 800-739-7370 or in Canada 905-475-0027*

USE ONE FORM FOR EACH NAME PLATE ORDERED

Customer Information:

Today's Date: _____ Order Form _____ of _____

Name: _____

Company: _____

Address: _____

City: _____ State: _____ Zip: _____

Telephone: _____

Job Reference/PO #: _____

Quantity:	<u>1-4</u>	<u>5-19</u>	<u>20-99</u>	<u>100-199</u>	<u>200-499</u>	<u>500+</u>
Price Adder:	\$22.35	\$12.38	\$8.12	\$3.96	\$2.60	\$0.00

NOTE: Types "N" and "G" are not available with custom markings.

Ordering Instructions:

- 1) For reference only, enter the switch and handle assembly part numbers in the spaces in the spaces to the right.
- 2) Based on your selection switch angle rotation, define the appropriate template figure and check mark the angle rotation (30/60/45/90°)
- 3) Enter the desired text in the spaces provides. Text limitation is defined by the amount of " " underlines provided per angle.
- 4) Use a new order form for each different custom nameplate.

SS-99-220-302
06/26/2016 CAS

Quantity required exactly like this one: _____

For Compatibility Verification please include the following:

Catalog Number of Switch to be used on

L			-		-				
---	--	--	---	--	---	--	--	--	--

Switch Handle Assembly to be used with

L			-		-				
---	--	--	---	--	---	--	--	--	--

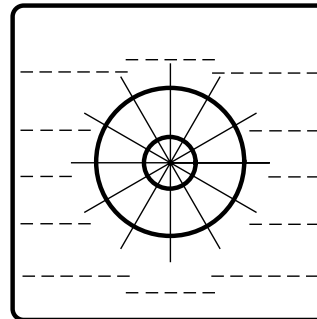

30° 60°

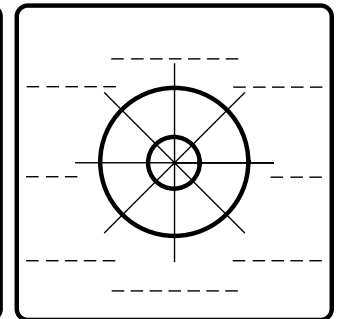

45° 90°



L2 Rotary Cam Switches

Technical Information

UL/CSA			L2-12	L2-16	L2-20	L2-25		
General use								
1-phase/2-phase, 3-phase/3 poles	Rated current	600 V	12	16	20	25		
Heavy Pilot Duty	code designation	AC	A600	A600	~	~		
Standard Duty	code designation	DC	~	~	~	~		
Alternating Current (IEC / EN 60947-3)								
Rated Voltage U_o	IEC-EN / UL-CSA	(V)	690/600	690/600	690/600	690/600		
Rated Isolation Voltage U_i	IEC / UL-CSA	(V)	690/600	690/600	690/600	690/600		
Rated impulse voltage U_{imp}	IEC	(kV)	6	6	6	6		
Test voltage U_i 1 min.		(kV)	2.5	2.5	2.5	2.5		
Rated frequency		(Hz)	50/60	50/60	50/60	50/60		
Thermal rated current I_{th} open 40°C		(A)	16	20	25	30		
Thermal rated current I_{the} enclosed 60°C		(A)	12	16	20	25		
Wasted power by 1 pole at thermal rated current I_{the}		(W)	0.3	0.5	0.6	0.9		
Rated Operating Current I_o								
AC-1/ AC21A	Switching resistive loads with slight overload	IEC947 690V	(A)	12	16	20	25	
AC-1	Non-inductive or slightly inductive loads inductive loads	SEV 690V	(A)	12	16	20	25	
AC-22A	Switching mixed resistive and inductive loads at slight overload	IEC947						
			220-500V	(A)	12	16	20	25
			600V	(A)	12	16	20	25
AC-15	Switching magnetic drives, motors, valves and solenoids	IEC	220-240V	(A)	5	6	7	8
			380-415V	(A)	3	4	5	6
			500V	(A)	2	2.5	3	4
Pilot Duty								
Rated current	Non-inductive or slightly inductive loads	UL/CSA – Heavy VAC UL/CSA ①	(A)	A600 12	A600 16	— 20	— 25	
Short Circuit Current								
	Max. fuse rating of circuit	(gL characteristic)	(A)	35	35	60	80	
	Rated conditional		(kA)	5	5	5	5	
Rated Operating Powers								
AC-2	Slip ring motors, starting induction motors, reversing and plugging, wye-delta starting	IEC/VDE/BS	240V	(kW)	3	4	5.5	5.5
			380V	(kW)	5.5	7.5	9	13
			3Ø 415V	(kW)	5.5	7.5	9	13
			3 pole 440V	(kW)	5.5	7.5	9	13
			500V	(kW)	7.5	10	11	15
			660V	(kW)	7.5	10	11	15
AC-3	Starting squirrel-cage motors, interruption while running	IEC/VDE/BS	3Ø 220-240V	(kW)	2.2	3	4.5	5.5
			3 pole 380-440V	(kW)	4	5.5	7.5	11
			500V	(kW)	5.5	7.5	10	13
			660V	(kW)	5.5	7.5	8	11
			1Ø 110V	(kW)	0.75	1.1	1.2	1.6
			2 pole 220-240V	(kW)	1.3	2.2	2.5	3.2
	380-440V	(kW)	2.2	3.7	4.5	5.5		

① Suitable for switching off load (AC-20) above 660V, but only up to 660V for switches with screws at the rear (LE switches).

Technical Information

				L2-12	L2-16	L2-20	L2-25							
Rated Operating Loads (cont.) IEC/VDE/BS														
AC-4	Starting squirrel-cage motors, reversing, braking, plugging	3Ø 3 pole	220-240V (kW) 380-415V (kW) 440-550V (kW) 660V (kW)	0.75 1.5 1.5 —	1.5 2.2 2.2 —	3 3.7 3.7 —	4 5.5 5.5 —							
AC-23A	Periodic switching of motors or other highly inductive loads.	3Ø 3 pole 1Ø 2 pole	220-240V (kW) 380-440V (kW) 500V (kW) 660V (kW) 110V (kW) 220-240V (kW) 380-440V (kW)	2.2 4 5.5 5.5 0.75 1.3 2.2	3 5.5 7.5 7.5 1.1 2.2 3.7	4.5 7.5 10 8 1.2 2.5 4.5	5.5 11 13 11 1.6 3.2 5.5							
Rated Power UL/CSA				(FLA)	(FLA)	(FLA)	(FLA)							
	Normal motor load full voltage rating (similar to AC-3)	3Ø 3 pole	120V (HP) 240V (HP) 480V (HP) 600V (HP)	1 (7.2) 2 (6.8) 5 (7.6) 5 (6.1)	1.5 (12.0) 3 (9.6) 7.5 (11.0) 7.5 (9.0)	2 (13.6) 4 (12.4) 8 (11.6) 10 (11.0)	3 (19.2) 6 (18.0) 12 (17.0) 15 (17.0)							
		1Ø 2 pole	120V (HP) 240V (HP)	0.5 (9.8) 1 (8.0)	0.75 (13.8) 1.5 (10.0)	1 (16) 2 (12)	1.5 (20.0) 3 (17.0)							
DC Switch Ratings				Contacts in Series										
				1	2	3	4	5	6	8				
Rated Current I_e														
	Rated Voltage [V]		24	48	72	96	120	144	192	[A]	12	16	20	22
DC-21A			48	96	144	192	240	288	384	[A]	10	12	16	18
	For resistive loads $T \leq 1ms$		60	120	180	240	300	360	450	[A]	8	10	12	14
	$U_{e max} = 600V$		110	220	330	440	550	660	—	[A]	2	2.5	4	5
			220	440	660	—	—	—	—	[A]	0.5	0.6	0.7	0.8
			440	—	—	—	—	—	—	[A]	0.4	0.4	0.5	0.5
Rated Making/Breaking Capacity ($=1.5 \times I_e$)														
	1.05 x rated voltage [V]		25.2	50.4	75.6	100.8	126	151.2	201.6	[A]	18	24	30	33
			50.4	100.8	151.2	201.6	252	302.4	403.2	[A]	15	21	24	27
	For resistive loads $T \leq 1ms$		63	126	189	252	315	378	504	[A]	12	18	18	21
	$U_{e max} = 600V$		115.5	231	346.5	462	577.5	—	—	[A]	3	4.5	6	7.5
			231	462	—	—	—	—	—	[A]	0.75	1.12	1.05	1.2
			462	—	—	—	—	—	—	[A]	0.52	0.78	0.47	0.75
Rated Current I_e														
	Rated voltage [V]		24	48	72	96	120	144	192	[A]	8	10	12	14
			30	60	90	120	150	180	240	[A]	4.5	5.5	7	8
	For inductive loads $T = 50ms$		48	96	144	192	240	288	384	[A]	1.5	2	2.5	3
	$U_{e max} = 600V$		60	120	180	240	300	360	450	[A]	1	1.2	1.5	1.8
			110	220	330	440	550	660	—	[A]	0.4	0.5	0.6	0.7
Rated Making/Breaking Capacity ($=1.1 \times I_e$)														
	1.1 x rated voltage [V]		26.4	52.8	79.2	105.6	132	158.4	184.8	[A]	8.8	11	13.2	15.4
			33	66	99	132	165	198	231	[A]	4.95	6.05	7.7	8.8
	For inductive loads $T = 50ms$		52.8	105.6	158.4	211.2	264	316.8	369.6	[A]	1.65	2.2	2.75	3.3
	$U_{e max} = 600V$		66	132	198	264	330	396	462	[A]	1.1	1.32	1.65	1.98
			121	242	363	484	605	—	—	[A]	4.95	6.05	7.7	8.8
Rated Power P_e														
	Rated voltage [V]		24	Contacts in Series					[kW]	0.12	0.15	0.20	0.25	
			24	1					[kW]	0.20	0.25	0.30	0.37	
DC-23A, DC-3, DC-5			48	2					[kW]	0.25	0.30	0.37	0.50	
	For inductive loads $T \leq 1ms$		48	3					[kW]	0.30	0.37	0.50	0.75	
			60	2					[kW]	0.25	0.30	0.37	0.50	
			60	4					[kW]	0.37	0.50	0.75	1.00	
			110	4					[kW]	0.50	0.75	1.00	1.20	
			110	6					[kW]	1.00	1.20	1.40	1.60	
			220	4					[kW]	0.37	0.50	0.75	1.00	
			220	6					[kW]	1.00	1.20	1.40	1.50	



L2 Rotary Cam Switches

Technical Information

			L2-12	L2-16	L2-20	L2-25
Rated Making/Breaking Capacity (=4 x I _n)						
1.05 x rated voltage [V]	Contacts in Series					
25.2	1	[kW]	20.0	25.0	33.3	41.6
25.2	2	[kW]	33.3	41.6	50.0	61.6
DC-23A, DC-3, DC-5	2	[kW]	21.0	25.0	30.8	41.6
For inductive loads T ≤ 7.5ms	3	[kW]	25.0	30.8	42.0	62.4
	2	[kW]	16.6	20.0	24.6	33.2
	4	[kW]	24.6	33.3	50.0	66.4
	4	[kW]	18.1	27.2	36.4	44.0
	6	[kW]	36.4	43.6	51.0	58.2
	4	[kW]	6.7	9.1	13.6	18.2
	6	[kW]	18.1	21.8	25.2	27.2
Maximum Wire Gauges						
Rigid Wire		AWG	(2)18...12	(2)18...12	(2)16...10	(2)16...10
		[mm ²]	(2)1...2.5	(2)1...2.5	(2)1.5...6	(2)1.5...6
Fine Strands		AWG	(2)18...12	(2)18...12	(2)16...10	(2)16...10
		[mm ²]	(2)1...2.5	(2)1...2.5	(2)1.5...4	(2)1.5...4
Max. Torque Ratings						
		[lb-in]	9	9	10.6	10.6
		[Nm]	1	1	1.2	1.2
Protection Class						
Switch Handle Assembly						
LFS2-UL			Type 12	Type 12	Type 12	Type 12
G(N)-6...						
All others	IEC 529		IP66	IP66	IP66	IP66
Switch Body	IEC 529		IP20	IP20	IP20	IP20
Mechanical Life						
	Millions of operations		1	1	1	1
Rated Breaking Capacity						
220V		(A)	72	96	128	176
Power factor			0.65	0.65	0.65	0.35
380V		(A)	72	96	128	176
Power factor			0.65	0.65	0.65	0.35
660V		(A)	53	72	86	112
Power factor			0.65	0.65	0.65	0.65
Ambient Temperature			(F°)	(F°)	(F°)	(F°)
Operation	Min...Max	(C°)	-25...+60 (-13...+140)	-25...+60 (-13...+140)	-25...+60 (-13...+140)	-25...+60 (-13...+140)
Storage only	Min...Max	(C°)	-40...+80 (-40...+176)	-40...+80 (-40...+176)	-40...+80 (-40...+176)	-40...+80 (-40...+176)
Maximum Altitude (without derating)			(m)	≤2000	≤2000	≤2000
			(ft.)	≤6561	≤6561	≤6561
Maximum Mechanical Operations (without derating)			(cycle/hr.)	1200	1200	1200
Maximum Electrical Operation (without derating)			(cycle/hr.)	120	120	120

LE2 Panel Mount - Screw Fixing

Dimensions are in millimeters (inches). Dimensions not intended for manufacturing purposes.

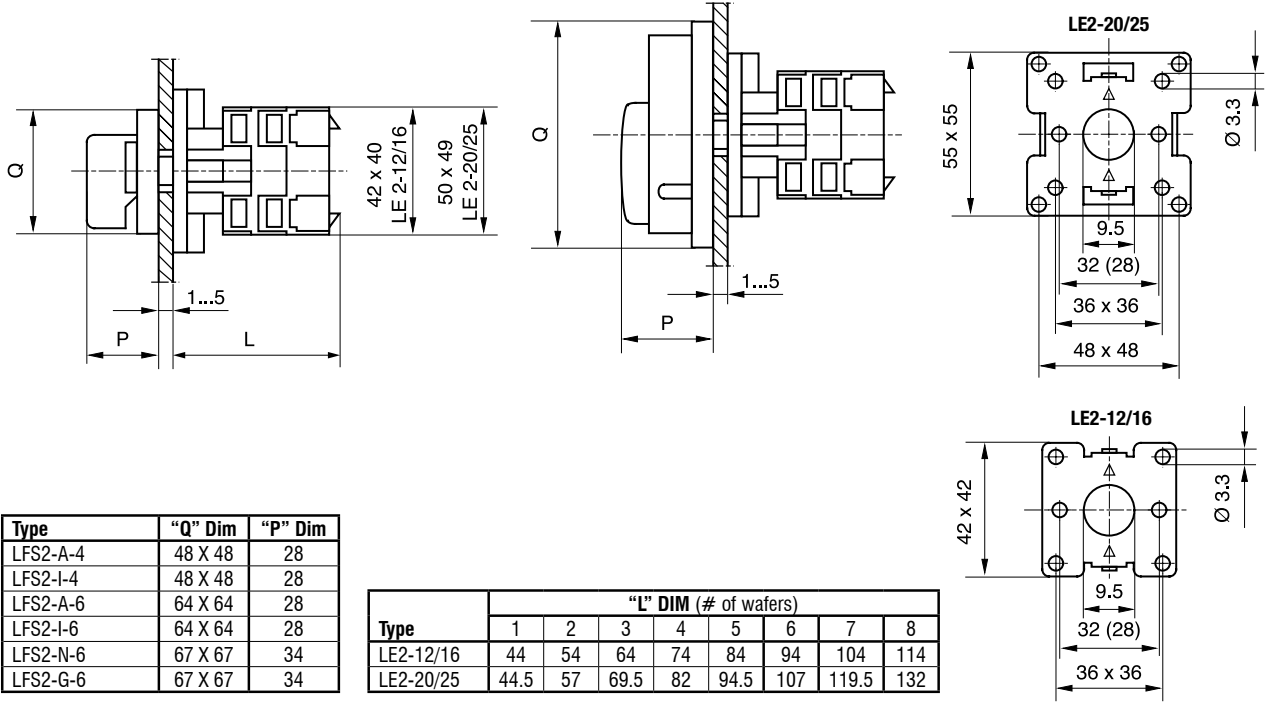

LE2 Panel Mount - Central Nut Fixing

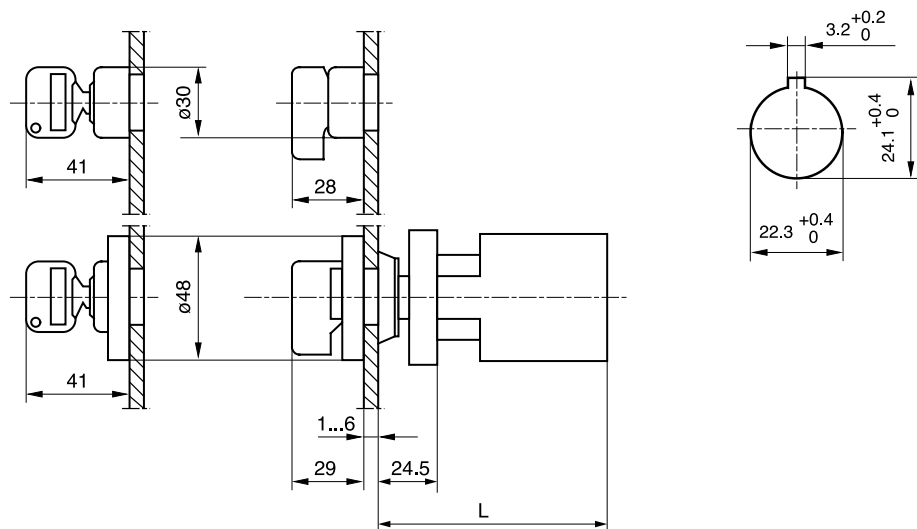

Type	"L" DIM (# of wafers)							
	1	2	3	4	5	6	7	8
LE2-12/16	67.5	77.5	87.5	97.5	107.5	117.5	127.5	137.5
LE2-20/25	69	81.5	94	106.5	119	131.5	144	156.5

LA2 Base Mount

Dimensions are in millimeters (inches). Dimensions not intended for manufacturing purposes.

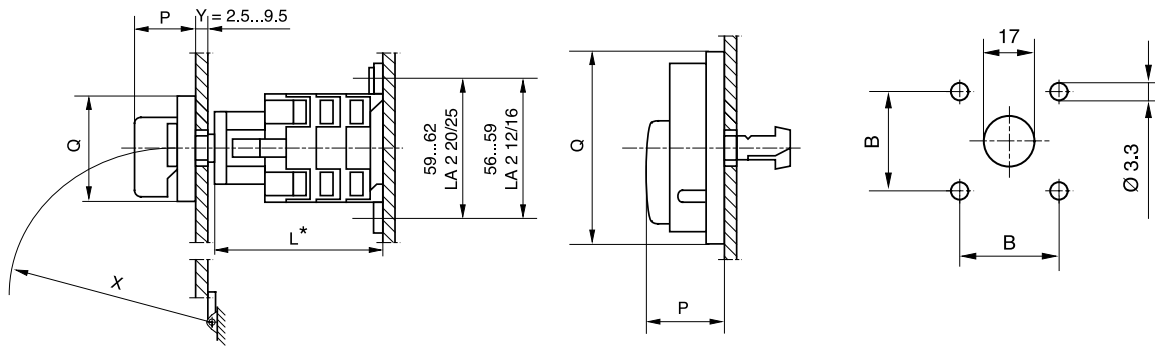

Type	"Q" Dim	"P" Dim	"B" Dim
LFS2-A-4	48 X 48	28	36
LFS2-I-4	48 X 48	28	36
LFS2-A-6	64 X 64	28	48
LFS2-I-6	64 X 64	28	48
LFS2-N-6	67 X 67	34	48
LFS2-G-6	67 X 67	34	48

Type	"L" DIM (# of wafers)			
	1	2	3	4
LA2-12/16	58	68	78	88
LA2-20/25	59	71.5	84	96.5

* Add 2.5mm for DIN rail 46277.

LA2 Base Mount with Modular Shaft Extensions

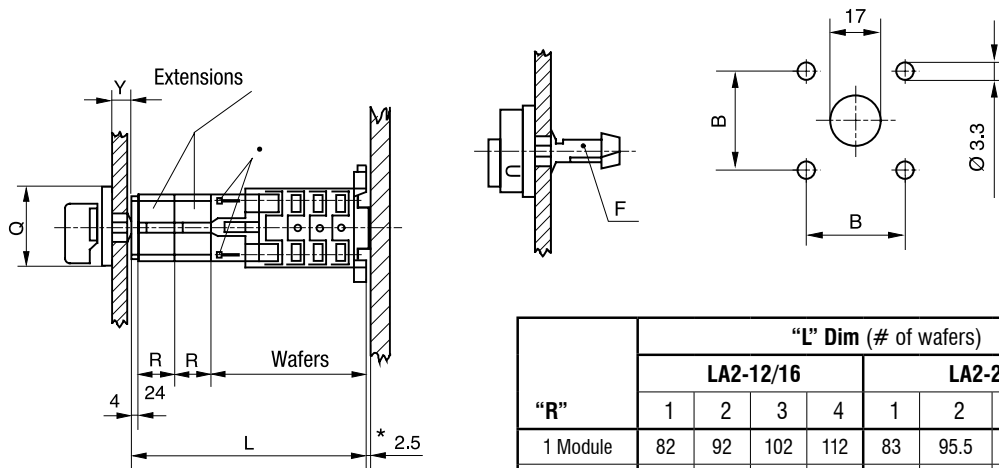

Type	"Q" Dim	"B" Dim
LFS2-A-4	48 X 48	36
LFS2-I-4	48 X 48	36
LFS2-A-6	64 X 64	48
LFS2-I-6	64 X 64	48
LFS2-N-6	67 X 67	48
LFS2-G-6	67 X 67	48

Shaft "F"	"Y" Dim
LA2-G2830	2.5-9.5
LA2-G3194	9 - 18
LA2-G3195	14 - 23

"R"	"L" Dim (# of wafers)							
	LA2-12/16				LA2-20/25			
	1	2	3	4	1	2	3	4
1 Module	82	92	102	112	83	95.5	108	120.5
2 Modules	106	116	126	136	107	119.5	132	144.5
3 Modules	130	140	150	160	131	143.5	156	168.5
4 Modules	154	164	174	184	155	167.5	180	192.5
5 Modules	178	188	198	208	179	191.5	204	216.5
6 Modules	202	212	222	232	203	215.5	228	240.5

* Add 2.5mm for DIN rail 46277.

• With more than 4 modules attach the first one to the switch with the screws supplied with the LA2-G2853.

LA2 Base Mount with Metal Shaft Extension

Dimensions are in millimeters (inches). Dimensions not intended for manufacturing purposes.

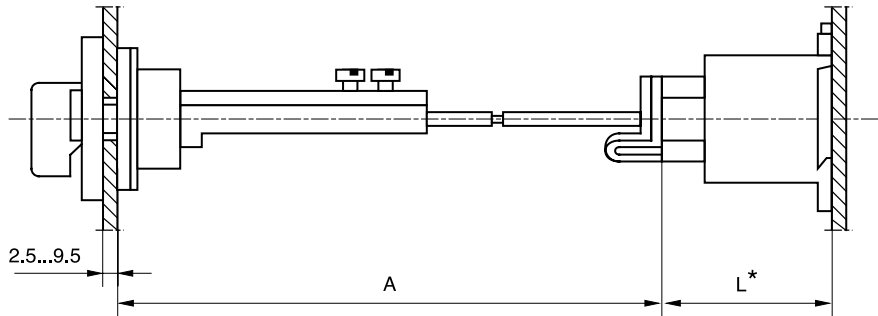

Type	"L" DIM (# of wafers)			
	1	2	3	4
LA2-12/16	54	64	74	84
LA2-20/25	55	67.5	80	92.5

Type	"A" Dim
LA2-G3393	110 - 235
LA2-G3394	230 - 350

* Add 2.5mm for DIN rail 46277.

LA2 Base Mount with LFS2-P-4

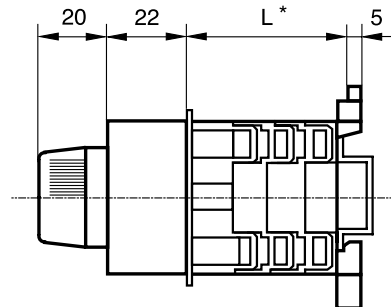

Type	"L" DIM (# of wafers)			
	1	2	3	4
LA2-12/16	35	45	55	65
LA2-20/25	35.5	48	60.5	73

* Add 2.5mm for DIN rail 46277.