

5 A modular SSR, 1 NO AC output

- 17.5 mm housing
- 60 to 240 V AC output (with back to back SCR)
- 5 kV (1.2/50 μs) insulation between Input and Output
- Zero-crossing and random switch-on versions available
- High switching speed
- High endurance
- Silent switching
- Spark and bounce-free switching
- Low control power
- 3-phase general purpose
- 35 mm rail (EN 60715) mount

77.01

Screw terminal



* See L77-3 diagram page 11

** See L77-1 and L77-2 diagrams page 10

For outline drawing see page 14

Output specification

| | | | | |
|--|-----------------|----------|----------------|--|
| Output configuration | 1 NO (SPST-NO) | | 1 NO (SPST-NO) | |
| Rated current I _N /Max. peak current* (10 ms) | A | 5/300* | 5/300* | |
| Rated voltage | V AC (50/60 Hz) | 230 | 230 | |
| Switching voltage range | V AC (50/60 Hz) | 48...265 | 48...265 | |
| Repetitive peak off-state voltage | V _{pk} | 800 | 800 | |
| Rated load AC7a (cos φ = 0.8) | A | 5 | 5 | |
| Rated load AC15 | A | 5 | 3 | |
| Single phase motor rating (230 V AC) | kW | — | 0.1 | |
| Nominal lamp rating: | | | | |
| 230 V incandescent/halogen W | | 1000 | 800 | |
| fluorescent tubes with electronic ballast W | | 1000 | 800 | |
| fluorescent tubes with electromechanical ballast W | | 1000 | 800 | |
| CFL W | | 800 | 400 | |
| 230 V LED W | | 800 | 400 | |
| LV halogen or LED with electronic ballast W | | 800 | 400 | |
| LV halogen or LED with electromechanical ballast W | | 1000 | 800 | |
| Minimum switching current @ 230 V | mA | 100 | 100 | |
| Typical "OFF-state" leakage current @ 230 V | mA | 0.5 | 3.5 | |
| Max "ON-state" voltage drop @ 25 °C and 5 A/100 mA | V | 0.85/1.5 | 0.85/1.5 | |
| Power loss @ 5 A | W | 4 | 4 | |

Input specification

| | | | | | |
|-----------------------------------|--------------------|----------|----------|----------|----------|
| Nominal voltage (U _N) | V AC (50/60 Hz) | 24 | 230 | 24 | 230 |
| | V DC | 12...24 | — | 12...24 | — |
| Rated power | VA (50 Hz)/W | 0.6/0.5 | 3.6/0.3 | 0.6/0.5 | 3.6/0.3 |
| Operating range | V AC (50/60 Hz) | 16...32 | 90...265 | 16...32 | 90...265 |
| | V DC | 9.8...32 | — | 9.8...32 | — |
| Must drop-out voltage | V AC (50/60 Hz)/DC | 2.4 | 24 | 2.4 | 24 |

Technical data

| | | | |
|---|--------|----------------------|----------------------|
| Electrical life | cycles | 10 · 10 ⁶ | 10 · 10 ⁶ |
| Operate/release time | ms | 20/12 | 9/8 |
| Insulation between input and output (1.2/50 μs) | kV | 5 | 5 |
| Ambient temperature | °C | -20...+70** | -20...+70** |
| Protection category | | IP 20 | IP 20 |

Approvals (according to type)



77.01.x.xxx.8050



Zero-crossing switch-on Suggested applications:

- Lamp inrush current reduction (CFL - Compact Fluorescent energy-saving Lamps and similar)
- Heater control
- Solenoid, contactor driver

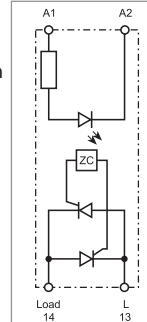

77.01.x.xxx.8051



Random switch-on Suggested applications:

- Finer control requiring short operate time (specially motor control)
- AC Input phase different from AC Output phase

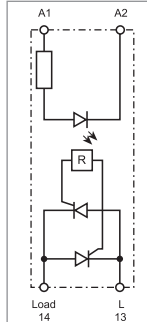

7 - 15 A modular SSR, 1 NO DC output

- 17.5 mm housing
- 2 versions, for 24 and 125 V DC mosfet output
- 4 kV (1.2/50 μ s) insulation between Input and Output
- Short circuit protection
- High switching speed
- High endurance
- Silent switching
- Spark and bounce-free switching
- Low control power
- Suitable for railway applications
- 35 mm rail (EN 60715) mount

77.01

Screw terminal



* See L77-12 and L77-13 diagrams page 10

For outline drawing see page 14

Output specification

| | | | |
|---|--------|-----------------|-----------------|
| Output configuration | | 1 NO (SPST-NO) | 1 NO (SPST-NO) |
| Rated current I_N /Max. peak current (10 ms) | A | 15/160 | 7/60 |
| Rated voltage | V DC | 24 | 125 |
| Switching voltage range | V DC | 16...32 | 43...140 |
| Rated load DC13 | A | 5 | 2.5 |
| DC motor rating | kW | 0.2 | — |
| Minimum switching current | mA | 100 | 50 |
| Typical "OFF-state" leakage current | mA | 3 | 6 |
| Max "ON-state" voltage drop @ 25 °C and I_N | V | 0.06 | 0.2 |
| Power loss @ I_N | W | 1 | 1.5 |
| Input specification | | | |
| Nominal voltage (U_N) | V DC | 6...24 | 6...24 |
| Rated power | W | 0.5 | 0.5 |
| Operating range | V DC | 4...36 | 4...36 |
| Must drop-out voltage | V DC | 3 | 3 |
| Technical data | | | |
| Electrical life | cycles | $10 \cdot 10^6$ | $10 \cdot 10^6$ |
| Operate/release time | ms | 0.05/2 | 0.05/2 |
| Insulation between input and output (1.2/50 μ s) | kV | 4 | 4 |
| Ambient temperature | °C | -20...+70* | -20...+70* |
| Protection category | | IP 20 | IP 20 |

Approvals (according to type)**77.01.9.024.9024****24 V DC output switching
15 A rated****Applications in Energy,
Automation and Machines:**

- Control of electric, pneumatic and hydraulic electromagnetic valves
- Direct control of loads such as motors and electromagnets

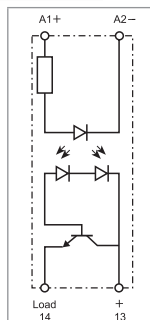
Simplified
circuit diagram**77.01.9.024.9125****110...125 V DC output
switching
7 A rated****Applications in Energy,
Automation and Machines:**

- Control of electric, pneumatic and hydraulic electromagnetic valves
- Direct control of loads such as motors and electromagnets

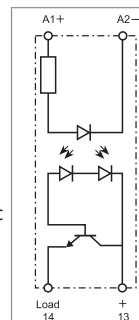
Simplified
circuit diagram

15 A modular SSR, 1 NO output

- 22.5 mm housing, heat-sink + plastic cover
- 24 to 277 V AC output (with triac)
- 6 kV (1.2/50 µs) insulation between Input and Output
- Zero-crossing and random switch-on versions available
- High switching speed
- High endurance
- Silent switching
- Spark and bounce-free switching
- Low control power
- 3-phase general purpose
- "Relay-style" terminal arrangement (input and output terminals on opposite sides)
- 35 mm rail (EN 60715) mount

77.11
Screw terminal



* See L77-7 diagram page 11
** See L77-6 diagrams page 10

For outline drawing see page 14

Output specification

| | | | | |
|--|----------------|--|----------------|--|
| Output configuration | 1 NO (SPST-NO) | | 1 NO (SPST-NO) | |
| Rated current I_N /Max. peak current* (10 ms) A | 15/400* | | 15/400* | |
| Rated voltage V AC (50/60 Hz) | 230 | | 230 | |
| Switching voltage range V AC (50/60 Hz) | 19...305 | | 19...305 | |
| Repetitive peak off-state voltage V_{pk} | 800 | | 800 | |
| Rated load AC7a (cos φ = 0.8, @ 25 °C) A | 20 | | 20 | |
| Rated load AC15 A | 15 | | 15 | |
| Single phase motor rating (230 V AC) kW | — | | 0.75 | |
| Nominal lamp rating: | | | | |
| 230 V incandescent/halogen W | 4000 | | 2500 | |
| fluorescent tubes with electronic ballast W | 4000 | | 2500 | |
| fluorescent tubes with electromechanical ballast W | 2000 | | 1000 | |
| CFL W | 3000 | | 1500 | |
| 230 V LED W | 3000 | | 1500 | |
| LV halogen or LED with electronic ballast W | 3000 | | 1500 | |
| LV halogen or LED with electromechanical ballast W | 3000 | | 1500 | |
| Minimum switching current @ 250 V mA | 100 | | 100 | |
| Typical "OFF-state" leakage current @ 250 V mA | 1 | | 1 | |
| Max "ON-state" voltage drop @ 25 °C and 15 A V | 1.55 | | 1.55 | |
| Power loss @ 15 A W | 14 | | 14 | |

Input specification

| | | | | | |
|--|-----------------|--------|----------|--------|----------|
| Nominal voltage (U_N) | V AC (50/60 Hz) | — | 230 | — | 230 |
| | V DC | 24 | — | 24 | — |
| Rated power VA (50 Hz)/W | | 0.4 | 7.5/0.9 | 0.4 | 7.5/0.9 |
| Operating range | V AC (50/60 Hz) | — | 40...305 | — | 40...305 |
| | V DC | 4...32 | — | 4...32 | — |
| Must drop-out voltage V AC (50/60 Hz)/DC | | —/2 | 6/— | —/2 | 6/— |

Technical data

| | | | | | |
|--|--|----------------------|-----------|----------------------|----------|
| Electrical life cycles | | 10 · 10 ⁶ | | 10 · 10 ⁶ | |
| Operate/release time ms | | < 10/< 10 | < 10/< 30 | < 1/< 10 | < 2/< 25 |
| Insulation between input and output (1.2/50 µs) kV | | 6 | | 6 | |
| Ambient temperature °C | | -20...+80** | | -20...+80** | |
| Protection category | | IP 20 | | IP 20 | |

Approvals (according to type)



77.11.x.xxx.8250



Zero-crossing switch-on
Suggested applications:

- Lamp inrush current reduction (CFL - Compact Fluorescent energy-saving Lamps and similar)
- Heater control
- Solenoid, contactor driver

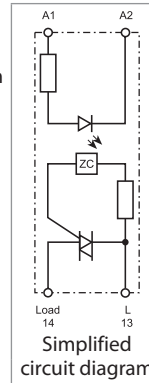

77.11.x.xxx.8251



Random switch-on
Suggested applications:

- Fine controls involving shorter time (specially motor control)

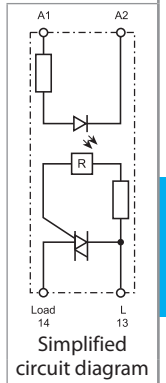

30 A modular SSR, 1 NO output

- 22.5 mm housing, heat-sink + plastic cover
- 60 to 440 V AC output (with back to back SCR)
- 6 kV (1.2/50 μ s) insulation between Input and Output
- Zero-crossing and random switch-on versions available
- High switching speed
- High endurance
- Silent switching
- Spark and bounce-free switching
- Low control power
- 3-phase general purpose
- "Relay-style" terminal arrangement (input and output terminals on opposite sides)
- 35 mm rail (EN 60715) mount

77.31

Screw terminal



* See L77-5 diagram page 11

** See L77-4 diagrams page 10

For outline drawing see page 14

Output specification

| Output configuration | 1 NO (SPST-NO) | | 1 NO (SPST-NO) | |
|--|----------------|--|----------------|--|
| Rated current I_N /Max. peak current* (10 ms) A | 30/520* | | 30/520* | |
| Rated voltage V AC (50/60 Hz) | 400 | | 400 | |
| Switching voltage range V AC (50/60 Hz) | 48...480 | | 48...480 | |
| Repetitive peak off-state voltage V_{pk} | 1100 | | 1100 | |
| Rated load AC7a (cos $\varphi = 0.8$) A | 30 | | 30 | |
| Rated load AC15 A | 20 | | 20 | |
| Single phase motor rating (230 V AC) kW | — | | 1.5 | |
| Nominal lamp rating: | | | | |
| 230 V incandescent/halogen W | 6000 | | 4500 | |
| fluorescent tubes with electronic ballast W | 6000 | | 4000 | |
| fluorescent tubes with electromechanical ballast W | 3000 | | 1800 | |
| CFL W | 4000 | | 2500 | |
| 230 V LED W | 4000 | | 2500 | |
| LV halogen or LED with electronic ballast W | 4000 | | 2500 | |
| LV halogen or LED with electromechanical ballast W | 4000 | | 2500 | |
| Minimum switching current @ 400 V mA | 300 | | 300 | |
| Typical "OFF-state" leakage current @ 400 V mA | 1 | | 1 | |
| Max "ON-state" voltage drop @ 25 °C and 30 A V | 0.85 | | 0.85 | |
| Power loss @ 30 A W | 16 | | 16 | |

Input specification

| | | | | | |
|---------------------------|--------------------|--------|----------|--------|----------|
| Nominal voltage (U_N) | V AC (50/60 Hz) | — | 230 | — | 230 |
| | V DC | 24 | — | 24 | — |
| Rated power @ U_{MAX} | VA (50 Hz)/W | 0.4 | 7.5/0.9 | 0.4 | 7.5/0.9 |
| Operating range | V AC (50/60 Hz) | — | 40...280 | — | 40...280 |
| | V DC | 4...32 | — | 4...32 | — |
| Must drop-out voltage | V AC (50/60 Hz)/DC | —/2 | 6/— | —/2 | 6/— |

Technical data

| | | | | | |
|--|--------|----------------------|-----------|----------------------|----------|
| Electrical life | cycles | 10 · 10 ⁶ | | 10 · 10 ⁶ | |
| Operate/release time | ms | < 10/< 10 | < 10/< 30 | < 1/< 10 | < 2/< 25 |
| Insulation between input and output (1.2/50 μ s) | kV | 6 | | 6 | |
| Ambient temperature | °C | -20...+80** | | -20...+80** | |
| Protection category | | IP 20 | | IP 20 | |

Approvals (according to type)**77.31.x.xxx.8050****Zero-crossing switch-on**
Suggested applications:

- Lamp inrush current reduction (CFL - Compact Fluorescent energy-saving Lamps and similar)
- Heater control
- Solenoid, contactor driver

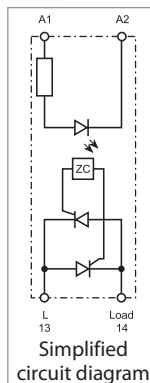
**77.31.x.xxx.8051****Random switch-on****Suggested applications:**

- Finer control requiring short operate time (specially motor control)

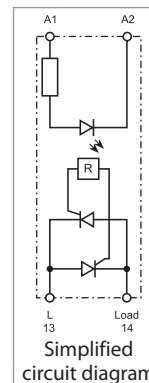

30 A modular SSR, 1 NO output

- 22.5 mm housing, heat-sink + plastic cover
- 60 to 440 V AC output (with back to back SCR)
- 6 kV (1.2/50 µs) insulation between Input and Output
- Zero-crossing and random switch-on versions available
- High switching speed
- High endurance
- Silent switching
- Spark and bounce-free switching
- Low control power
- 3-phase general purpose
- "Contactor-style" terminal arrangement (input and output terminals on adjacent sides)
- 35 mm rail (EN 60715) mount

77.31

Screw terminal



* See L77-5 diagram page 11

** See L77-4 diagrams page 10

For outline drawing see page 14

Output specification

| Output configuration | 1 NO (SPST-NO) | | 1 NO (SPST-NO) | |
|--|----------------|--|----------------|--|
| Rated current I_N /Max. peak current* (10 ms) A | 30/520* | | 30/520* | |
| Rated voltage V AC (50/60 Hz) | 400 | | 400 | |
| Switching voltage range V AC (50/60 Hz) | 48...480 | | 48...480 | |
| Repetitive peak off-state voltage V_{pk} | 1100 | | 1100 | |
| Rated load AC7a (cos φ = 0.8) A | 30 | | 30 | |
| Rated load AC15 A | 20 | | 20 | |
| Single phase motor rating (230 V AC) kW | — | | 1.5 | |
| Nominal lamp rating: | | | | |
| 230 V incandescent/halogen W | 6000 | | 4500 | |
| fluorescent tubes with electronic ballast W | 6000 | | 4000 | |
| fluorescent tubes with electromechanical ballast W | 3000 | | 1800 | |
| CFL W | 4000 | | 2500 | |
| 230 V LED W | 4000 | | 2500 | |
| LV halogen or LED with electronic ballast W | 4000 | | 2500 | |
| LV halogen or LED with electromechanical ballast W | 4000 | | 2500 | |
| Minimum switching current @ 400 V mA | 300 | | 300 | |
| Typical "OFF-state" leakage current @ 400 V mA | 1 | | 1 | |
| Max "ON-state" voltage drop @ 25 °C and 30 A V | 0.85 | | 0.85 | |
| Power loss @ 30 A W | 16 | | 16 | |

Input specification

| | | | | | |
|--|-----------------|--------|----------|--------|----------|
| Nominal voltage (U_N) | V AC (50/60 Hz) | — | 230 | — | 230 |
| | V DC | 24 | — | 24 | — |
| Rated power VA (50 Hz)/W | | 0.4 | 7.5/0.9 | 0.4 | 7.5/0.9 |
| Operating range | V AC (50/60 Hz) | — | 40...280 | — | 40...280 |
| | V DC | 4...32 | — | 4...32 | — |
| Must drop-out voltage V AC (50/60 Hz)/DC | | —/2 | 6/— | —/2 | 6/— |

Technical data

| | | | | | |
|--|--|----------------------|-----------|----------------------|----------|
| Electrical life cycles | | 10 · 10 ⁶ | | 10 · 10 ⁶ | |
| Operate/release time ms | | < 10/< 10 | < 10/< 30 | < 1/< 10 | < 2/< 25 |
| Insulation between input and output (1.2/50 µs) kV | | 6 | | 6 | |
| Ambient temperature °C | | -20...+80** | | -20...+80** | |
| Protection category | | IP 20 | | IP 20 | |

Approvals (according to type)



77.31.x.xxx.8070



Zero-crossing switch-on

Suggested applications:

- Lamp inrush current reduction (CFL - Compact Fluorescent energy-saving Lamps and similar)
- Heater control
- Solenoid, contactor driver

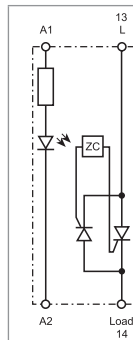

Simplified circuit diagram

77.31.x.xxx.8071



Random switch-on

Suggested applications:

- Fine controls involving shorter time (specially motor control)

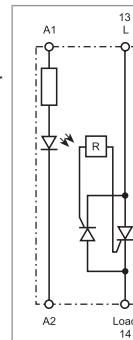

Simplified circuit diagram

25, 40 And 50 A panel SSR, "hockey puck" style

- "hockey puck" housing with cover
- 24 to 240 V AC output
- Zero-crossing version
- High switching speed
- High endurance
- Silent switching
- Spark and bounce-free switching
- Low control power
- 3-phase general purpose
- "Relay-style" terminal arrangement (input and output terminals on opposite sides)
- Mounting on heatsink with screws

77.x5
Screw terminal (plate clamp)



* See L77-11 diagrams page 11
** See L77-8, L77-9 and L77-10 diagrams page 11

For outline drawing see page 14

77.25.x.xxx.8250



Zero-crossing switch-on

- Output: 25 A/230 V AC
- Suggested applications: heater control

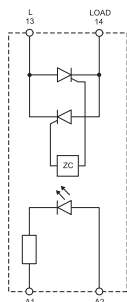

Simplified circuit diagram

77.45.x.xxx.8250



Zero-crossing switch-on

- Output: 40 A/230 V AC
- Suggested applications: heater control

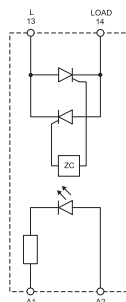

Simplified circuit diagram

77.55.x.xxx.8250



Zero-crossing switch-on

- Output: 50 A/230 V AC
- Suggested applications: heater control

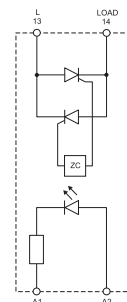

Simplified circuit diagram

Output specification

| | | | | |
|--|--|----------------|----------------|----------------|
| Output configuration | | 1 NO (SPST-NO) | 1 NO (SPST-NO) | 1 NO (SPST-NO) |
| Rated current I_N /Max. peak current* (10 ms) A | | 25/300* | 40/500* | 50/520* |
| Rated voltage V AC (50/60 Hz) | | 230 | 230 | 230 |
| Switching voltage range V AC (50/60 Hz) | | 21.6...280 | 21.6...280 | 21.6...280 |
| Repetitive peak off-state voltage V_{pk} | | 600 | 600 | 600 |
| Nominal lamp rating: | | | | |
| 230 V incandescent/halogen W | | 2000 | 4000 | 6000 |
| fluorescent tubes with electronic ballast W | | 2000 | 4000 | 6000 |
| fluorescent tubes with electromechanical ballast W | | 1000 | 2000 | 3000 |
| CFL W | | 800 | 3000 | 4000 |
| 230 V LED W | | 800 | 3000 | 4000 |
| LV halogen or LED with electronic ballast W | | 800 | 3000 | 4000 |
| LV halogen or LED with electromechanical ballast W | | 1000 | 3000 | 4000 |
| Minimum switching current @ 250 V mA | | 120 | 250 | 250 |
| Typical "OFF-state" leakage current @ 250 V mA | | 10 | 10 | 10 |
| Max "ON-state" voltage drop @ 25 °C and I_N V | | 1.6 | 1.6 | 1.6 |
| Power loss @ I_N W | | 40 | 64 | 80 |

Input specification

| | | | | | | | |
|---------------------------|--------------------|--------|----------|--------|----------|--------|----------|
| Nominal voltage (U_N) | V AC (50/60 Hz) | — | 230 | — | 230 | — | 230 |
| | V DC | 24 | — | 24 | — | 24 | — |
| Rated power @ U_{MAX} | VA (50 Hz)/W | —/0.6 | 2.4/— | —/0.6 | 2.4/— | —/0.6 | 2.4/— |
| Operating range | V AC (50/60 Hz) | — | 90...280 | — | 90...280 | — | 90...280 |
| | V DC | 3...32 | — | 3...32 | — | 3...32 | — |
| Must drop-out voltage | V AC (50/60 Hz)/DC | —/1 | 10/— | —/1 | 10/— | —/1 | 10/— |

Technical data

| | | | | | | | |
|---|--------|----------------------|-------|----------------------|-------|----------------------|-------|
| Electrical life | cycles | 10 · 10 ⁶ | | 10 · 10 ⁶ | | 10 · 10 ⁶ | |
| Operate/release time | ms | 10/10 | 40/80 | 10/10 | 40/80 | 10/10 | 40/80 |
| Insulation between input and output (1.2/50 μs) | kV | 5.6 | | 5.6 | | 5.6 | |
| Ambient temperature | °C | -30...+80** | | -30...+80** | | -30...+80** | |
| Protection category | | IP 20 | | IP 20 | | IP 20 | |

Approvals (according to type)



25, 40 And 50 A panel SSR, "hockey puck" style

- "hockey puck" housing with cover
- 48 to 600 V AC output
- Zero-crossing version
- High switching speed
- High endurance
- Silent switching
- Spark and bounce-free switching
- Low control power
- 3-phase general purpose
- "Relay-style" terminal arrangement (input and output terminals on opposite sides)
- Mounting on heatsink with screws

77.x5

Screw terminal (plate clamp)



* See L77-11 diagrams page 11

** See L77-8, L77-9 and L77-10 diagrams page 11

For outline drawing see page 14

Output specification

Output configuration

Rated current I_N /Max. peak current* (10 ms) A

Rated voltage V AC (50/60 Hz)

Switching voltage range V AC (50/60 Hz)

Repetitive peak off-state voltage V_{pk}

Nominal lamp rating:

230 V incandescent/halogen W

fluorescent tubes with

electronic ballast W

fluorescent tubes with

electromechanical ballast W

CFL W

230 V LED W

LV halogen or LED with

electronic ballast W

LV halogen or LED with

electromechanical ballast W

Minimum switching current @ 250 V mA

Typical "OFF-state" leakage current @ 250 V mA

Max "ON-state" voltage drop

@ 25 °C and I_N V

Power loss @ I_N W

Input specification

Nominal voltage (U_N) V AC (50/60 Hz)

V DC

Rated power @ U_{MAX} VA (50 Hz)/W

Operating range V AC (50/60 Hz)

V DC

Must drop-out voltage V AC (50/60 Hz)/DC

Technical data

Electrical life cycles

Operate/release time ms

Insulation between input and output (1.2/50 μ s) kV

Ambient temperature °C

Protection category

Approvals (according to type)

77.25.x.xxx.8650



Zero-crossing switch-on

- Output: 25 A/600 V AC
- Suggested applications: heater control

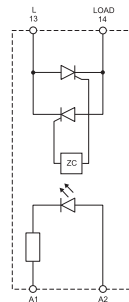

77.45.x.xxx.8650



Zero-crossing switch-on

- Output: 40 A/600 V AC
- Suggested applications: heater control

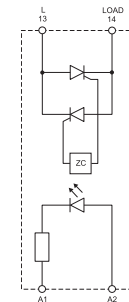

77.55.x.xxx.8650



Zero-crossing switch-on

- Output: 50 A/600 V AC
- Suggested applications: heater control

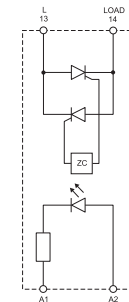

| Output specification | 77.25.x.xxx.8650 | 77.45.x.xxx.8650 | 77.55.x.xxx.8650 |
|---|----------------------|----------------------|----------------------|
| Output configuration | 1 NO (SPST-NO) | 1 NO (SPST-NO) | 1 NO (SPST-NO) |
| Rated current I_N /Max. peak current* (10 ms) A | 25/300* | 40/500* | 50/520* |
| Rated voltage V AC (50/60 Hz) | 600 | 600 | 600 |
| Switching voltage range V AC (50/60 Hz) | 43.2...660 | 43.2...660 | 43.2...660 |
| Repetitive peak off-state voltage V_{pk} | 1200 | 1200 | 1200 |
| Nominal lamp rating: | | | |
| 230 V incandescent/halogen W | 2000 | 4000 | 6000 |
| fluorescent tubes with electronic ballast W | 2000 | 4000 | 6000 |
| fluorescent tubes with electromechanical ballast W | 1000 | 2000 | 3000 |
| CFL W | 800 | 3000 | 4000 |
| 230 V LED W | 800 | 3000 | 4000 |
| LV halogen or LED with electronic ballast W | 800 | 3000 | 4000 |
| LV halogen or LED with electromechanical ballast W | 1000 | 3000 | 4000 |
| Minimum switching current @ 250 V mA | 120 | 250 | 250 |
| Typical "OFF-state" leakage current @ 250 V mA | 10 | 10 | 10 |
| Max "ON-state" voltage drop @ 25 °C and I_N V | 1.6 | 1.6 | 1.6 |
| Power loss @ I_N W | 40 | 64 | 80 |
| Input specification | | | |
| Nominal voltage (U_N) V AC (50/60 Hz) | — | 230 | 230 |
| V DC | 24 | — | 24 |
| Rated power @ U_{MAX} VA (50 Hz)/W | —/0.6 | 2.4/— | —/0.6 |
| Operating range V AC (50/60 Hz) | — | 90...280 | — |
| V DC | 4...32 | — | 4...32 |
| Must drop-out voltage V AC (50/60 Hz)/DC | —/1 | 10/— | —/1 |
| Technical data | | | |
| Electrical life cycles | 10 · 10 ⁶ | 10 · 10 ⁶ | 10 · 10 ⁶ |
| Operate/release time ms | 10/10 | 40/80 | 10/10 |
| Insulation between input and output (1.2/50 μ s) kV | 5.6 | 5.6 | 5.6 |
| Ambient temperature °C | −30...+80** | −30...+80** | −30...+80** |
| Protection category | IP 20 | IP 20 | IP 20 |
| Approvals (according to type) | | | |

Ordering information

Example: 77 series modular SSR, 1 output 30 A AC, input voltage 230 V AC, relay style terminals arrangement, zero-crossing switch-on.

7 7 . 3 1 . 8 . 2 3 0 . 8 0 5 0

A B C D

| | |
|---|--|
| <p>Series</p> <p>Type/rated current 0 = 5/7/15 A output (77.01) 1 = 15 A output (77.11) 2 = 25 A output (77.25) 3 = 30 A output (77.31) 4 = 40 A output (77.45) 5 = 50 A output (77.55)</p> <p>No. of poles/mounting 1 = 1 pole, modular housing (plastic or heat sink/plastic), DIN rail mounting 5 = 1 pole, heat-sink or directly panel mounting ("hockey puck")</p> <p>Input version 0 = DC/AC (50/60 Hz) 8 = AC (50/60 Hz) 9 = DC</p> <p>Supply voltage See "input specification"</p> | <p>D: Switch-on mode 0 = Zero-crossing 1 = Random</p> <p>C: Terminals arrangement 5 = "Relay style" (input and output on opposite sides) 7 = "Contactor style" (input and output on adjacent sides)</p> <p>AB: Output circuit (rated voltage) 80 = 230 V AC (77.01), 400 V AC (77.31) 82 = 230 V AC (77.11, 77.x5) 86 = 600 V AC (77.x5) 9024 = 24 V DC 9125 = 110...125 V DC</p> |
|---|--|

Codes/Module width

| | | | | | | | |
|--------------------------|------|--------------------------|------|--------------------------|------|------------------------------|------|
| 77.01.8.230.8050/17.5 mm | 5 A | 77.11.8.230.8250/22.5 mm | 15 A | 77.31.8.230.8050/22.5 mm | 30 A | 77.25.8.230.8250/hockey puck | 25 A |
| 77.01.0.024.8050/17.5 mm | 5 A | 77.11.9.024.8250/22.5 mm | 15 A | 77.31.9.024.8050/22.5 mm | 30 A | 77.25.9.024.8250/hockey puck | 25 A |
| 77.01.8.230.8051/17.5 mm | 5 A | 77.11.8.230.8251/22.5 mm | 15 A | 77.31.8.230.8051/22.5 mm | 30 A | 77.25.8.230.8650/hockey puck | 25 A |
| 77.01.0.024.8051/17.5 mm | 5 A | 77.11.9.024.8251/22.5 mm | 15 A | 77.31.9.024.8051/22.5 mm | 30 A | 77.25.9.024.8650/hockey puck | 25 A |
| 77.01.9.024.9125/17.5 mm | 7 A | | | 77.31.8.230.8070/22.5 mm | 30 A | 77.45.8.230.8250/hockey puck | 40 A |
| 77.01.9.024.9024/17.5 mm | 15 A | | | 77.31.9.024.8070/22.5 mm | 30 A | 77.45.9.024.8250/hockey puck | 40 A |
| | | | | 77.31.8.230.8071/22.5 mm | 30 A | 77.45.8.230.8650/hockey puck | 40 A |
| | | | | 77.31.9.024.8071/22.5 mm | 30 A | 77.45.9.024.8650/hockey puck | 40 A |
| | | | | | | 77.55.8.230.8250/hockey puck | 50 A |
| | | | | | | 77.55.9.024.8250/hockey puck | 50 A |
| | | | | | | 77.55.8.230.8650/hockey puck | 50 A |
| | | | | | | 77.55.9.024.8650/hockey puck | 50 A |

Technical data

| | | 77.01.8xxx | | 77.01.9xxx | | 77.11 | | 77.31 | | 72.25/45/55 | | | |
|---|------------------------|---------------------|---------------------|---------------------|---------------------|---------------------|---------------------|---------------------|---------------------|--------------------------|---------------------|--------------------|--|
| | | Dielectric strength | Impulse (1.2/50 µs) | Dielectric strength | Impulse (1.2/50 µs) | Dielectric strength | Impulse (1.2/50 µs) | Dielectric strength | Impulse (1.2/50 µs) | Dielectric strength | Impulse (1.2/50 µs) | | |
| Between input and output | | 2500 V AC | 5 kV | 3000 V AC | 4 kV | 3000 V AC | 6 kV | 3000 V AC | 6 kV | 4000 V AC | 5.6 kV | | |
| Between input and ground (heat-sink) | | — | — | — | — | 3000 V AC | 6 kV | 3000 V AC | 6 kV | 4000 V AC | 5.6 kV | | |
| Between output and ground (heat-sink) | | — | — | — | — | 2500 V AC | 4 kV | 4000 V AC | 6 kV | 4000 V AC | 5.6 kV | | |
| EMC specifications | | Reference standard | | 77.01.8xxx | | 77.01.9xxx | | 77.11 | | 77.31 | | 72.25/45/55 | |
| | | | | 24 V AC/DC | 230 V AC | 24 V DC | 24 V AC/DC | 230 V AC | 24 V AC/DC | 230 V AC | 24 V AC/DC | - 230 V AC | |
| Electrostatic discharge | contact discharge | EN 61000-4-2 | | 4 kV | 4 kV | 4 kV | 4 kV | 4 kV | 4 kV | 4 kV | 4 kV | | |
| | air discharge | EN 61000-4-2 | | 8 kV | 8 kV | 8 kV | 8 kV | 8 kV | 8 kV | 8 kV | 8 kV | | |
| Radiated electromagnetic field (80...1000 MHz) | | EN 61000-4-3 | | 30 V/m | — | 20 V/m | 30 V/m | — | — | — | | | |
| Fast transients on supply terminals (burst 5/50 ns, 5 and 100 kHz) | | EN 61000-4-4 | | 1 kV | 4 kV | 2 kV | 1 kV | 3 kV | 1 kV | 3 kV | 2 kV | | |
| Voltage pulses on supply terminals (surge 1.2/50 µs) | common mode | EN 61000-4-5 | | 2 kV | 4 kV | 1 kV | 3 kV | 3 kV | 3 kV | 3 kV | 2 kV | | |
| | differential mode | EN 61000-4-5 | | 1 kV | 4 kV | 0.5 kV | 0.5 kV | 1.5 kV | 0.5 kV | 1.5 kV | 1 kV | | |
| Radio-frequency common mode voltage (0.15...230 MHz) on supply terminals | | EN 61000-4-6 | | — | 10 V | 10 V | 10 V | 10 V | — | | | | |
| Terminals | | 77.01.8xxx | | 77.01.9xxx | | 77.11 | | 77.31 | | 72.25/45/55 | | | |
| | | | | | | | | | | Input | Output | | |
|  Screw torque | Nm | 0.8 | | 0.8 | | 0.8 | | 0.8 | | 0.5 | 1.2 | | |
| Max. wire size | mm ² | solid cable | stranded cable | solid cable | stranded cable | solid cable | stranded cable | solid cable | stranded cable | solid and stranded cable | | | |
| | | 1 x 6/ 2 x 4 | 1 x 4/ 2 x 25 | 1 x 6/ 2 x 4 | 1 x 4/ 2 x 25 | 1 x 6/ 2 x 4 | 1 x 6/ 2 x 4 | 1 x 6/ 2 x 4 | 1 x 6/ 2 x 4 | 1 (with ferrule) | 4 (with ferrule) | 10 (with fork tip) | |
| Wire strip length | mm | AWG | 1 x 10/ 2 x 12 | 1 x 12/ 2 x 14 | 1 x 10/ 2 x 12 | 1 x 12/ 2 x 14 | 1 x 10/ 2 x 12 | 1 x 10/ 2 x 12 | 1 x 10/ 2 x 12 | 18 (with ferrule) | 12 (with ferrule) | 8 (with fork tip) | |
| | | 9 | 9 | 9 | 9 | 10 | 10 | | | | | | |
| Other data | | | | | | | | | | | | | |
| Power lost to the environment | without output current | W | 0.5 | 0.5 | 0.9 | 0.9 | 0.6 | | | | | | |
| | with rated current | W | 4.0 | 4.0 | 14 | 16 | 40/64/80 | | | | | | |

Input specification

77.01

| Nominal voltage | Input code | Operating range | | | | Must drop-out voltage (AC/DC) | Input current I_N at U_N |
|-----------------|--------------|-----------------|-----------|-----------|-----------|-------------------------------|---------------------------------|
| | | AC | | DC | | | |
| | | U_{min} | U_{max} | U_{min} | U_{max} | | |
| U_N | | V | V | V | V | V | mA |
| 24 | 0.024 | 16 | 32 | 9.8 | 32 | 2.4 | 25 |
| 24 | 9.024 | — | — | 4 | 32 | 3.0 | 18 |
| 230 | 8.230 | 90 | 265 | — | — | 24 | 15 |

77.11

| Nominal voltage | Input code | Operating range | | | | Must drop-out voltage (AC/DC) | Input current I_N at U_N |
|-----------------|--------------|-----------------|-----------|-----------|-----------|-------------------------------|---------------------------------|
| | | AC | | DC | | | |
| | | U_{min} | U_{max} | U_{min} | U_{max} | | |
| U_N | | V | V | V | V | V | mA |
| 24 | 9.024 | — | — | 4 | 32 | 2 | 11 |
| 230 | 8.230 | 40 | 305 | — | — | 6 | 25 |

77.31

| Nominal voltage | Input code | Operating range | | | | Must drop-out voltage (AC/DC) | Input current I_N at U_N |
|-----------------|--------------|-----------------|-----------|-----------|-----------|-------------------------------|---------------------------------|
| | | AC | | DC | | | |
| | | U_{min} | U_{max} | U_{min} | U_{max} | | |
| U_N | | V | V | V | V | V | mA |
| 24 | 9.024 | — | — | 4 | 32 | 2 | 11 |
| 230 | 8.230 | 40 | 280 | — | — | 6 | 25 |

77.x5.x.xxx.8250

| Nominal voltage | Input code | Operating range | | | | Must drop-out voltage (AC/DC) | Input current I_N at U_N |
|-----------------|--------------|-----------------|-----------|-----------|-----------|-------------------------------|---------------------------------|
| | | AC | | DC | | | |
| | | U_{min} | U_{max} | U_{min} | U_{max} | | |
| U_N | | V | V | V | V | V | mA |
| 24 | 9.024 | — | — | 3 | 32 | 1 | 22 |
| 230 | 8.230 | 90 | 280 | — | — | 10 | 20 |

77.x5.x.xxx.8650

| Nominal voltage | Input code | Operating range | | | | Must drop-out voltage (AC/DC) | Input current I_N at U_N |
|-----------------|--------------|-----------------|-----------|-----------|-----------|-------------------------------|---------------------------------|
| | | AC | | DC | | | |
| | | U_{min} | U_{max} | U_{min} | U_{max} | | |
| U_N | | V | V | V | V | V | mA |
| 24 | 9.024 | — | — | 4 | 32 | 1 | 25 |
| 230 | 8.230 | 90 | 280 | — | — | 10 | 10 |

Led indication

| LED | Supply voltage |
|-----|----------------|
| | OFF |
| | ON |

| LED (77.01.9.024.9xxx only) | Short circuit* |
|-----------------------------|----------------|
| | NO |
| | YES |

* To restore normal operation it is necessary to disconnect the power, resolve the short circuit and then restore power.

D

Output specification

L77-1 Output RMS current v ambient temperature
77.01.0.024.805x @ 32 V DC

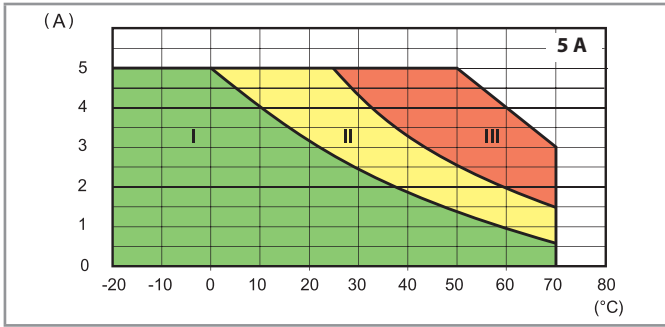

L77-2 Output RMS current v ambient temperature
77.01.8.230.805x @ 265 V AC

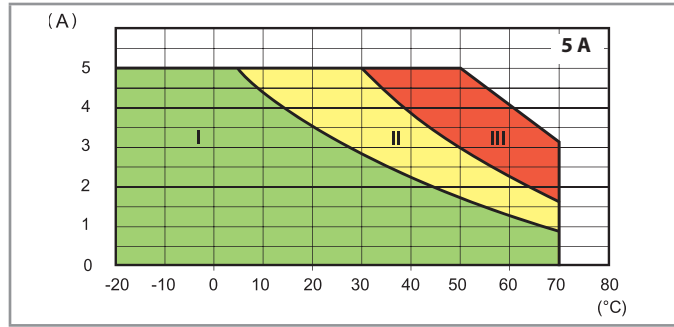

D

- I - Modular SSR installed as a group (without gap)
- II - Modular SSR installed as a group (9 mm gap between each SSR)
- III - Modular SSR installed individually in free air (without a significant influence from nearby components)

L77-12 Output DC current v ambient temperature
77.01.9.024.9024 @ 32 V DC

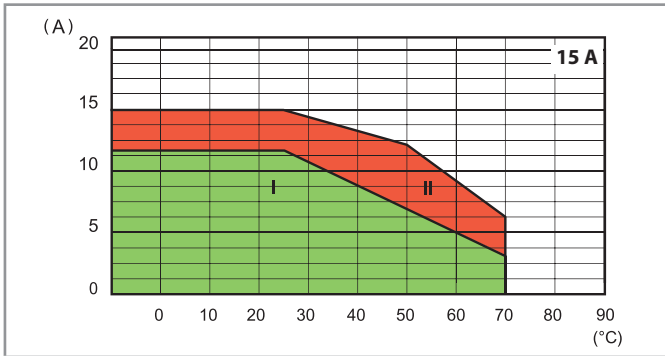

- I - Modular SSR installed as a group (without gap)
- II - Modular SSR installed individually in free air, or with a gap ≥ 9 mm, which implies a not significant influence from nearby components

L77-13 Output DC current v ambient temperature
77.01.9.024.9125 @ 32 V DC

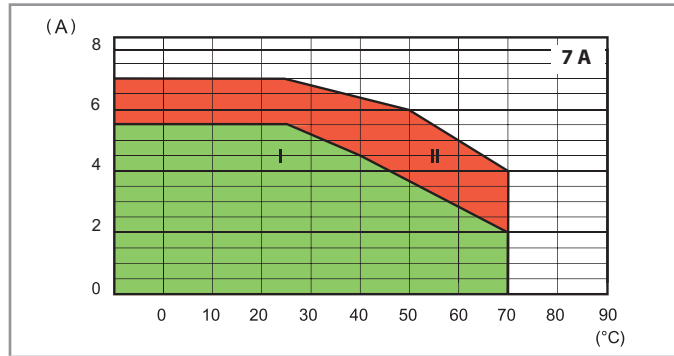

L77-6 Output RMS current v ambient temperature
77.11.x.xxx.82xx

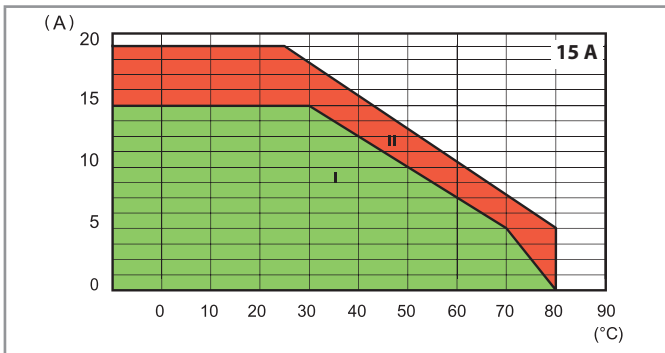

- I - Modular SSR installed as a group (without gap)
- II - Modular SSR installed individually in free air, or with a gap ≥ 20 mm, which implies a not significant influence from nearby components

L77-4 Output RMS current v ambient temperature
77.31.x.xxx.80xx

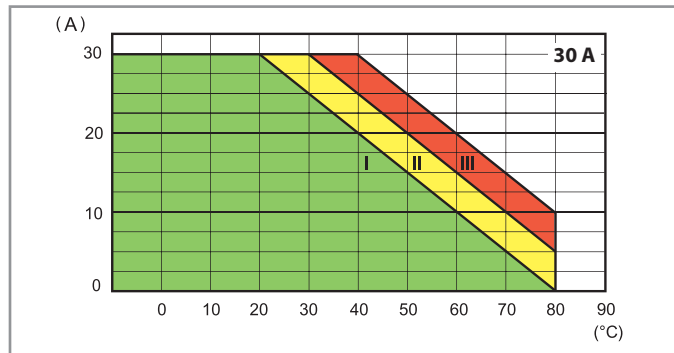

- I - Modular SSR installed as a group (without gap)
- II - Modular SSR installed as a group (20 mm gap between each SSR)
- III - Modular SSR installed individually in free air, or with a gap ≥ 40 mm, which implies a not significant influence from nearby components)

Output specification

L77-10 Output RMS current v ambient temperature
77.25.x.xxx.8x50

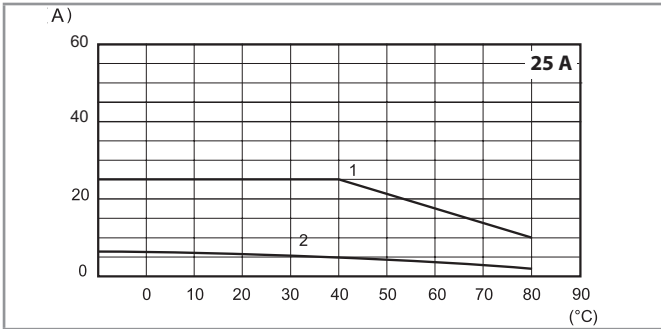

- 1 - Installation on 077.25 heat-sink (2 K/W)
- 2 - Installation individually in free-air

L77-9 Output RMS current v ambient temperature
77.45.x.xxx.8x50

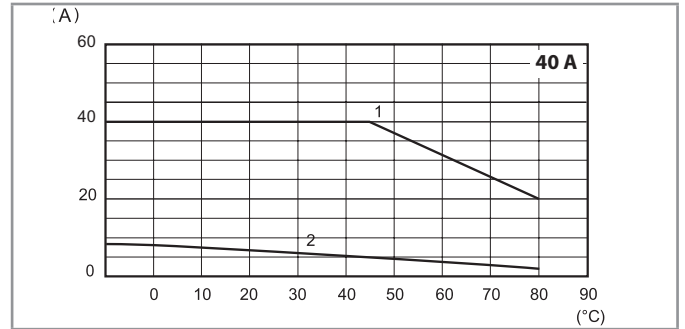

- 1 - Installation on 077.55 heat-sink (0.9 K/W)
- 2 - Installation individually in free-air

L77-8 Output RMS current v ambient temperature
77.55.x.xxx.8x50

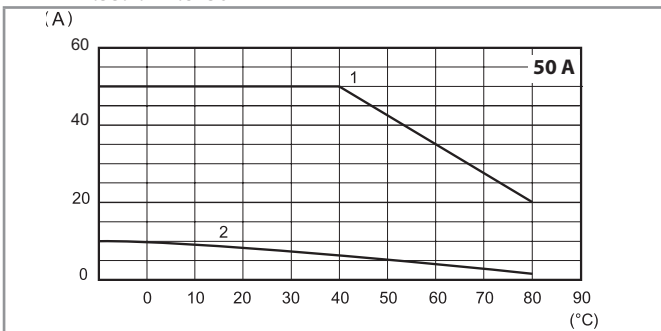

- 1 - Installation on 077.55 heat-sink (0.9 K/W)
- 2 - Installation individually in free-air

L77-3 Inrush peak current (AC) v inrush time
77.01.x.xxx.80xx

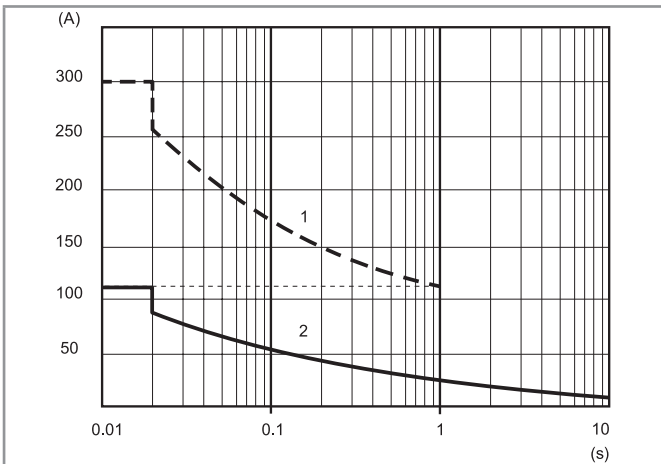

L77-7 Inrush peak current (AC) v inrush time
77.11.x.xxx.82xx

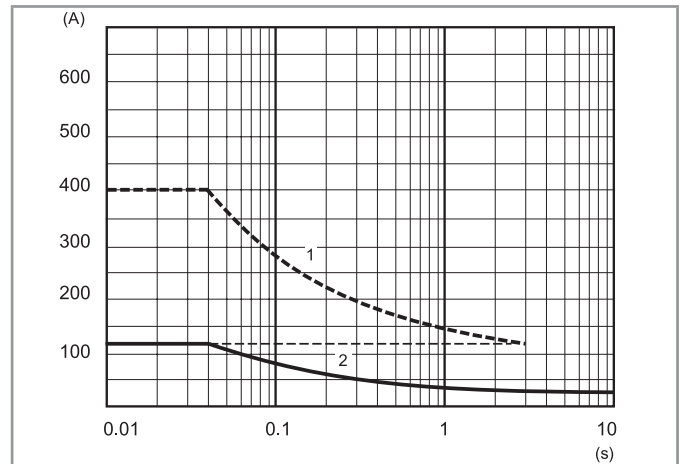

L77-5 Inrush peak current (AC) v inrush time
77.31.x.xxx.80xx

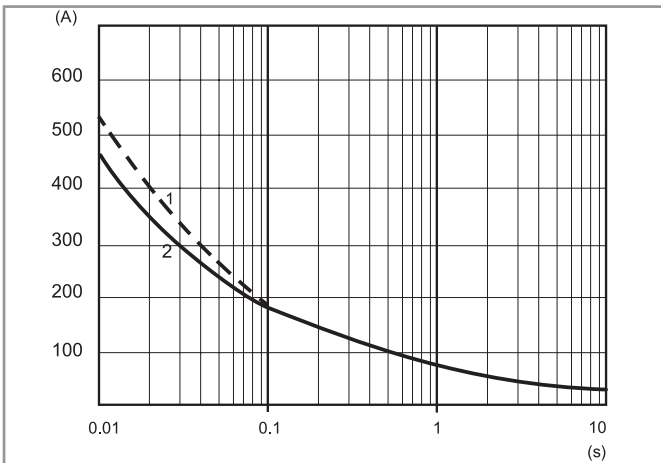

L77-11 Inrush peak current (AC) v inrush time
77x5.x.xxx.8x50

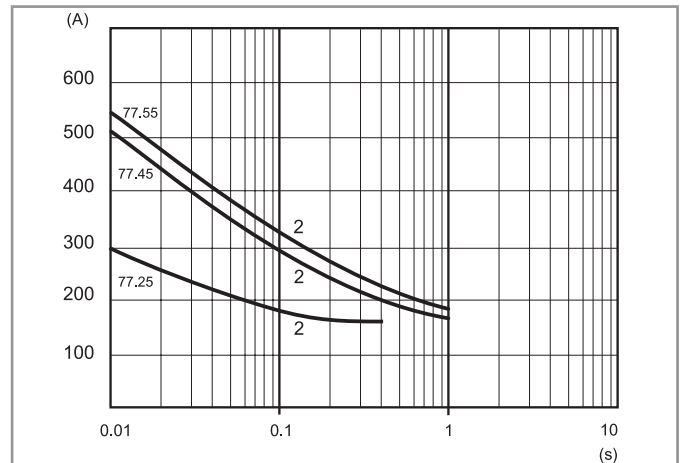

- 1 - "Cold" conditions (ambient temperature = 23 °C, no output current during the last 15 minutes)
- 2 - "Hot" conditions (ambient temperature = 50 °C, rated output current)

Output specification

| Max recommended switching frequency (Cycles/Hour, with 50% Duty-cycle) | | | | | | | |
|--|------------|------------|-------|-------|-------|-------|-------|
| Load | 77.01.8xxx | 77.01.9xxx | 77.11 | 77.31 | 77.25 | 77.45 | 77.55 |
| 5 A 230 V (AC1) | 5000 | — | — | — | — | — | — |
| 5 A 24 V DC L/R = 20 ms | — | 3600 | — | — | — | — | — |
| 1 A (AC15) | 10000 | — | — | — | — | — | — |
| 0.5 A (AC15) | 20000 | — | — | — | — | — | — |
| 15 A 305 V $\cos \varphi = 0.8$ | — | — | 1800 | — | — | — | — |
| 15 A 305 V $\cos \varphi = 0.5$ | — | — | 1200 | — | — | — | — |
| 30 A 480 V $\cos \varphi = 0.8$ | — | — | — | 1800 | — | — | — |
| 30 A 480 V $\cos \varphi = 0.5$ | — | — | — | 1200 | — | — | — |
| 25 A 230 V $\cos \varphi = 0.7$ | — | — | — | — | 1800 | — | — |
| 40 A 230 V $\cos \varphi = 0.7$ | — | — | — | — | — | 1800 | — |
| 50 A 230 V $\cos \varphi = 0.7$ | — | — | — | — | — | — | 1800 |

| Other data | | | | | | | |
|---|-------------------------|-------------------------|--|-------------------------|--|---|--|
| | 77.01.8xxx | 77.01.9xxx | 77.11 | 77.31 | 77.25 | 77.45 | 77.55 |
| Critical rising voltage dv/dt without input control (gate open) @ $T_j = 125^\circ\text{C}$ | > 1000 V/ μs | > 1000 V/ μs | > 500 V/ μs > 10 V/ μs (with di/dt = 20 A/ms) | > 1000 V/ μs | 300 V/ μs (.8250) 500 V/ μs (.8650) | 500 V/ μs (.8250) 1000 V/ μs (.8650) | 1000 V/ μs (.8250) 1000 V/ μs (.8650) |
| Critical rising current di/dt @ $T_j = 125^\circ\text{C}$ | > 50 A/ μs | > 50 A/ μs | > 50 A/ μs | > 150 A/ μs | — | — | — |
| I²t for fusing @ $t_p = 10\text{ ms}$ | 450 A ² s | 450 A ² s | 1000 A ² s* | 1350 A ² s** | 450 A ² s | 1250 A ² s | 1350 A ² s |

Suggested fuse (depending on application) for short-circuit protection (Ultra-Fast acting types for semiconductors):

* 20 A, 660 V AC, 10 x 38 mm, 200 kA, 360 A²s.

** 30 A, 660 V AC, 10 x 38 mm, 200 kA, 1000 A²s.

Wiring diagrams

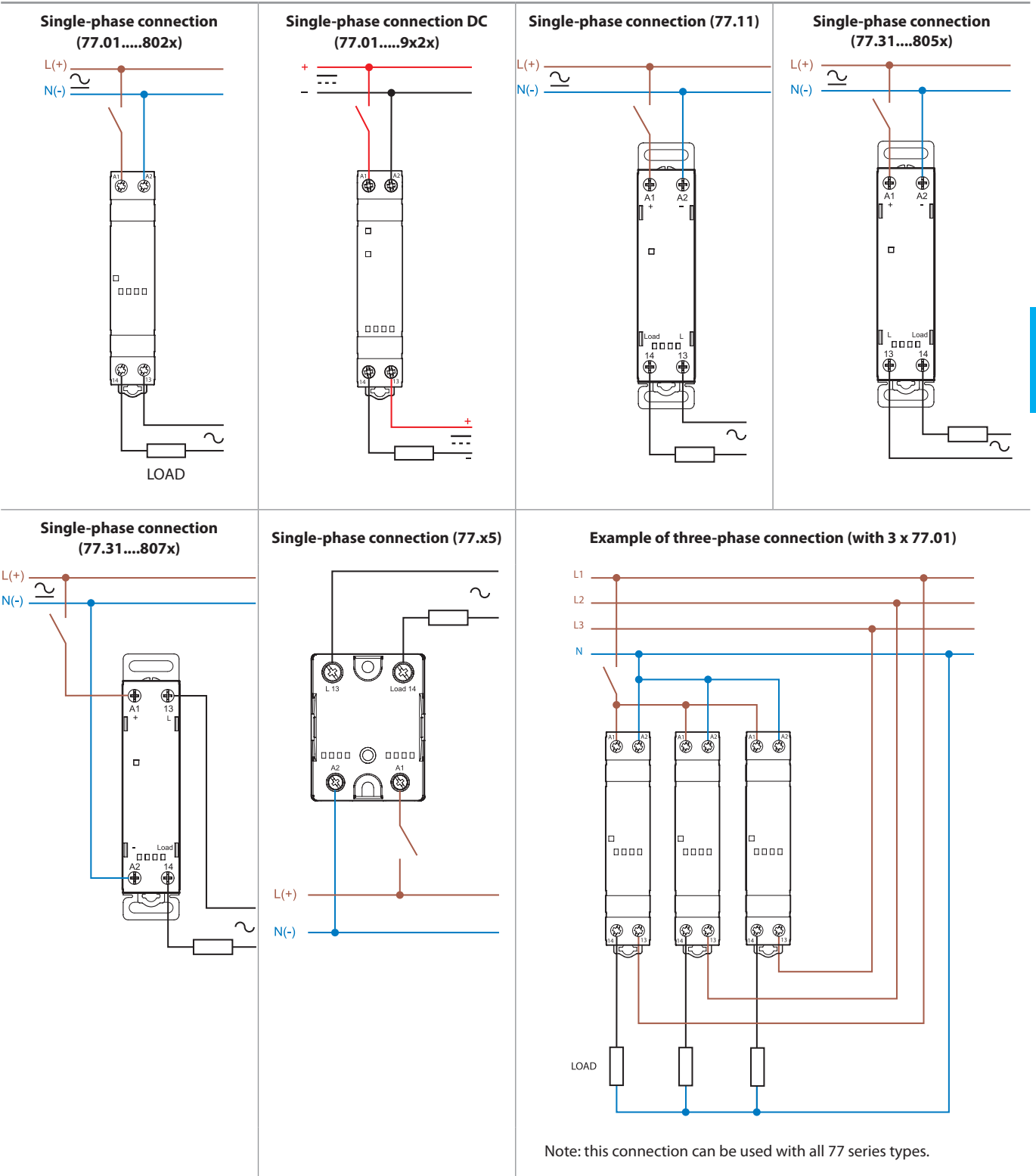

Outline drawings

77.01
Screw terminal

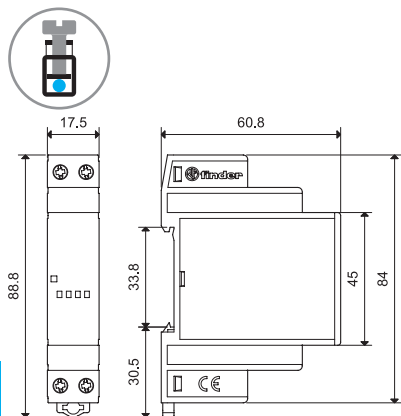

77.11/31
Screw terminal

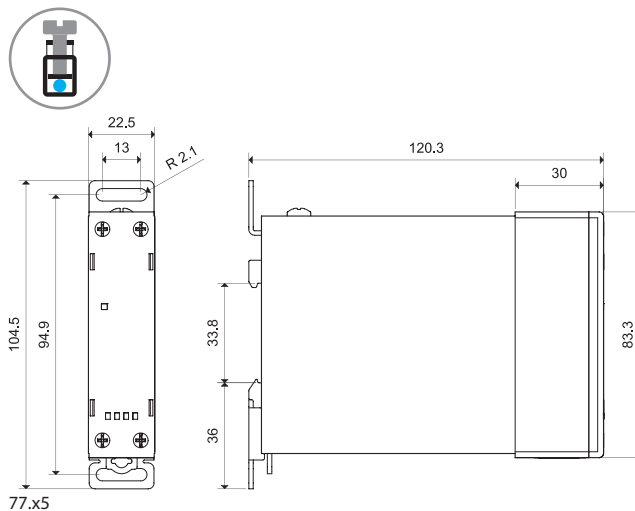

77.01 DC
Screw terminal

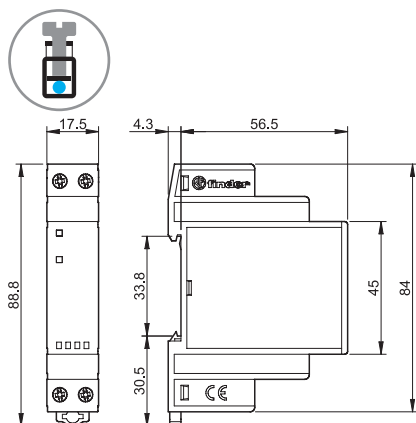

77.x5
Screw terminal (plate clamp)

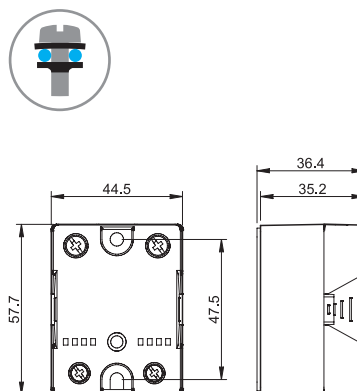

Accessories



Adaptor for panel mounting, plastic, 17.5 mm wide for 77.01 only

020.01

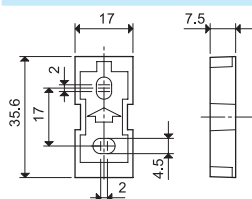

Separator for rail mounting, plastic, 9 mm wide

022.09

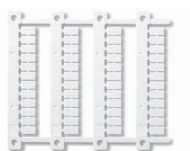
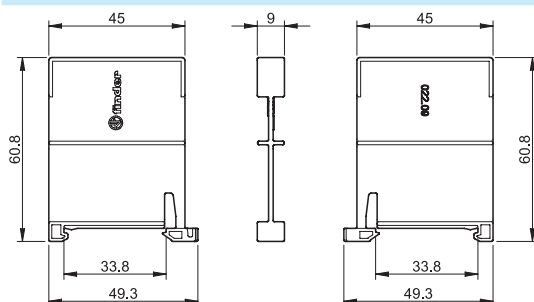

Sheet of marker tags (CEMBRE Thermal transfer printers) for all relays
(48 tags), 6 x 12 mm

060.48

060.48

Accessories



077.25

Heat-sink, anodized aluminium, 2 K/W, 65 x 100 mm, for 77.25 only

077.25

- Both the SSR and 35 mm rail clip mount to the heat-sink using M4 screws (supplied with heat-sink)
- Before assembling to the heat-sink, it is necessary to apply a thin and even layer of thermal conductive paste (not supplied) to the lower metal surface of the SSR

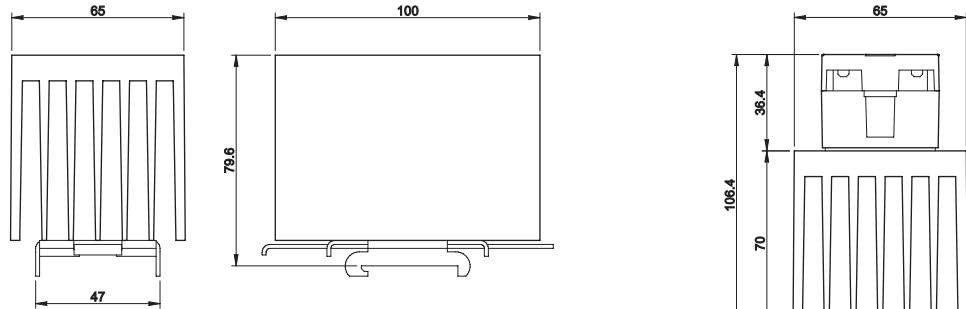

077.25 with 77.25

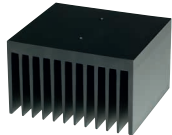

077.55

Heat-sink, anodized aluminium, 0,9 K/W, 111 x 100 mm, for 77.45 and 77.55

077.55

- Both the SSR and 35 mm rail clip mount to the heat-sink using M4 screws (supplied with heat-sink)
- Before assembling to the heat-sink, it is necessary to apply a thin and even layer of thermal conductive paste (not supplied) to the lower metal surface of the SSR

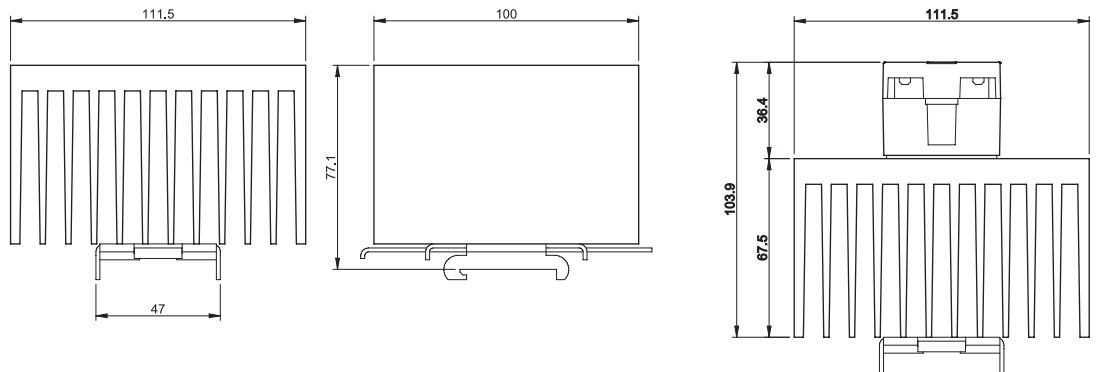

077.55 with 77.45/55

D

