

**1 & 2 CO industrial style power relays**  
**For socket mount or direct connection via**  
**Faston connectors**

**Type 46.52**

- 2 CO 8 A

**Type 46.61**

- 1 CO 16 A

- AC coils & DC coils
- Available with: lockable test button, mechanical indicator & LED indicator
- 8 mm, 6 kV (1.2/50 µs) isolation, coil-contacts
- Cadmium free contacts
- 97 series 35 mm rail (EN 60715) Screw, Screwless or Push-in terminals, and PCB mount sockets
- Coil Indication and EMC suppression modules 99 series and Timer module 86.30 options
- Optional alternative mounting adaptors
- European Patent

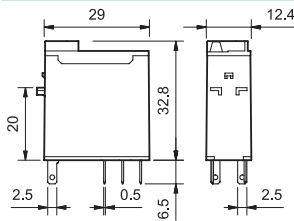

46.52

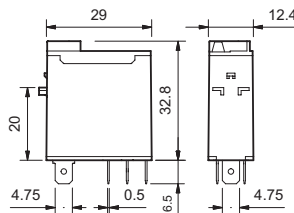

46.61

FOR UL RATINGS SEE:

"General technical information" page V

46.52

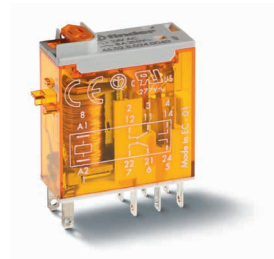

- 2 CO 8 A
- Plug-in/Solder terminals

46.61

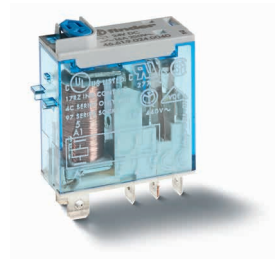

- 1 CO 16 A
- Plug-in/Faston 187

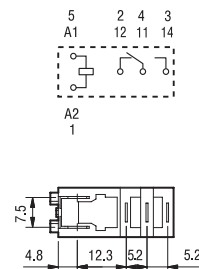
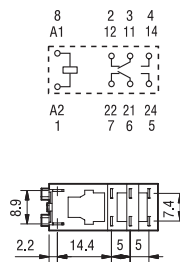

**Contact specification**

|   |           |             |             |
|---|-----------|-------------|-------------|
| Contact configuration                   |           | 2 CO (DPDT) | 1 CO (SPDT) |
| Rated current/Maximum peak current      | A         | 8/15        | 16/25*      |
| Rated voltage/Maximum switching voltage | V AC      | 250/440     | 250/440     |
| Rated load AC1                          | VA        | 2000        | 4000        |
| Rated load AC15 (230 V AC)              | VA        | 350         | 750         |
| Single phase motor rating (230 V AC)    | kW        | 0.37        | 0.55        |
| Breaking capacity DC1: 30/110/220 V     | A         | 6/0.5/0.15  | 12/0.5/0.15 |
| Minimum switching load                  | mW (V/mA) | 300 (5/5)   | 300 (5/5)   |
| Standard contact material               |           | AgNi        | AgNi        |

\* With the AgSnO<sub>2</sub> material the maximum peak current is 80 A - 5 ms on normally open contact.

**Coil specification**

|                                   |                 |   |
|-----------------------------------|-----------------|---|
| Nominal voltage (U <sub>N</sub> ) | V AC (50/60 Hz) | 12 - 24 - 48 - 110 - 120 - 230 - 240    |
|                                   | V DC            | 12 - 24 - 48 - 110 - 125                |
| Rated power                       | VA/W            | 1.2/0.5                                 |
| Operating range                   | AC              | (0.8...1.1)U <sub>N</sub>               |
|                                   | DC              | (0.73...1.1)U <sub>N</sub>              |
| Holding voltage                   | AC/DC           | 0.8 U <sub>N</sub> / 0.4 U <sub>N</sub> |
| Must drop-out voltage             | AC/DC           | 0.2 U <sub>N</sub> / 0.1 U <sub>N</sub> |

**Technical data**

|  |        |                       |                       |
|--|--------|-----------------------|-----------------------|
| Mechanical life AC/DC                            | cycles | 10 · 10 <sup>6</sup>  | 10 · 10 <sup>6</sup>  |
| Electrical life at rated load AC1                | cycles | 100 · 10 <sup>3</sup> | 100 · 10 <sup>3</sup> |
| Operate/release time                             | ms     | 10/3                  | 15/5                  |
| Insulation between coil and contacts (1.2/50 µs) | kV     | 6 (8 mm)              | 6 (8 mm)              |
| Dielectric strength between open contacts        | V AC   | 1000                  | 1000                  |
| Ambient temperature range                        | °C     | -40...+70             | -40...+70             |
| Environmental protection                         |        | RT II                 | RT II                 |

**Approvals** (according to type)



## Ordering information

Example: 46 series Miniature industrial relay, 1 CO, 24 V DC coil, lockable test button and mechanical indicator.

A

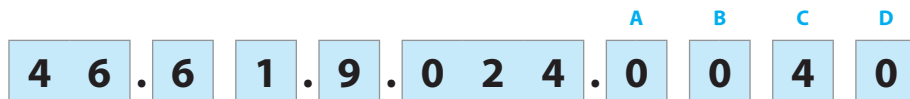

**Series** —————

**Type** —————  
5 = Spade/blade solder terminal (2.5 x 0.5)mm  
6 = Spade/blade terminal Faston 187 (4.8 x 0.5)mm

**No. of poles** —————  
1 = 1 pole, 16 A  
2 = 2 poles, 8 A

**Coil version** —————  
9 = DC  
8 = AC (50/60 Hz)

**Coil voltage** —————  
See coil specifications

**A: Contact material**  
0 = AgNi  
4 = AgSnO<sub>2</sub> (46.61 only)  
5 = AgNi + Au

**B: Contact circuit**  
0 = CO (nPDT)

**D: Special versions**  
0 = Standard

**C: Options**  
2 = Mechanical indicator  
4 = Lockable test button + mechanical indicator  
54 = Lockable test button + LED (AC) + mechanical indicator  
74 = Lockable test button + double LED (DC non-polarized) + mechanical indicator

**Selecting features and options: only combinations in the same row are possible.**  
Preferred selections for best availability are shown in **bold**.

| Type  | Coil version | A                | B        | C            | D        |
|-------|--------------|------------------|----------|--------------|----------|
| 46.52 | AC - DC      | <b>0 - 5</b>     | <b>0</b> | <b>2 - 4</b> | <b>0</b> |
|       | AC           | 0 - 5            | 0        | 54           | /        |
|       | DC           | 0 - 5            | 0        | 74           | /        |
| 46.61 | AC - DC      | <b>0 - 4 - 5</b> | <b>0</b> | <b>2 - 4</b> | <b>0</b> |
|       | AC           | 0 - 4 - 5        | 0        | 54           | /        |
|       | DC           | 0 - 4 - 5        | 0        | 74           | /        |

**Special versions for Rail Applications on request**

## Descriptions: Options

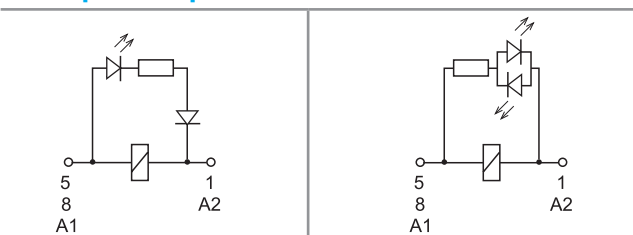

**C: Option 54**  
LED (AC)

**C: Option 74**  
LED (DC, non-polarized)

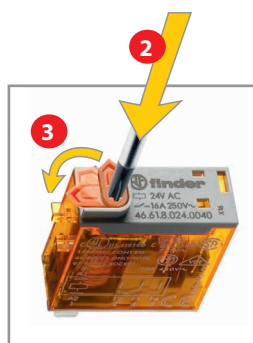

### Lockable test button and mechanical flag indicator (0040, 0054, 0074)

The dual-purpose Finder test button can be used in two ways:

Case 1) The plastic pip (located directly below the test button) remains intact. In this case, when the test button is pushed, the contacts operate. When the test button is released the contacts return to their former state.

Case 2) The plastic pip is broken-off (using an appropriate cutting tool). In this case, (in addition to the above function), when the test button is pushed and rotated, the contacts are latched in the operating state, and remain so until the test button is rotated back to its former position.

In both cases ensure that the test button actuation is swift and decisive.



**Technical data**

| Insulation according to EN 61810-1   |                         | 1 pole              |     | 2 pole              |     |
|--|-------------------------|---------------------|-----|---------------------|-----|
| Nominal voltage of supply system   | V AC                    | 230/400             |     | 230/400             |     |
| Rated insulation voltage   | V AC                    | 250                 | 400 | 250                 | 400 |
| Pollution degree   |                         | 3                   | 2   | 3                   | 2   |
| <b>Insulation between coil and contact set</b>                             |                         |                     |     |                     |     |
| Type of Insulation   |                         | Reinforced (8 mm)   |     | Reinforced (8 mm)   |     |
| Overvoltage category   |                         | III                 |     | III                 |     |
| Rated impulse voltage  | kV (1.2/50 μs)          | 6                   |     | 6                   |     |
| Dielectric strength  | V AC                    | 4000                |     | 4000                |     |
| <b>Insulation between adjacent contacts</b>                                |                         |                     |     |                     |     |
| Type of insulation   |                         | —                   |     | Basic               |     |
| Overvoltage category   |                         | —                   |     | III                 |     |
| Rated impulse voltage  | kV (1.2/50 μs)          | —                   |     | 4                   |     |
| Dielectric strength  | V AC                    | —                   |     | 2000                |     |
| <b>Insulation between open contacts</b>                                    |                         |                     |     |                     |     |
| Type of disconnection  |                         | Micro-disconnection |     | Micro-disconnection |     |
| Dielectric strength  | V AC/kV (1.2/50 μs)     | 1000/1.5            |     | 1000/1.5            |     |
| <b>Conducted disturbance immunity</b>                                      |                         |                     |     |                     |     |
| Burst (5...50)ns, 5 kHz, on A1 - A2 according to EN 61000-4-4              |                         | level 4 (4 kV)      |     |                     |     |
| Surge (1.2/50 μs) on A1 - A2 (differential mode) according to EN 61000-4-5 |                         | level 3 (2 kV)      |     |                     |     |
| <b>Other data</b>  |                         | <b>46.61</b>        |     | <b>46.52</b>        |     |
| Bounce time: NO/NC   | ms                      | 2/6                 |     | 1/4                 |     |
| Vibration resistance (10...150)Hz: NO/NC                                   | g                       | 20/12               |     | 20/15               |     |
| Shock resistance   | g                       | 20                  |     | 20                  |     |
| Power lost to the environment  | without contact current | W                   | 0.6 |                     | 0.6 |
|  | with rated current      | W                   | 1.6 |                     | 2   |
| Recommended distance between relays mounted on PCB                         | mm                      | ≥ 5                 |     |                     |     |

**Contact specification**

**F 46 - Electrical life (AC) v contact current**

Type 46.52

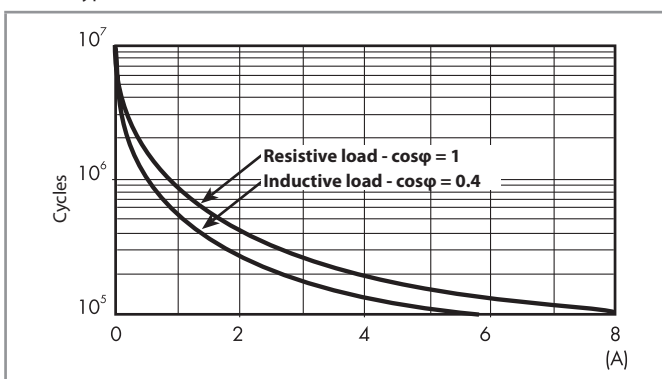

**F 46 - Electrical life (AC) v contact current**

Type 46.61

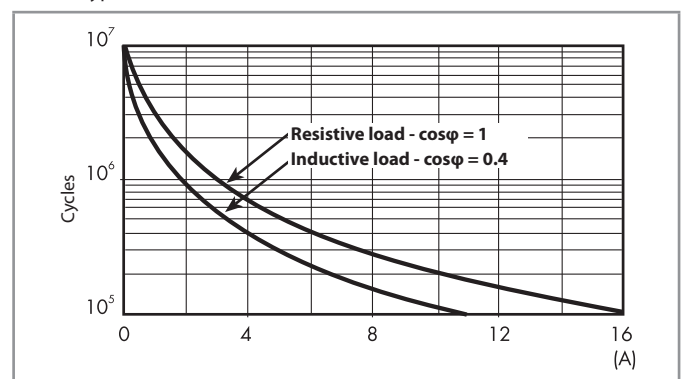

**H 46 - Maximum DC1 breaking capacity**

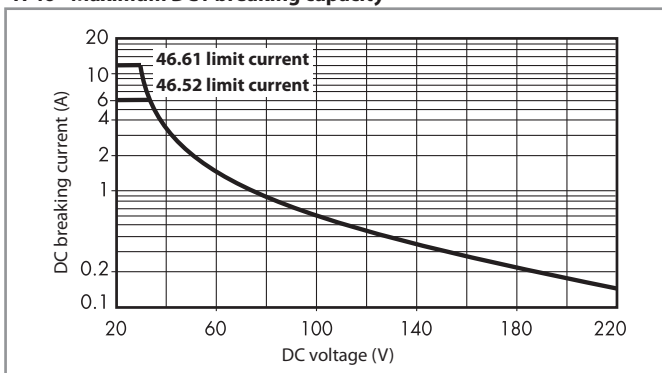

- When switching a resistive load (DC1) having voltage and current values under the curve, an electrical life of  $\geq 100 \cdot 10^3$  can be expected.
  - In the case of DC13 loads, the connection of a diode in parallel with the load will permit a similar electrical life as for a DC1 load.
- Note: the release time for the load will be increased.

## Coil specifications

A

### DC coil data

| Nominal voltage<br>$U_N$<br>V | Coil code | Operating range |                | Resistance<br>R<br>$\Omega$ | Rated coil consumption<br>I at $U_N$<br>mA |
|-------------------------------|-----------|-----------------|----------------|-----------------------------|--|
|                               |           | $U_{min}$<br>V  | $U_{max}$<br>V |                             |  |
| 12                            | 9.012     | 8.8             | 13.2           | 300                         | 40   |
| 24                            | 9.024     | 17.5            | 26.4           | 1200                        | 20   |
| 48                            | 9.048     | 35              | 52.8           | 4800                        | 10   |
| 110                           | 9.110     | 80              | 121            | 23500                       | 4.7  |
| 125                           | 9.125     | 91.2            | 138            | 32000                       | 3.9  |

### AC coil data

| Nominal voltage<br>$U_N$<br>V | Coil code | Operating range |                | Resistance<br>R<br>$\Omega$ | Rated coil consumption<br>I at $U_N$<br>mA |
|-------------------------------|-----------|-----------------|----------------|-----------------------------|--|
|                               |           | $U_{min}$<br>V  | $U_{max}$<br>V |                             |  |
| 12                            | 8.012     | 9.6             | 13.2           | 80                          | 90   |
| 24                            | 8.024     | 19.2            | 26.4           | 320                         | 45   |
| 48                            | 8.048     | 38.4            | 52.8           | 1350                        | 21   |
| 110                           | 8.110     | 88              | 121            | 6900                        | 9.4  |
| 120                           | 8.120     | 96              | 132            | 9000                        | 8.4  |
| 230                           | 8.230     | 184             | 253            | 28000                       | 5  |
| 240                           | 8.240     | 192             | 264            | 31500                       | 4.1  |

R 46 - DC coil operating range v ambient temperature

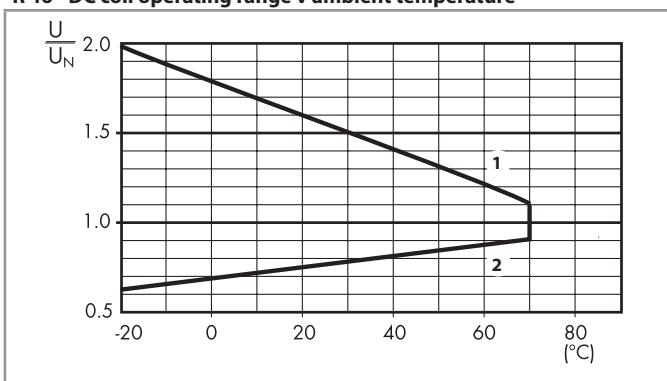

- 1 - Max. permitted coil voltage.
- 2 - Min. pick-up voltage with coil at ambient temperature.

R 46 - AC coil operating range v ambient temperature

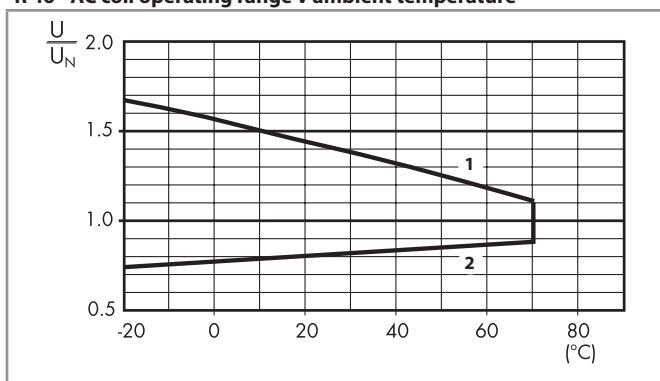

- 1 - Max. permitted coil voltage.
- 2 - Min. pick-up voltage with coil at ambient temperature.

**Accessories**



**046.05**

**Flange mount adaptor** for relays types 46.52 and 46.61

046.05

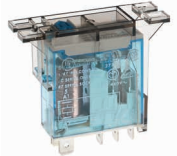

**046.05 with relay**

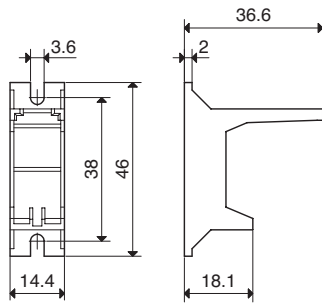

046.05

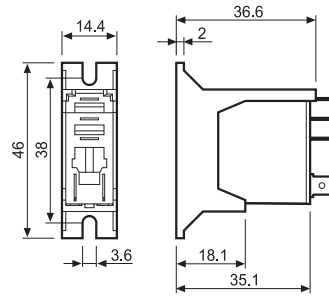

046.05 with relay



**046.07**

**35 mm rail adaptor** for relays types 46.52 and 46.61

046.07

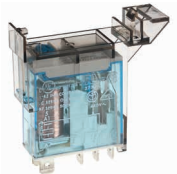

**046.07 with relay**

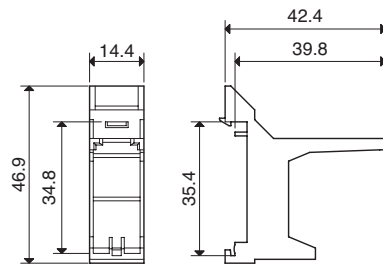

046.07

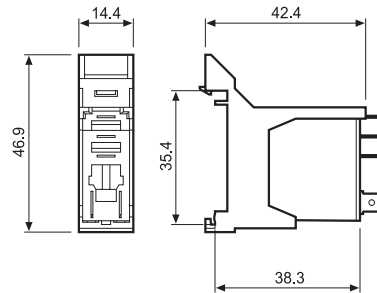

046.07 with relay

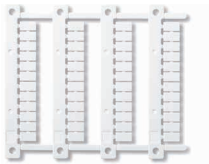

**060.48**

**Sheet of marker tags (CEMBRE Thermal transfer printers)** for relays types 46.52 and 46.61 (48 tags), 6 x 12 mm

060.48

**A**

A



97.P2

Approvals  
(according to type):



097.01

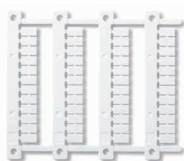

060.48

|  |  |                   |
|--|--|-------------------|
| <b>Push-in terminal socket</b> panel or 35 mm rail (EN 60715) mount  | <b>97.P1</b>                               | <b>97.P2</b>      |
| For relay type   | 46.61                                      | 46.52             |
| <b>Accessories</b>   |  |                   |
| Plastic retaining and release clip<br>(supplied with socket - packaging code SPA)                              |  | 097.01            |
| Metal retaining clip   |  | 097.71            |
| Identification tag   |  | 095.00.4          |
| 8-way jumper link  |  | 097.58            |
| 2-way jumper link  |  | 097.52            |
| 2-way jumper link  |  | 097.42            |
| Marker tag holder  |  | 097.00            |
| Modules (see table below)  |  | 99.02             |
| Timer modules (see table below)  |  | 86.30             |
| Sheet of marker tags for marker tag holder 097.00, 48 tags,<br>6 x 12 mm, for CEMBRE thermal transfer printers |  | 060.48            |
| <b>Technical data</b>  |  |                   |
| Rated values   | 10 A-250 V AC                              | 8 A-250 V AC      |
| Dielectric strength  | 6 kV (1.2/50 μs) between coil and contacts |                   |
| Protection category  | IP 20                                      |                   |
| Ambient temperature  | °C -40...+70                               |                   |
| Wire strip length  | mm 8                                       |                   |
| Min. wire size for 97.P1 and 97.P2 socket  | solid wire                                 | stranded wire     |
|  | mm <sup>2</sup> 0.5                        | 0.5               |
|  | AWG 21                                     | 21                |
| Max. wire size for 97.P1 and 97.P2 socket  | solid wire                                 | stranded wire     |
|  | mm <sup>2</sup> 2 x 1.5 / 1 x 2.5          | 2 x 1.5 / 1 x 2.5 |
|  | AWG 2 x 16 / 1 x 14                        | 2 x 16 / 1 x 14   |

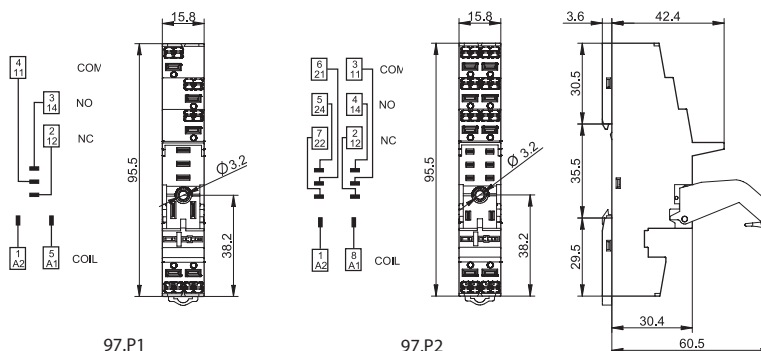

097.58

|  |               |
|--|---------------|
| <b>8-way jumper link</b> for 97.P1 and 97.P2 sockets | <b>097.58</b> |
| Rated values   | 10 A - 250 V  |

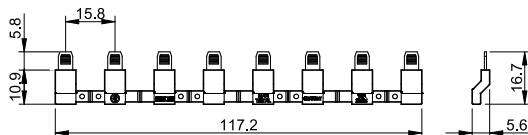

097.52

|  |               |
|--|---------------|
| <b>2-way jumper link</b> for 97.P1 and 97.P2 sockets | <b>097.52</b> |
| Rated values   | 10 A - 250 V  |

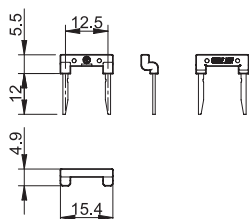



**097.42**

|  |              |
|--|--------------|
| <b>2-way jumper link</b> for 97.P1 and 97.P2 sockets | 097.42       |
| Rated values   | 10 A - 250 V |

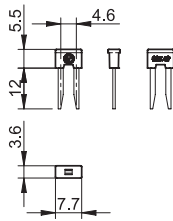

**097.00**

|  |        |
|--|--------|
| <b>Marker tag holder</b> for 95.P3 and 95.P5 sockets | 097.00 |
|--|--------|

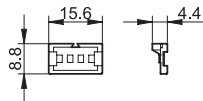

**86.30**

|   |                  |
|---|------------------|
| <b>86 series timer modules</b>                          |                  |
| (12...24)V AC/DC; Bi-function: AI, DI; (0.05 s...100 h) | 86.30.0.024.0000 |
| (110...125)V AC; Bi-function: AI, DI; (0.05 s...100 h)  | 86.30.8.120.0000 |
| (230...240)V AC; Bi-function: AI, DI; (0.05 s...100 h)  | 86.30.8.240.0000 |

Approvals (according to type): **CE EAC cRU<sup>®</sup> US**



**99.02**

Approvals  
(according to type):

**EAC cRU<sup>®</sup> US**

DC Modules with  
non-standard polarity  
(+A2) on request.

|  |                    |                |
|--|--------------------|----------------|
| <b>99.02 coil indication and EMC suppression modules</b> for 97.P1 and 97.P2 sockets |                    |                |
| Diode (+A1, standard polarity)   | (6...220)V DC      | 99.02.3.000.00 |
| LED  | (6...24)V DC/AC    | 99.02.0.024.59 |
| LED  | (28...60)V DC/AC   | 99.02.0.060.59 |
| LED  | (110...240)V DC/AC | 99.02.0.230.59 |
| LED + Diode (+A1, standard polarity)   | (6...24)V DC       | 99.02.9.024.99 |
| LED + Diode (+A1, standard polarity)   | (28...60)V DC      | 99.02.9.060.99 |
| LED + Diode (+A1, standard polarity)   | (110...220)V DC    | 99.02.9.220.99 |
| LED + Varistor   | (6...24)V DC/AC    | 99.02.0.024.98 |
| LED + Varistor   | (28...60)V DC/AC   | 99.02.0.060.98 |
| LED + Varistor   | (110...240)V DC/AC | 99.02.0.230.98 |
| RC circuit   | (6...24)V DC/AC    | 99.02.0.024.09 |
| RC circuit   | (28...60)V DC/AC   | 99.02.0.060.09 |
| RC circuit   | (110...240)V DC/AC | 99.02.0.230.09 |
| Residual current by-pass   | (110...240)V AC    | 99.02.8.230.07 |

A

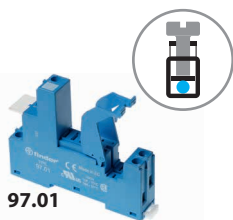

97.01

Approvals  
(according to type):



097.01

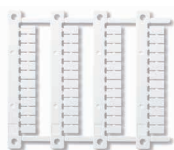

060.48

|   |                     |                        |                     |                        |
|---|---------------------|------------------------|---------------------|------------------------|
| <b>Screw terminal socket panel or 35 mm rail (EN 60715) mount</b> | <b>97.01 (blue)</b> | <b>97.01.0 (black)</b> | <b>97.02 (blue)</b> | <b>97.02.0 (black)</b> |
| For relay type  | 46.61               |                        | 46.52               |                        |

|   |               |  |                  |  |
|---|---------------|--|------------------|--|
| <b>Accessories</b>  |               |  |                  |  |
| Plastic retaining and release clip<br>(supplied with socket - packaging code SPA)                           |               |  | 097.01           |  |
| Metal retaining clip  |               |  | 097.71           |  |
| Marker tag holder   |               |  | 097.00           |  |
| Identification tag  |               |  | 095.00.4         |  |
| 8-way jumper link   | 095.18 (blue) |  | 095.18.0 (black) |  |
| Modules (see table below)   |               |  | 99.02            |  |
| Timer modules (see table below)   |               |  | 86.30            |  |
| Sheet of marker tags for marker tag holder 097.00, 48 tags, 6 x 12 mm, for CEMBRE thermal transfer printers |               |  | 060.48           |  |

|   |  |                             |                 |  |
|---|--|-----------------------------|-----------------|--|
| <b>Technical data</b>                     |  |                             |                 |  |
| Rated values                              | 16 A-250 V AC                              |                             | 8 A-250 V AC    |  |
| Dielectric strength                       | 6 kV (1.2/50 μs) between coil and contacts |                             |                 |  |
| Protection category                       | IP 20                                      |                             |                 |  |
| Ambient temperature                       | °C   | -40...+70 (see diagram L97) |                 |  |
| Screw torque                              | Nm   | 0.8                         |                 |  |
| Wire strip length                         | mm   | 8                           |                 |  |
| Max. wire size for 97.01 and 97.02 socket | solid wire                                 |                             | stranded wire   |  |
|   | mm <sup>2</sup>                            | 1 x 6 / 2 x 2.5             | 1 x 4 / 2 x 2.5 |  |
|   | AWG  | 1 x 10 / 2 x 14             | 1 x 12 / 2 x 14 |  |

**L 97 - Rated current v ambient temperature**  
(for 46.61 relay/97.01 socket combination)

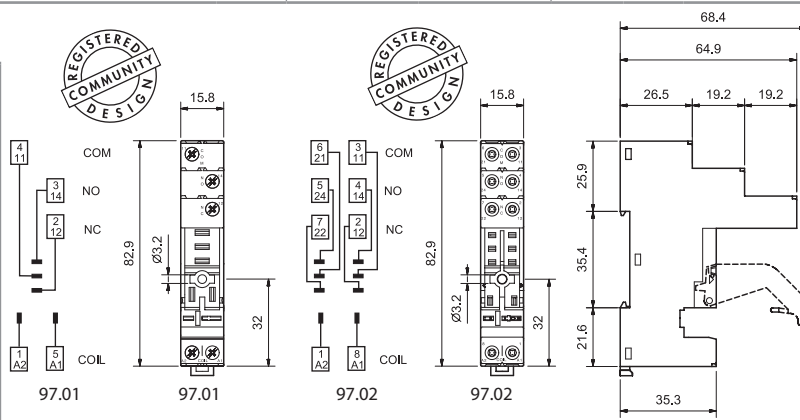
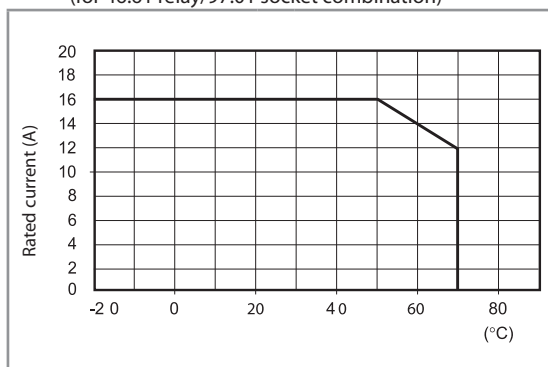

|  |                      |                         |
|--|----------------------|-------------------------|
| <b>8-way jumper link for 97.01 and 97.02 sockets</b> | <b>095.18 (blue)</b> | <b>095.18.0 (black)</b> |
| Rated values   | 10 A - 250 V         |                         |



095.18

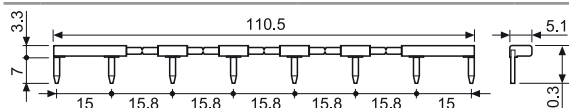

|   |  |                  |
|---|--|------------------|
| <b>86 series timer modules</b>                          |  |                  |
| (12...24)V AC/DC; Bi-function: AI, DI; (0.05 s...100 h) |  | 86.30.0.024.0000 |
| (110...125)V AC; Bi-function: AI, DI; (0.05 s...100 h)  |  | 86.30.8.120.0000 |
| (230...240)V AC; Bi-function: AI, DI; (0.05 s...100 h)  |  | 86.30.8.240.0000 |



86.30

Approvals (according to type):

|  |                    |                |  |  |
|--|--------------------|----------------|--|--|
| <b>99.02 coil indication and EMC suppression modules for 97.01 and 97.02 sockets</b> |                    |                |  |  |
| Diode (+A1, standard polarity)   | (6...220)V DC      | 99.02.3.000.00 |  |  |
| LED  | (6...24)V DC/AC    | 99.02.0.024.59 |  |  |
| LED  | (28...60)V DC/AC   | 99.02.0.060.59 |  |  |
| LED  | (110...240)V DC/AC | 99.02.0.230.59 |  |  |
| LED + Diode (+A1, standard polarity)   | (6...24)V DC       | 99.02.9.024.99 |  |  |
| LED + Diode (+A1, standard polarity)   | (28...60)V DC      | 99.02.9.060.99 |  |  |
| LED + Diode (+A1, standard polarity)   | (110...220)V DC    | 99.02.9.220.99 |  |  |
| LED + Varistor   | (6...24)V DC/AC    | 99.02.0.024.98 |  |  |
| LED + Varistor   | (28...60)V DC/AC   | 99.02.0.060.98 |  |  |
| LED + Varistor   | (110...240)V DC/AC | 99.02.0.230.98 |  |  |
| RC circuit   | (6...24)V DC/AC    | 99.02.0.024.09 |  |  |
| RC circuit   | (28...60)V DC/AC   | 99.02.0.060.09 |  |  |
| RC circuit   | (110...240)V DC/AC | 99.02.0.230.09 |  |  |
| Residual current by-pass   | (110...240)V AC    | 99.02.8.230.07 |  |  |



99.02

Approvals  
(according to type):



DC Modules with non-standard polarity (+A2) on request.



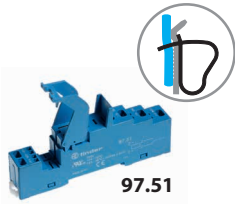

97.51

Approvals  
(according to type):



097.01

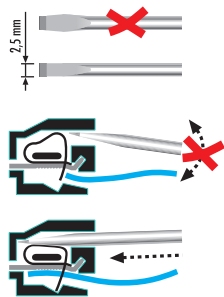

| Screwless terminal socket panel or 35 mm rail (EN 60715) mount                 | 97.51 (blue)                               | 97.51.0 (black) | 97.52 (blue)   | 97.52.0 (black) |
|--|--|-----------------|----------------|-----------------|
| For relay type   | 46.61                                      |                 | 46.52          |                 |
| <b>Accessories</b>   |  |                 |                |                 |
| Plastic retaining and release clip (supplied with socket - packaging code SPA) |  |                 | 097.01         |                 |
| Metal retaining clip   |  |                 | 097.71         |                 |
| Modules (see table below)  |  |                 | 99.02          |                 |
| Timer modules (see table below)  |  |                 | 86.30          |                 |
| <b>Technical data</b>  |  |                 |                |                 |
| Rated values   | 10 A - 250 V AC                            |                 | 8 A - 250 V AC |                 |
| Dielectric strength  | 6 kV (1.2/50 μs) between coil and contacts |                 |                |                 |
| Protection category  | IP 20                                      |                 |                |                 |
| Ambient temperature  | °C -25...+70                               |                 |                |                 |
| Wire strip length  | mm 8                                       |                 |                |                 |
| Max. wire size for 97.51 and 97.52 sockets                                     | solid wire                                 |                 | stranded wire  |                 |
|  | mm <sup>2</sup>                            | 2 x (0.5...1.5) |                | 2 x (0.5...1.5) |
|  | AWG  | 2 x (21...18)   |                | 2 x (21...18)   |

A

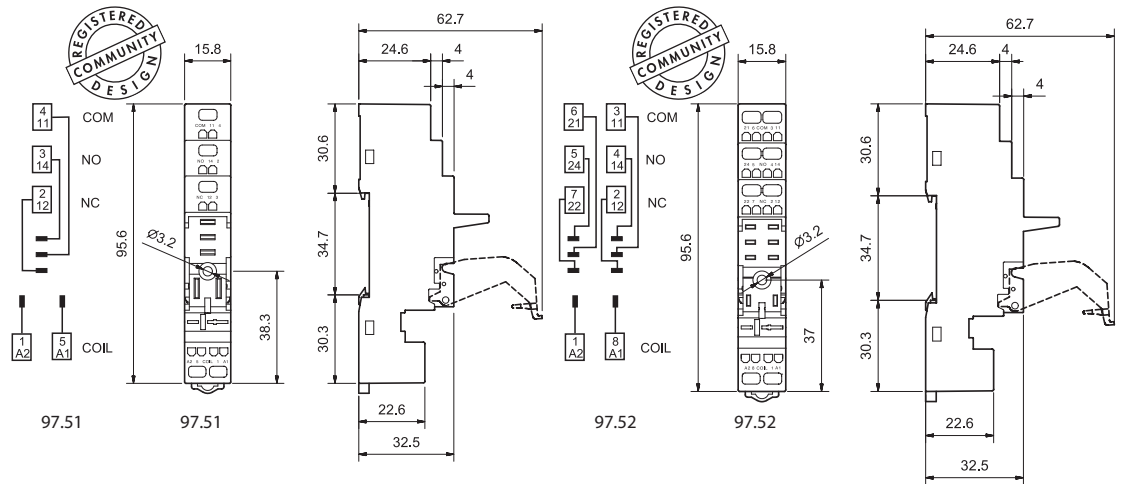

86.30



99.02

Approvals  
(according to type):



DC Modules with non-standard polarity (+A2) on request.

| <b>86 series timer modules</b>                          |                  |
|---|------------------|
| (12...24)V AC/DC; Bi-function: AI, DI; (0.05 s...100 h) | 86.30.0.024.0000 |
| (110...125)V AC; Bi-function: AI, DI; (0.05 s...100 h)  | 86.30.8.120.0000 |
| (230...240)V AC; Bi-function: AI, DI; (0.05 s...100 h)  | 86.30.8.240.0000 |

Approvals (according to type):

| <b>99.02 coil indication and EMC suppression modules for 97.51 and 97.52 sockets</b> |                    |                |
|--|--------------------|----------------|
| Diode (+A1, standard polarity)   | (6...220)V DC      | 99.02.3.000.00 |
| LED  | (6...24)V DC/AC    | 99.02.0.024.59 |
| LED  | (28...60)V DC/AC   | 99.02.0.060.59 |
| LED  | (110...240)V DC/AC | 99.02.0.230.59 |
| LED + Diode (+A1, standard polarity)   | (6...24)V DC       | 99.02.9.024.99 |
| LED + Diode (+A1, standard polarity)   | (28...60)V DC      | 99.02.9.060.99 |
| LED + Diode (+A1, standard polarity)   | (110...220)V DC    | 99.02.9.220.99 |
| LED + Varistor   | (6...24)V DC/AC    | 99.02.0.024.98 |
| LED + Varistor   | (28...60)V DC/AC   | 99.02.0.060.98 |
| LED + Varistor   | (110...240)V DC/AC | 99.02.0.230.98 |
| RC circuit   | (6...24)V DC/AC    | 99.02.0.024.09 |
| RC circuit   | (28...60)V DC/AC   | 99.02.0.060.09 |
| RC circuit   | (110...240)V DC/AC | 99.02.0.230.09 |
| Residual current by-pass   | (110...240)V AC    | 99.02.8.230.07 |

A



**97.11**

Approvals  
(according to type):



**97.12**

Approvals  
(according to type):



| PCB socket            | 97.11 (blue)                               | 97.12 (blue) |
|-----------------------|--|--------------|
| For relay type        | 46.61                                      | 46.52        |
| <b>Technical data</b> |  |              |
| Rated values          | 12 A - 250 V<br>(see diagram L97)          | 8 A - 250 V  |
| Dielectric strength   | 6 kV (1.2/50 μs) between coil and contacts |              |
| Protection category   | IP 20                                      |              |
| Ambient temperature   | °C -40...+70                               |              |

**L 97 - Rated current v ambient temperature**  
(for 46.61 relay/97.11 socket combination)

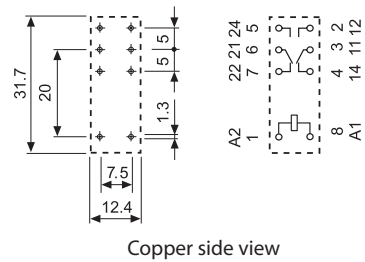
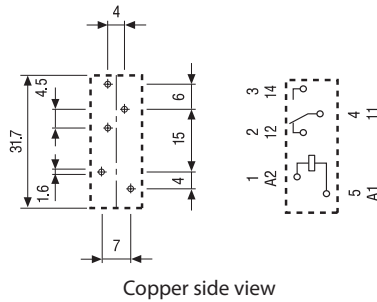
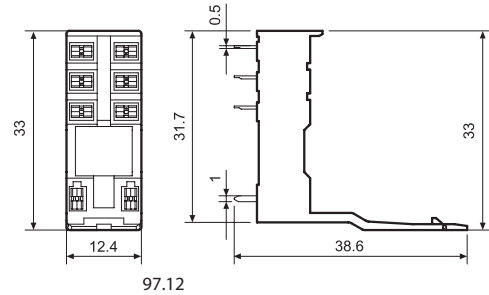
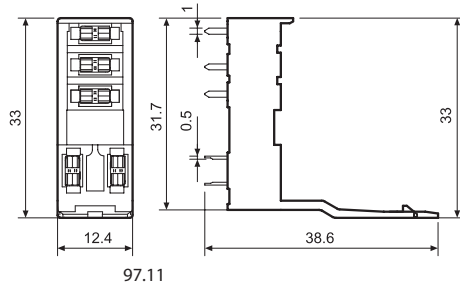
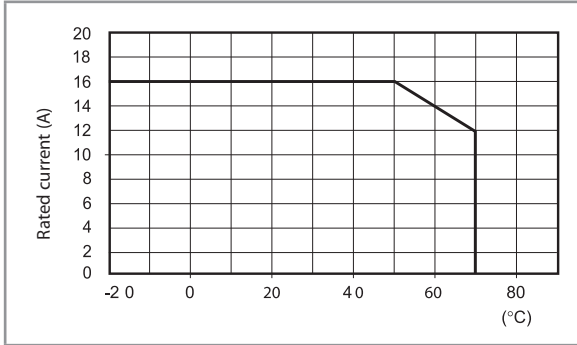

**Packaging codes**

How to code and identify retaining clip and packaging options for sockets.

Example:



- A** Standard packaging
- SM** Metal retaining clip
- SL** Plastic retaining clip