

U-GAGE® T30U Series Sensors - Pump-In/Pump-Out

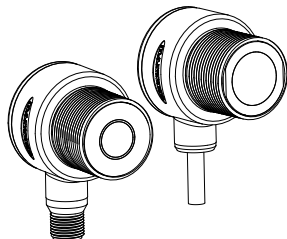

Datasheet

Ultrasonic Sensors with Pump-In/Pump-Out Switching Logic



- Fast, easy-to-use TEACH-Mode programming; no potentiometer adjustments
- Program both outputs together or independently. The two outputs may be identical, independent, overlapping, or complementary
- Remote TEACH for security and convenience
- Choose models with 150 mm to 1 m range (5.9 in to 39.4 in) or 300 mm to 2 m range (11.8 in to 78.7 in)
- Wide operating range of -20 °C to +70 °C (-4 °F to +158 °F)
- Choose models with either NPN or PNP dual discrete outputs
- LED indicators for Power ON/OFF, Signal Strength, and Discrete Outputs Conducting
- Choose models with integral unterminated 2 m (6.5 ft) or 9 m (30 ft) cable, or with M12/Euro-style quick-disconnect connection
- Compact, self-contained, right-angle sensor package with fully encapsulated electronics
- Rugged design for use in demanding sensing environments; rated IEC IP67, NEMA 6P



WARNING:

- **Do not use this device for personnel protection**
- Using this device for personnel protection could result in serious injury or death.
- This device does not include the self-checking redundant circuitry necessary to allow its use in personnel safety applications. A device failure or malfunction can cause either an energized (on) or de-energized (off) output condition.

Models

Models	Range and Frequency	Cable	Supply Voltage	Discrete Output	Response Time
T30UHNA	150 mm to 1 m (5.9 in to 39 in) 228 kHz	2 m (6.5 ft)	12 to 24 V DC	NPN (sinking)	48 ms
T30UHNAQ		5-pin M12/Euro-style QD			
T30UHPA		2 m (6.5 ft)			
T30UHPAQ		5-pin M12/Euro-style QD			
T30UHNB	300 mm to 2 m (11.8 in to 79 in) 128 kHz	2 m (6.5 ft)		NPN (sinking)	96 ms
T30UHNBQ		5-pin M12/Euro-style QD			
T30UHQB		2 m (6.5 ft)			
T30UHQBQ		5-pin M12/Euro-style QD			

Overview

U-GAGE® is an easy-to-use ultrasonic sensor, ideal for demanding environments. Simple push-button programming provides flexibility for a variety of applications. Excellent for gauging applications such as sensing liquid levels in a tank or for sensing most clear materials.

Each sensor includes two discrete outputs, which may be programmed independently with different window limits or together with identical limits.

Pump-In/Pump-Out Switching Function

Pump-in/pump-out operation provides the switching logic required for fill-level control, web tensioning control, and similar applications. In this mode, Output 2 energizes when the target reaches the farthest sensing window limit, and stays energized until the target moves to the nearest limit. Output 1 de-energizes at the farthest limit and does not re-energize until the target moves to the nearest limit. Figure 2 shows how pumping action might be controlled directly by the sensor in a fill-level-control application.

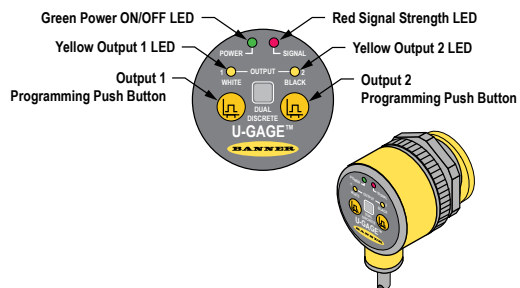

Output 1 = Pump-Out
Output 2 = Pump-In

Figure 1. Sensor features

¹ To order the 9 m (30 ft) cable models, add **W/30** to the model number of any cabled sensor (for example, **T30UHNA W/30**). A model with a QD connector requires an optional mating cable; see [Cordsets](#) (p. 7)



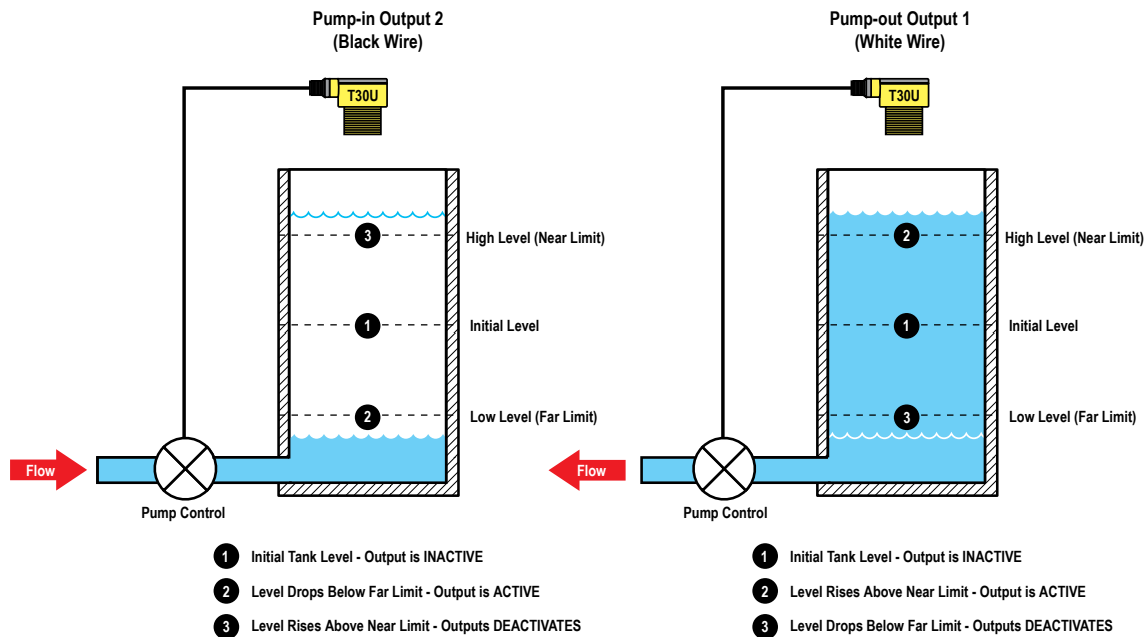

If no echo is received by the sensor, the target is assumed to be beyond the far window limit.

Figure 2. Fill-level-control application

Configuration Instructions

Sensor Programming

Window limits may be taught to the sensor using the push buttons on the back of the sensor or using remote programming.



Note: When the sensor changes state between Program and Run modes, all of the LED indicators turn OFF momentarily, before the appropriate LEDs turn ON. The sensing window limits expand temporarily to full scale (max range) during Program mode.

Program the outputs independently to define separate sensing windows (both their size and placement) or program the outputs simultaneously for complementary operation. Sensing windows may be as large as 0.85 m for 1 m range models, and 1.7 m for 2 m range models. **Note:** Output 1 = White wire (Pump-Out), Output 2 = Black wire (Pump-In).

General Notes on Programming:

1. The sensor returns to Run mode if the first TEACH condition is not registered within 120 seconds.
2. After the first limit is taught, the sensor remains in Program mode until the TEACH sequence is finished.
3. Press and hold the programming push button > 2 seconds (before teaching the second limit) to exit Program mode without saving any changes. The sensor will revert to the last saved program.

Remote Programming

Use the Remote Programming function to program the sensor remotely or to disable the keypad. Disabling the keypad prevents anyone from adjusting any of the programming settings directly from the sensor. Connect the gray wire of the sensor to +12 to 24V dc, with a remote programming switch connected between them.



Note: The impedance of the remote teach input is 55 kΩ.

Follow the sequence of input pulses to program the sensor. The duration of each pulse (corresponding to a push button "click"), and the period between multiple pulses, is defined as: 0.04 seconds < T < 0.8 seconds.



Note: Hold the Remote line high > 2 seconds (before teaching the second limit) to exit Program mode without saving any changes. The sensor will revert to the last saved program.

Teaching Separate Window Limits for Each Output

Each output conducts in its respective manner (either pump-in or pump-out) independently, in response to the target distance. The two outputs may overlap or may be completely independent. For fill-level applications, set the window limits for Output 2 (pump-in) farther from the sensor than for Output 1 (pump-out); see figure on the right.

The distance between the taught near and far limits for each output must be at least 10 mm.

To readjust window limits for either output, follow the teach procedure for that output only.

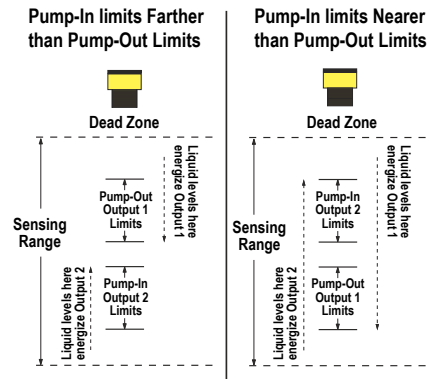







Figure 3. Programming separate sensing window limits for each output

Push Button		Remote Wire 0.04 sec. < T < 0.8 sec.	
Procedure	Result	Procedure	Result
Programming Mode			
<ul style="list-style-type: none"> Push and hold push button for selected output² <p>>2 sec.</p> 	<ul style="list-style-type: none"> Green Power LED turns OFF Corresponding Output LED turns ON Yellow Sensor waits for first limit 	<ul style="list-style-type: none"> No action required 	
Teach First Limit			
<ul style="list-style-type: none"> Position the target for the first limit “Click” the same push button 	<ul style="list-style-type: none"> After a short delay, the Yellow LED flashes Sensor learns first limit and waits for second limit 	<ul style="list-style-type: none"> Position the target for the first limit <p>Output 1 (Pump-Out)</p> <ul style="list-style-type: none"> Double-pulse the remote line  <p>Output 2 (Pump-In)</p> <ul style="list-style-type: none"> Single-pulse the remote line 	<ul style="list-style-type: none"> Green Power LED turns OFF Corresponding Output LED turns ON Yellow After a short delay, the Yellow LED flashes
Teach Second Limit			
<ul style="list-style-type: none"> Position the target for the second limit “Click” the same push button 	<ul style="list-style-type: none"> After a short delay, the Green Power LED goes ON Sensor learns second limit and returns automatically to Run mode 	<ul style="list-style-type: none"> Position the target for the second limit Single-pulse the remote line 	<ul style="list-style-type: none"> After a short delay, the Green Power LED turns ON Sensor learns second limit and returns automatically to Run mode
Program Second Output			
Repeat as needed for other output.			

² Sensor will return to RUN mode if first TEACH condition is not registered within 120 seconds.

Teaching Identical (Complementary) Window Limits for Both Outputs

A Single Pair of Sensing Window Limits is taught; only one output is on at any time

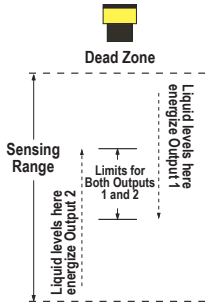

Only one output conducts at any time in response to the target distance. Under no conditions will both outputs conduct at the same time; see *Overview* (p. 1) and the figure on the left.

The distance between the taught near and far limits must be at least 10 mm in this complementary mode for proper sensor operation.

Figure 4. Programming one pair of sensing window limits, complementary outputs

Push Button		Remote Wire 0.04 sec. < T < 0.8 sec.	
Procedure	Result	Procedure	Result
Programming Mode			
<ul style="list-style-type: none"> Press and hold both push buttons (or press and hold one and then the other)³ <p>>2 sec.</p>	<ul style="list-style-type: none"> Green Power LED turns OFF Both Output LEDs turn ON Yellow Sensor waits for first limit 	<ul style="list-style-type: none"> No action required 	
Teach First Limit			
<ul style="list-style-type: none"> Position the target for the first limit “Click” either push button 	<ul style="list-style-type: none"> After a short delay, the Yellow LEDs flashes Sensor learns first limit and waits for second limit 	<ul style="list-style-type: none"> Position the target for the first limit Triple-pulse the remote line 	<ul style="list-style-type: none"> Green Power LED turns OFF Both Output LEDs turn ON Yellow After a short delay, the Yellow LEDs flash
Teach Second Limit			
<ul style="list-style-type: none"> Position the target for the second limit “Click” either push button 	<ul style="list-style-type: none"> After a short delay, the Green Power LED goes ON Sensor learns second limit and returns automatically to Run mode 	<ul style="list-style-type: none"> Position the target for the second limit Single-pulse the remote line 	<ul style="list-style-type: none"> After a short delay, the Green Power LED turns ON Sensor learns second limit and returns automatically to Run mode

³ Sensor will return to RUN mode if first TEACH condition is not registered within 120 seconds.

Push Button Lockout

Push Button		Remote Wire 0.04 sec. < T < 0.8 sec.	
Procedure	Result	Procedure	Result
Not available via push button	Not applicable	<ul style="list-style-type: none"> Four-pulse the remote line 	<ul style="list-style-type: none"> Push buttons are either enabled or disabled, depending on previous condition

Wiring Diagrams

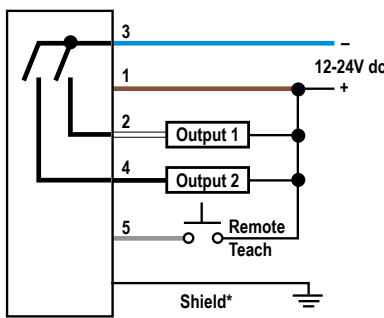

Figure 5. Cabled NPN

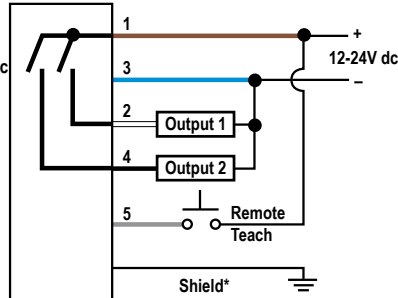

Figure 6. Cabled PNP

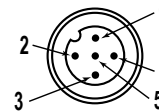

Figure 7. 5-pin M12/Euro-style male connector

- 1 = Brown
- 2 = White
- 3 = Blue
- 4 = Black
- 5 = Gray

It is recommended that the shield wire is connected to earth ground or dc common.

Run Mode



Note: All LED indicators momentarily turn OFF when sensor changes state between Program and Run modes.

Signal LED

The Red Signal LED indicates the strength and condition of the sensor's incoming signal.

Signal LED Status	Indicates
OFF	No signal is received, or the target is beyond the range limitations of the sensor (with some tolerance beyond the recommended minimum and maximum sensing distance)
Flashing	Relative received signal strength; the faster the LED flashes, the stronger the signal

Output LEDs

Each Yellow Output LED lights when the corresponding output (pump-in or pump-out) is energized.

Power ON/OFF LED

The Green Power ON/OFF LED indicates the operating status of the sensor.

Power ON/OFF LED	Indicates
OFF	Power is OFF (or in Program mode, if other LEDs are ON)
ON Solid	Sensor is operating normally (power is ON, Run mode)
Flashing	Discrete output is overloaded (Run mode)

Self-Diagnostic Error Mode

In the unlikely event of a microprocessor memory error, all of the LEDs will flash in sequence. If this occurs, the setup parameters have been lost and the sensor may be corrupt. Contact Banner Engineering for further information.

Specifications

Proximity Mode Range

"A" suffix models: 150 mm (5.9 in) min. near limit; 1 m (39 in) max. far limit
"B" suffix models: 300 mm (11.8 in) min. near limit; 2 m (79 in) max. far limit

Supply Voltage

12 to 24 V dc (10% max. ripple) at 90 mA, exclusive of load

Supply Protection Circuitry

Protected against reverse polarity and transient voltages

Output Ratings

Dual Discrete Outputs: 100 mA maximum, total – both outputs

OFF-state leakage current: less than 10 microamps

ON-state saturation voltage: less than 1 V at 10 mA and less than 1.5 V at 100 mA

Output Configurations

SPST solid-state switch; choose NPN (current sinking) or PNP (current sourcing) models

Output Protection

Protected against continuous overload and short-circuit; transient over-voltage; no false pulse on power-up

Output Response Time

"A" suffix models: 48 milliseconds

"B" suffix models: 96 milliseconds

Sensing Performance

Sensing repeatability: $\pm 0.25\%$ of distance

Minimum window size: 10 mm (0.4 in)

Hysteresis of discrete output: 2.5 mm (0.10 in)

Adjustments

Sensing window limits: TEACH-mode programming of near and far window limits may be set using membrane push buttons on sensor or remotely via TEACH input. Window limits may be programmed separately, or together

Construction

Molded reinforced thermoplastic polyester housing

Environmental Rating

Leakproof design is rated IEC IP67, NEMA 6P

Connections

2 m (6.5 ft) or 9 m (30 ft) 5-conductor PVC-covered attached cable, or 5-pin Euro-style quick-disconnect fitting

Operating Conditions

Temperature: $-20\text{ }^{\circ}\text{C}$ to $+70\text{ }^{\circ}\text{C}$ ($-4\text{ }^{\circ}\text{F}$ to $+158\text{ }^{\circ}\text{F}$)

Humidity: 100% maximum relative humidity

Vibration and Mechanical Shock

All models meet Mil. Std. 202F requirements. Method 201A (Vibration: 10 to 60 Hz max., double amplitude 0.06 in, maximum acceleration 10G). Also meets IEC 947-5-2 requirements: 30G, 11 ms duration, half sine wave

Certifications



Application Notes

Objects passing inside the specified near limit will produce a false response

Indicators

Status LEDs	Run Mode	Program mode
Green	ON: Power ON, Run mode Flashing: Output is overloaded	OFF: Program Mode
Red	Flashing: Relative received signal strength	Flashing: Relative received signal strength
Amber (2)	ON: Output energized (conducting)	ON: Ready for first window limit
		Flashing: Ready for second limit
		OFF: Not teaching this output

Performance Curves

Effective Beam with Plate Target (Typical)

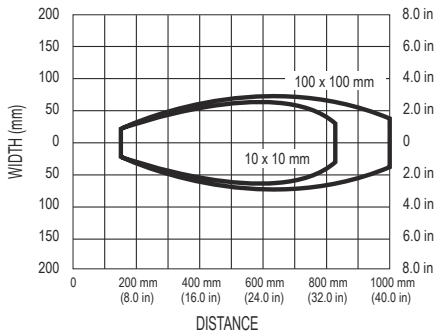

Figure 8. A Models

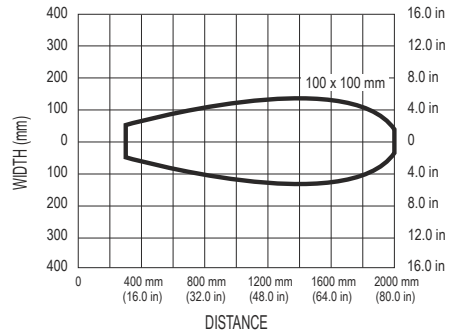

Figure 9. B Models

Effective Beam with Rod Target (Typical)

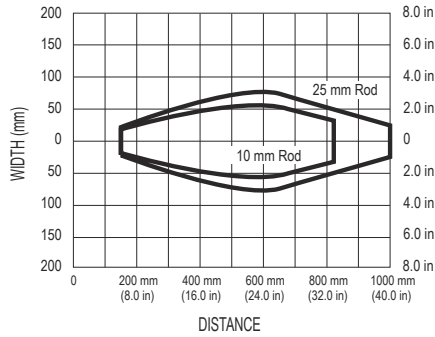

Figure 10. A Models

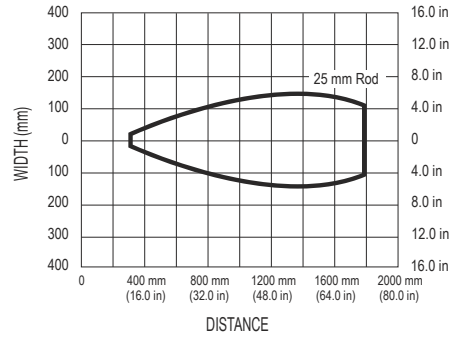
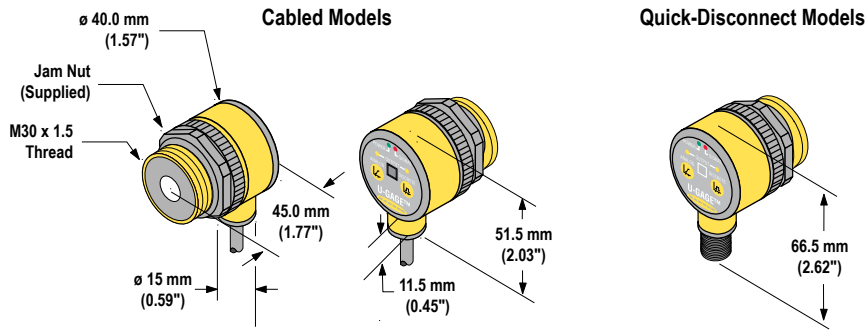

Figure 11. B Models

Dimensions



Accessories

Cordsets

5-Pin Threaded M12/Euro-Style Cordsets with Shield—Single Ended				
Model	Length	Style	Dimensions	Pinout (Female)
MQDEC2-506	1.83 m (6 ft)	Straight		<p>1 = Brown 2 = White 3 = Blue 4 = Black 5 = Gray</p>
MQDEC2-515	4.57 m (15 ft)			
MQDEC2-530	9.14 m (30 ft)			
MQDEC2-550	15.2 m (50 ft)	Right-Angle		
MQDEC2-506RA	1.83 m (6 ft)			
MQDEC2-515RA	4.57 m (15 ft)			
MQDEC2-530RA	9.14 m (30 ft)			
MQDEC2-550RA	15.2 m (50 ft)			

Brackets

All measurements are in mm.

SMB30A

- Right-angle bracket with curved slot for versatile orientation
- Clearance for M6 (¼ in) hardware
- Mounting hole for 30 mm sensor
- 12-ga. stainless steel

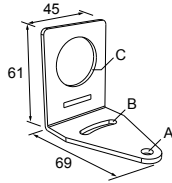

Hole center spacing: A to B=40
Hole size: A=ø 6.3, B= 27.1 x 6.3, C=ø 30.5

SMB1815SF

- Swivel with set screws for mounting sensors by the cable hub
- Black reinforced thermoplastic polyester
- Stainless steel swivel locking hardware and hex wrench included

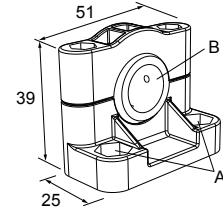

Hole center spacing: A = 36.0
Hole size: A = ø 5.0, B = ø 15.0

SMB30FA

- Swivel bracket with tilt and pan movement for precise adjustment
- Mounting hole for 30 mm sensor
- 12-ga. 304 stainless steel
- Easy sensor mounting to extrude rail T-slot
- Metric and inch size bolt available

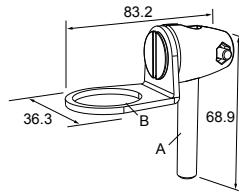

Bolt thread: SMB30FA, A= 3/8 - 16 x 2 in; SMB30FAM10, A= M10 - 1.5 x 50
Hole size: B= ø 30.1

SMB30SC

- Swivel bracket with 30 mm mounting hole for sensor
- Black reinforced thermoplastic polyester
- Stainless steel mounting and swivel locking hardware included

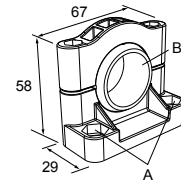

Hole center spacing: A=ø 50.8
Hole size: A=ø 7.0, B=ø 30.0

Banner Engineering Corp. Limited Warranty

Banner Engineering Corp. warrants its products to be free from defects in material and workmanship for one year following the date of shipment. Banner Engineering Corp. will repair or replace, free of charge, any product of its manufacture which, at the time it is returned to the factory, is found to have been defective during the warranty period. This warranty does not cover damage or liability for misuse, abuse, or the improper application or installation of the Banner product.

THIS LIMITED WARRANTY IS EXCLUSIVE AND IN LIEU OF ALL OTHER WARRANTIES WHETHER EXPRESS OR IMPLIED (INCLUDING, WITHOUT LIMITATION, ANY WARRANTY OF MERCHANTABILITY OR FITNESS FOR A PARTICULAR PURPOSE), AND WHETHER ARISING UNDER COURSE OF PERFORMANCE, COURSE OF DEALING OR TRADE USAGE.

This Warranty is exclusive and limited to repair or, at the discretion of Banner Engineering Corp., replacement. **IN NO EVENT SHALL BANNER ENGINEERING CORP. BE LIABLE TO BUYER OR ANY OTHER PERSON OR ENTITY FOR ANY EXTRA COSTS, EXPENSES, LOSSES, LOSS OF PROFITS, OR ANY INCIDENTAL, CONSEQUENTIAL OR SPECIAL DAMAGES RESULTING FROM ANY PRODUCT DEFECT OR FROM THE USE OR INABILITY TO USE THE PRODUCT, WHETHER ARISING IN CONTRACT OR WARRANTY, STATUTE, TORT, STRICT LIABILITY, NEGLIGENCE, OR OTHERWISE.**

Banner Engineering Corp. reserves the right to change, modify or improve the design of the product without assuming any obligations or liabilities relating to any product previously manufactured by Banner Engineering Corp. Any misuse, abuse, or improper application or installation of this product or use of the product for personal protection applications when the product is identified as not intended for such purposes will void the product warranty. Any modifications to this product without prior express approval by Banner Engineering Corp will void the product warranties. All specifications published in this document are subject to change; Banner reserves the right to modify product specifications or update documentation at any time. Specifications and product information in English supersede that which is provided in any other language. For the most recent version of any documentation, refer to: www.bannerengineering.com.

For patent information, see www.bannerengineering.com/patents.