

A15 Series Pilot Valve

The Humphrey **A15 Series Pilot Valve** is perfect for equipment or device makers requiring electrically controlled pneumatic signals. Available in Normally Closed or Normally Open configurations with lead wires or Mini-DIN electrical entry in 12VDC or 24VDC. These sub-base mount, direct-acting valves have a life expectancy up to 50 million cycles.

Valves feature fluorocarbon seals and an encapsulated coil affixed to a molded valve body made of PPS. Sub-base seal is retained within the valve body. Non-locking, recessed manual override is standard equipment.

A15 Valves have excellent flow of 0.05 Cv and low 2.5 watt power consumption in a compact 15mm wide valve body. Customized flow/power consumption requirements are possible. Inquire with factory for availability.

All valves are registered CE, and are RoHS and REACH compliant.



A151039 with HS2



A151138



A151039

Schematics

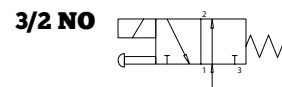
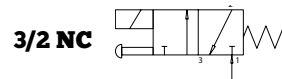

Section Drawing/ISOs with dimensions

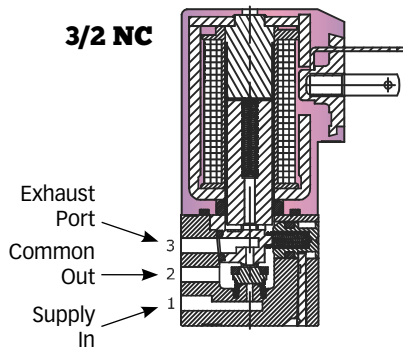

A151039

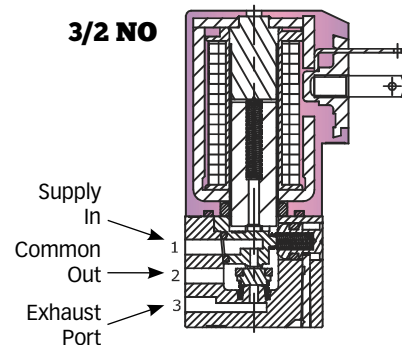

A151138

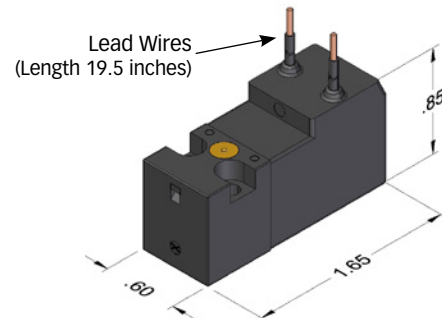
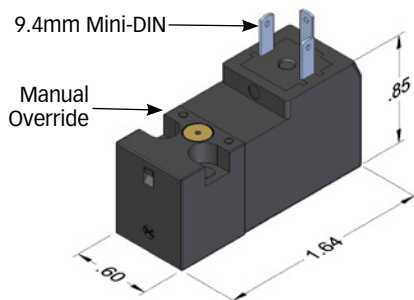

A15 Specifications

Type of Operation:	Direct Solenoid
Function:	2- and 3-Way, NC or NO
Media:	Air or inert gas
Pressure Range:	0 ~ 100 PSIG
Temperature Range:	14° to 122° F (-10° to 50°C)
Flow – Cv:	0.05
Response Time:	ON: 15 ms OFF: 15 ms
Orifice:	1.0 mm
Lubrication:	Not required
Filtration:	DIN ISO 8573-1 CLASS 3-4-4
Weight:	40 grams
Materials:	Glass Filled Nylon, Copper, PPS, FKM, SST
Max. Cycle Rate:	2000 cpm
Voltage Tolerance:	+/- 10%
Power:	2.5 watts
Override:	Non-Locking

Basic Size/Ports Dimensional

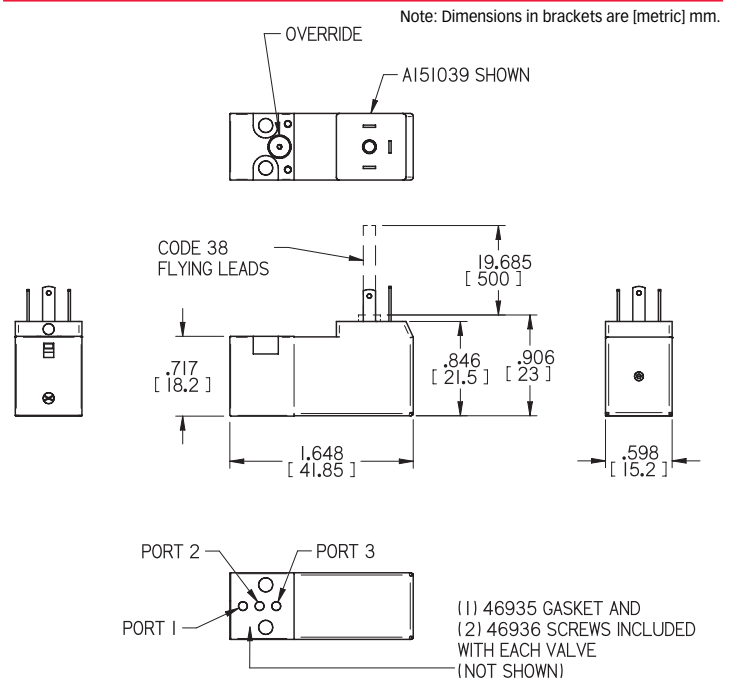

DIN Receptacles, Accessory

MODEL	DESCRIPTION	NOTES
HS2	DIN	
HS2LED-12VDC	DIN w/12VDC LED	Receptacle for A15_39 models
HS2LED-24VDC	DIN w/24VDC LED	
46936	Valve to Manifold Mtg. Screw	1 piece

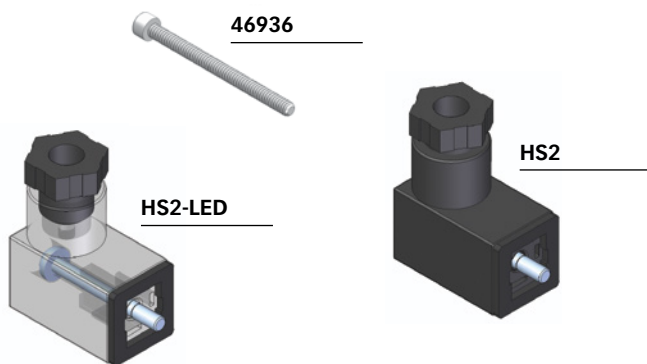

Foot Print Dimensional

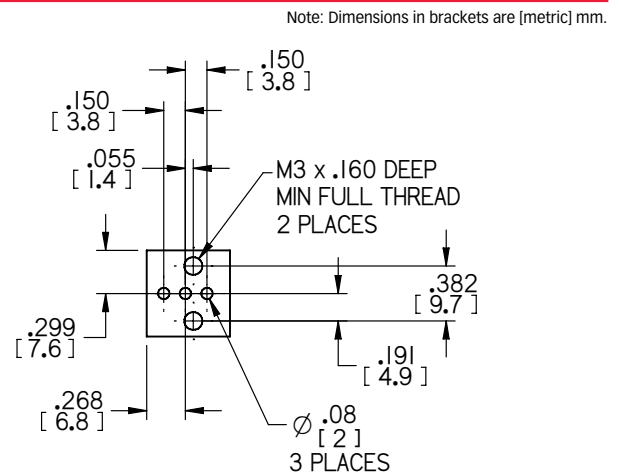

HOW TO ORDER A15 Series Pilot Valve



A15

TYPE

Normally Closed - 10
Normally Open - 11

ELECTRICAL ENTRY

Lead Wires - 38
9.4mm Mini-DIN - 39

VOLTAGE

12VDC
24VDC

Order Examples: A15103812VDC
A15113924VDC