



**■ Features**

- Constant voltage PWM style output with frequency up to 4kHz compliant IEEE1789-2015
- Plastic housing with class II and PFC design
- Emergency lighting application is available according to IEC61347-2-13
- Standby power consumption <0.5W
- Fully encapsulated with IP67 level
- Function options: 3 in 1 dimming (dim-to-off and Isolated Design)/DALI-2
- Minimum dimming level 0.2% for DA2 type
- Typical lifetime >50000 hrs and 5 years warranty

**■ Applications**

- LED strip lighting
- Indoor LED lighting
- LED decorative lighting
- LED architecture lighting
- Cove lighting
- Industrial lighting
- Type “HL” for use in class I, division 2 hazardous (classified) location.

**■ Description**

PWM-200 series is a 200W AC/DC LED driver featuring the constant voltage mode with PWM style output, which is able to maintain the color temperature and the brightness homogeneity when driving all kinds of LED strips. PWM-200 operates from 100~305VAC and offers models with different rated voltage ranging between 12V and 48V. Thanks to the high efficiency up to 94% with the fanless design, the entire series is able to operate for -40°C ~ +85°C case temperature under free air convection. The entire series is rated with IP67 ingress protection level and is suitable to work for dry, damp or wet locations. PWM-200 is equipped with dimming function that varies the duty cycle of the output, providing great flexibility for LED strips applications.

**■ Model Encoding**

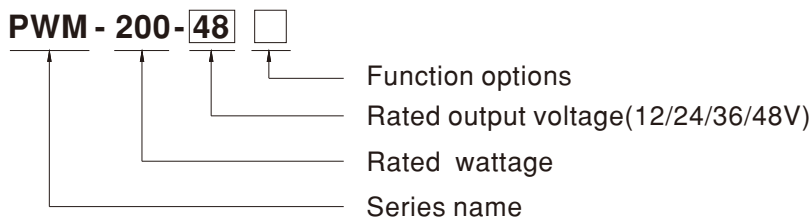

Type	IP Level	Function	Note
Blank	IP67	3 in 1 dimming function (0~10Vdc, 10V PWM signal and resistance)	In stock
DA2	IP67	Push Dimming or DALI-2 control technology.	In stock

SPECIFICATION

MODEL		PWM-200-12 □	PWM-200-24 □	PWM-200-36 □	PWM-200-48 □
OUTPUT	DC VOLTAGE	12V	24V	36V	48V
	RATED CURRENT	15A	8.3A	5.55A	4.17A
	RATED POWER	180W	199.2W	199.8W	200.1W
	DIMMING RANGE	0 ~ 100%			
	PWM FREQUENCY (Typ.)	4kHz for Blank type; 2.5kHz for DA2 type			
	SETUP, RISE TIME <small>Note.2 Note.10</small>	500ms, 80ms/230VAC or 115VAC			
	HOLD UP TIME (Typ.)	10ms/230VAC or 115VAC			
INPUT	VOLTAGE RANGE <small>Note.3</small>	100 ~ 305VAC    142 ~ 431VDC (Please refer to "STATIC CHARACTERISTIC" section)			
	FREQUENCY RANGE	47 ~ 63Hz			
	POWER FACTOR (Typ.)	PF>0.97/115VAC, PF>0.96/230VAC, PF>0.94/277VAC @ full load (Please refer to "POWER FACTOR (PF) CHARACTERISTIC" section)			
	TOTAL HARMONIC DISTORTION	THD<20% (@load≥60%/115VAC, 230VAC; @load≥75%/277VAC) (Please refer to "TOTAL HARMONIC DISTORTION" section)			
	EFFICIENCY (Typ.)	92%	93%	94%	94%
	AC CURRENT (Typ.)	2.2A / 115VAC	1.1A / 230VAC	0.9A / 277VAC	
	INRUSH CURRENT (Typ.)	COLD START 65A(twidth=550μs measured at 50% Ipeak) at 230VAC; Per NEMA 410			
	MAX. NO. of PSUs on 16A CIRCUIT BREAKER	3 units (circuit breaker of type B) / 5 units (circuit breaker of type C) at 230VAC			
	LEAKAGE CURRENT	<0.75mA / 277VAC			
	STANDBY POWER CONSUMPTION	standby power consumption<0.5W when dimming off			
PROTECTION	OVERLOAD	108 ~ 135% rated output power Hiccup mode or Constant current limiting, recovers automatically after fault condition is removed			
	SHORT CIRCUIT	Shut down o/p voltage, re-power on to recover (except for DA2-type) Hiccup mode, recovers automatically after fault condition is removed (only for DA2-type)			
	OVER VOLTAGE	13 ~ 18V	27 ~ 34V	41 ~ 49V	53 ~ 65V
	OVER TEMPERATURE	Shut down o/p voltage, re-power on to recover after fault condition is removed			
ENVIRONMENT	WORKING TEMP.	Tcase=-40 ~ +85°C (Please refer to "OUTPUT LOAD vs TEMPERATURE" section)			
	MAX. CASE TEMP.	Tcase=+85°C			
	WORKING HUMIDITY	20 ~ 95% RH non-condensing			
	STORAGE TEMP., HUMIDITY	-40 ~ +80°C, 10 ~ 95% RH			
	TEMP. COEFFICIENT	±0.03%/°C (0 ~ 50°C)			
SAFETY & EMC	VIBRATION	10 ~ 500Hz, 5G 12min./1cycle, period for 72min. each along X, Y, Z axes			
	SAFETY STANDARDS <small>Note.5</small>	UL8750( type "HL" ), CSA C22.2 No. 250.13-12; ENEC BS EN/EN61347-1, BS EN/EN61347-2-13, BS EN/EN62384 independent, IP67, EAC TP TC 004, GB19510.1, GB19510.14 approved; Design refer to BS EN/EN60335-1, According to BS EN/EN61347-2-13 appendix J suitable for emergency installations			
	DALI STANDARDS	Comply with IEC62386-101, 102, 207, 251 for DA2 Type only, Device type 6(DT6)			
	WITHSTAND VOLTAGE	I/P-O/P: 3.75KVAC; I/P-DA: 1.5KVAC; O/P-DA:1.5KVAC			
	ISOLATION RESISTANCE	I/P-O/P: 100M Ohms / 500VDC / 25°C / 70% RH			
	EMC EMISSION <small>Note.6</small>	Compliance to BS EN/EN55015, BS EN/EN61000-3-2 Class C (@load≥60%); BS EN/EN61000-3-3, GB17743 and GB17625.1, EAC TP TC 020			
OTHERS	EMC IMMUNITY	Compliance to BS EN/EN61000-4-2,3,4,5,6,8,11; BS EN/EN61547, light industry level (surge immunity, Line-Line 2KV), EAC TP TC 020			
	MTBF	712.8 K hrs min. Telcordia SR-332 (Bellcore); 178.7 K hrs min. MIL-HDBK-217F (25°C)			
	DIMENSION	195*68*39.5mm (L*W*H)			
NOTE	PACKING	1.03Kg; 12pcs/ 13.4Kg/ 0.71CUFT			
	NOTE	<ol style="list-style-type: none"> <li>All parameters NOT specially mentioned are measured at 230VAC input, rated current and 25°C of ambient temperature.</li> <li>Length of set up time is measured at first cold start. Turning ON/OFF the driver may lead to increase of the set up time.</li> <li>De-rating may be needed under low input voltages. Please refer to "STATIC CHARACTERISTIC" sections for details.</li> <li>The driver is considered as a component that will be operated in combination with final equipment. Since EMC performance will be affected by the complete installation, the final equipment manufacturers must re-quality EMC Directive on the complete installation again.</li> <li>This series meets the typical life expectancy of &gt;50,000 hours of operation when Tcase, particularly (tc) point (or TMP, per DLC), is about 75°C or less.</li> <li>Please refer to the warranty statement on MEAN WELL's website at <a href="http://www.meanwell.com">http://www.meanwell.com</a></li> <li>The ambient temperature derating of 3.5°C/1000m with fanless models and of 5°C/1000m with fan models for operating altitude higher than 2000m(6500ft).</li> <li>For any application note and IP water proof function installation caution, please refer our user manual before using. <a href="https://www.meanwell.com/Upload/PDF/LED_EN.pdf">https://www.meanwell.com/Upload/PDF/LED_EN.pdf</a></li> <li>It is not recommended to connect to capacitive loads</li> <li>Based on IEC 62386-101/102 DALI power on timing and interruption regulations, the set up time needs to test with a DALI controller which can support for DALI power on function, otherwise the set up time will be higher than 0.5 second for DA2 type.</li> <li>To fulfill requirements of the latest ErP regulation for lighting fixtures, this LED power supply can only be used behind a switch without permanently connected to the mains.</li> </ol>			

1. All parameters NOT specially mentioned are measured at 230VAC input, rated current and 25°C of ambient temperature.  
 2. Length of set up time is measured at first cold start. Turning ON/OFF the driver may lead to increase of the set up time.  
 3. De-rating may be needed under low input voltages. Please refer to "STATIC CHARACTERISTIC" sections for details.  
 4. The driver is considered as a component that will be operated in combination with final equipment. Since EMC performance will be affected by the complete installation, the final equipment manufacturers must re-quality EMC Directive on the complete installation again.  
 5. This series meets the typical life expectancy of >50,000 hours of operation when Tcase, particularly (tc) point (or TMP, per DLC), is about 75°C or less.  
 6. Please refer to the warranty statement on MEAN WELL's website at <http://www.meanwell.com>  
 7. The ambient temperature derating of 3.5°C/1000m with fanless models and of 5°C/1000m with fan models for operating altitude higher than 2000m(6500ft).  
 8. For any application note and IP water proof function installation caution, please refer our user manual before using. [https://www.meanwell.com/Upload/PDF/LED\\_EN.pdf](https://www.meanwell.com/Upload/PDF/LED_EN.pdf)  
 9. It is not recommended to connect to capacitive loads  
 10. Based on IEC 62386-101/102 DALI power on timing and interruption regulations, the set up time needs to test with a DALI controller which can support for DALI power on function, otherwise the set up time will be higher than 0.5 second for DA2 type.  
 11. To fulfill requirements of the latest ErP regulation for lighting fixtures, this LED power supply can only be used behind a switch without permanently connected to the mains.  
 ※ Product Liability Disclaimer : For detailed information, please refer to <https://www.meanwell.com/serviceDisclaimer.aspx>
File Name: PWM-200-SPEC 2022-01-24

## DIMMING OPERATION

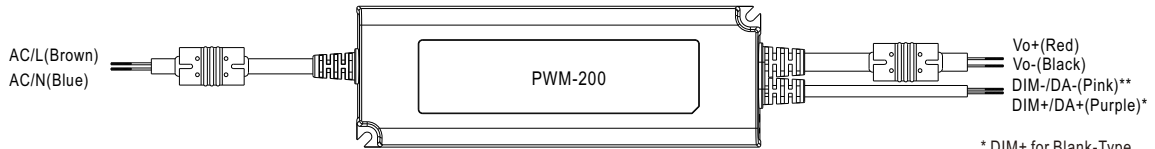

\* DIM+ for Blank-Type  
 DA+ for DA2-type  
 \*\* DIM-/DA- for Blank-Type  
 DA- for DA2-type

### ※ Dimming principle for PWM style output

- Dimming is achieved by varying the duty cycle of the output current.



$$\text{Duty cycle(\%)} = \frac{T_{ON}}{T} \times 100\%$$

Output PWM frequency : 4KHz fixed (Blank type)  
 2.5KHz fixed (DA2 type)

### ※ 3 in 1 dimming function (for Blank-Type)

- Apply one of the three methodologies between DIM+ and DIM-: 0 ~ 10VDC, or 10V PWM signal or resistance.
- Dimming source current from power supply: 100μA (typ.)

#### ◎ Applying additive 0 ~ 10VDC

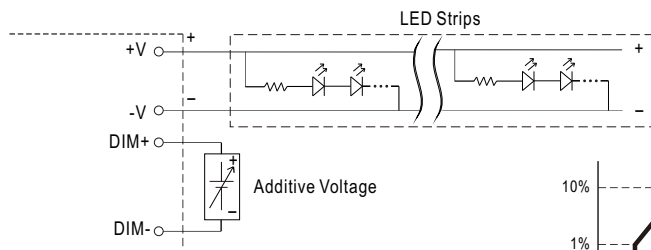

"DO NOT connect "DIM- to -V"

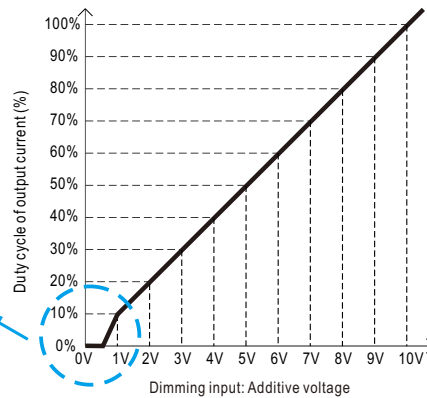
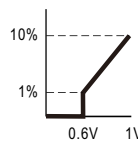

#### ◎ Applying additive 10V PWM signal (frequency range 100Hz ~ 3KHz):

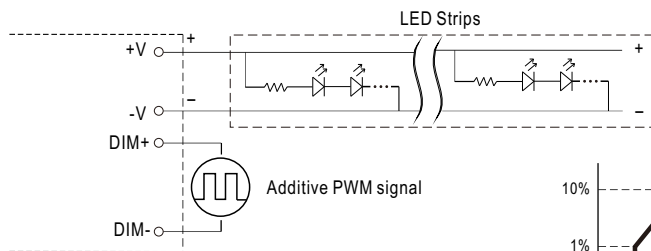

"DO NOT connect "DIM- to -V"

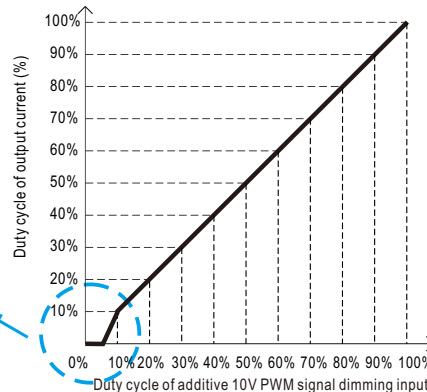
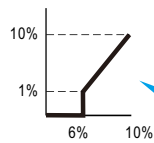

◎Applying additive resistance:

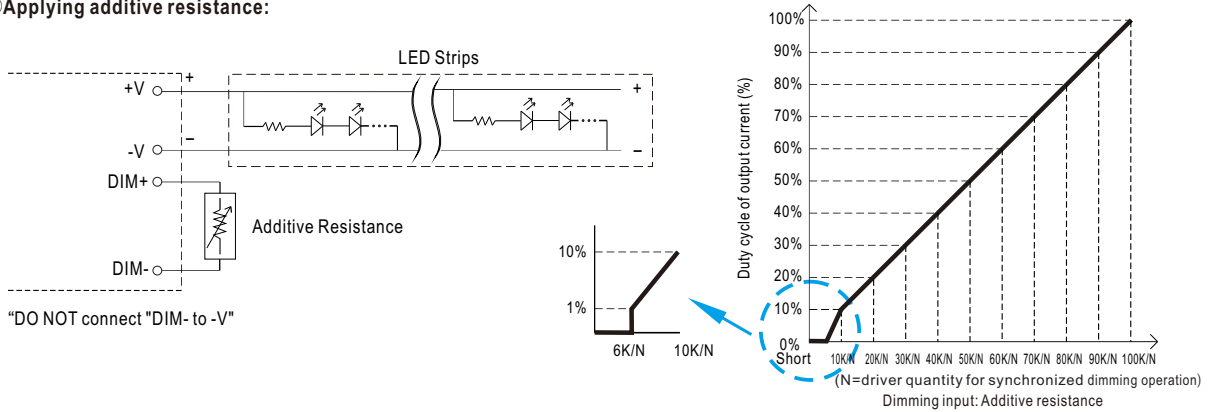

Note : 1. Min. duty cycle of output current is about 1%, and the dimming input is about 6KΩ or 0.6VDC, or 10V PWM signal with 6% duty cycle.  
 2. The duty cycle of output current could drop down to 0% when dimming input is less than 6KΩ or less than 0.6VDC, or 10V PWM signal with duty cycle less than 6%.

※DALI interface

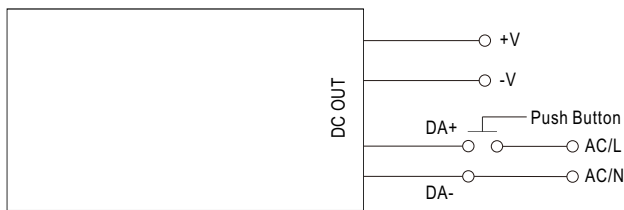

◎ PUSH dimming(primary side)

Action	Action duration	Function
Short push	0.1~1 sec.	Turn ON-OFF the driver
Long push	1.5~10 sec.	Every Long Push changes the dimming direction, dimming up or down
Reset	>11 sec.	Set up the dimming level to 100%

- The factory default dimming level is at 100%.
- If the push action lasts less than 0.05 sec., it will not lead to a change for the status of the driver.
- Up to 10 drivers can perform the PUSH dimming at the same time when utilizing one common push button.
- The maximum length of the cable from the push button to the last driver is 20 meters.
- The additive push button can be connected only between the DA+ terminal, as displayed in the diagram, and AC/L (in brown or black); it will lead to short circuit if it is connected to AC/N.

◎ DALI Interface (for DA2-Type)

- Apply DALI signal between DA+ and DA-.
- DALI protocol comprises 16 groups and 64 addresses.
- Min. duty cycle of output current is about 0.2%

### OUTPUT LOAD vs TEMPERATURE

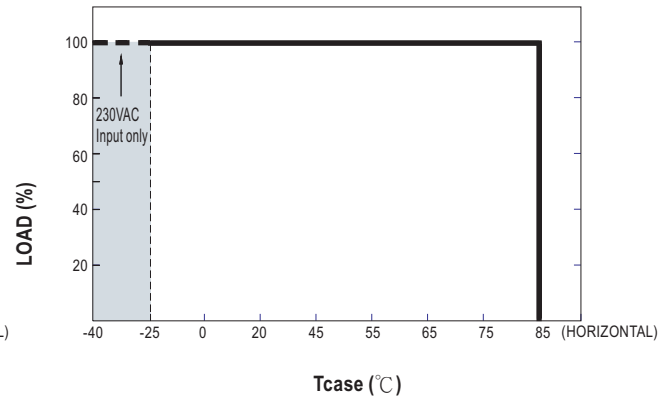
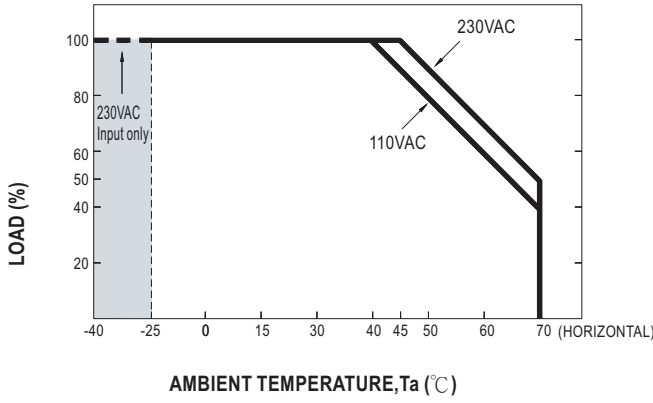

### STATIC CHARACTERISTIC

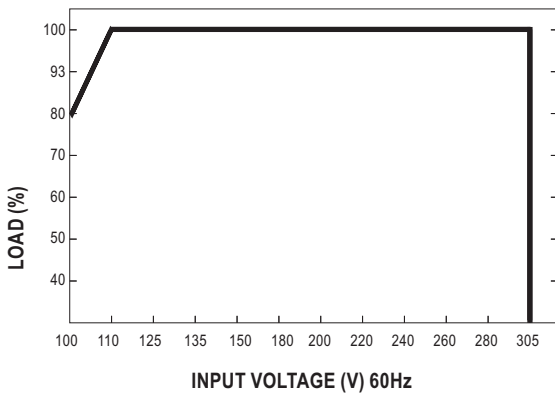

### POWER FACTOR (PF) CHARACTERISTIC

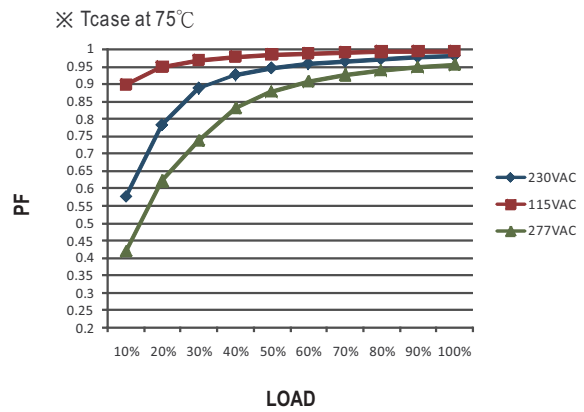

### TOTAL HARMONIC DISTORTION (THD)

※ 48V Model,  $T_{case}$  at 75°C

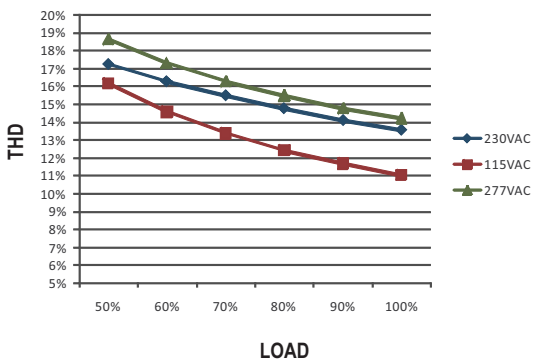

### EFFICIENCY vs LOAD

PWM-200 series possess superior working efficiency that up to 94% can be reached in field applications.

※ 48V Model,  $T_{case}$  at 75°C

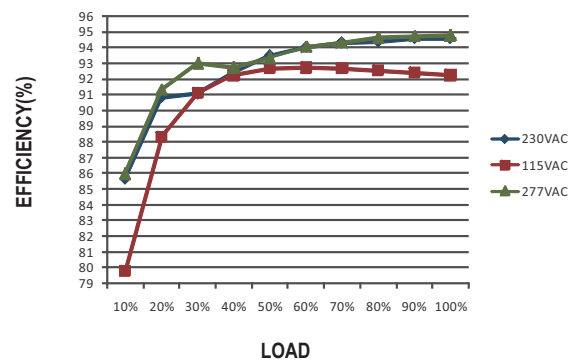



■ LIFE TIME

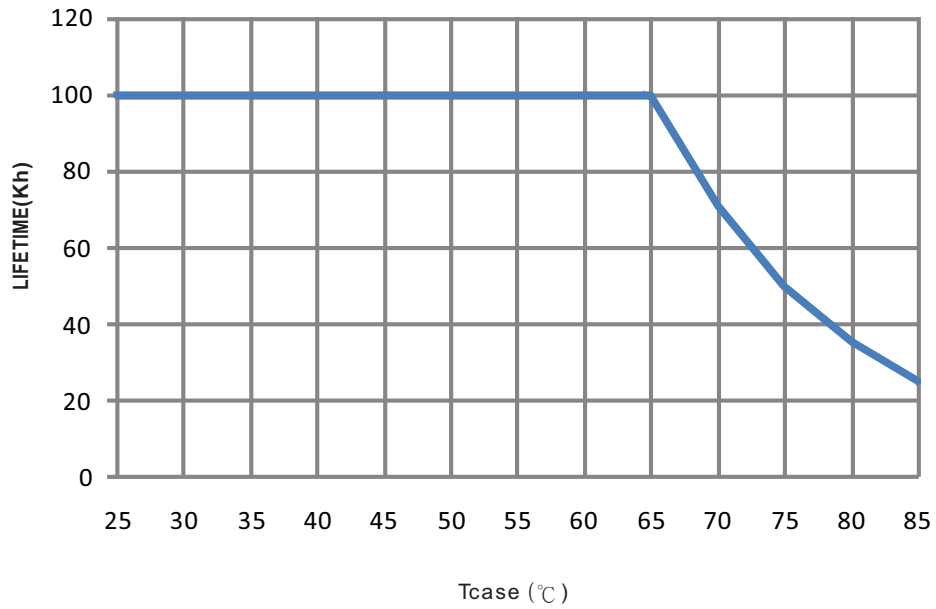

### Block Diagram

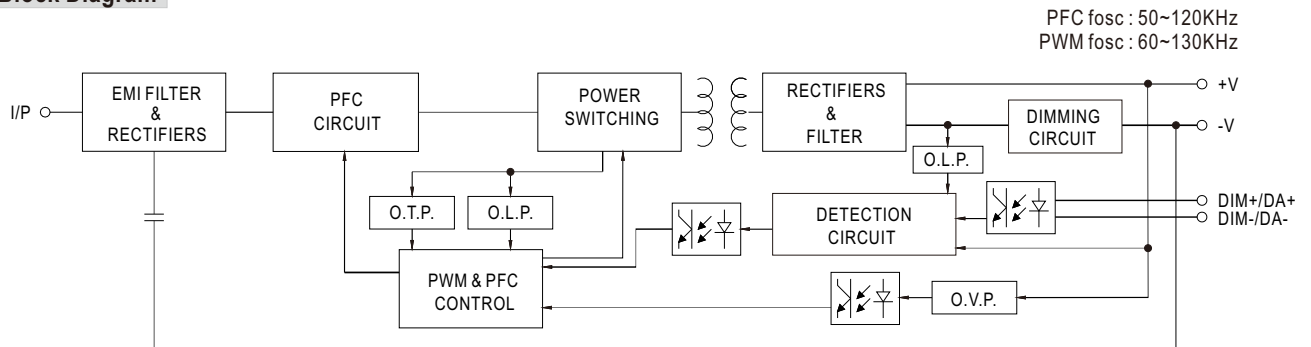

### Mechanical Specification

Case No. PWM-200 Unit:mm

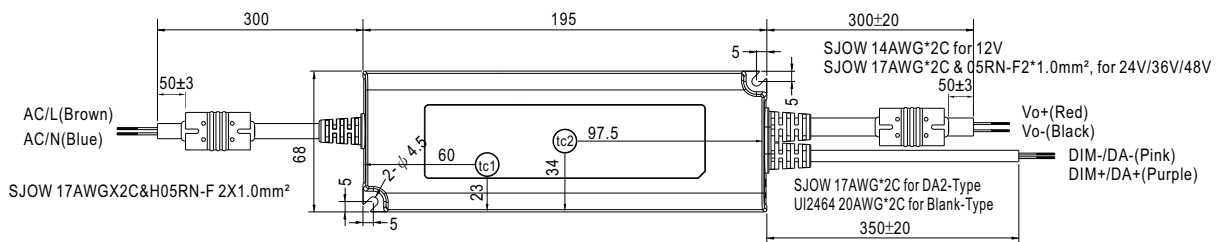

- (tc1) : Max. Case Temperature for Input 110Vac
- (tc2) : Max. Case Temperature for Input 230Vac

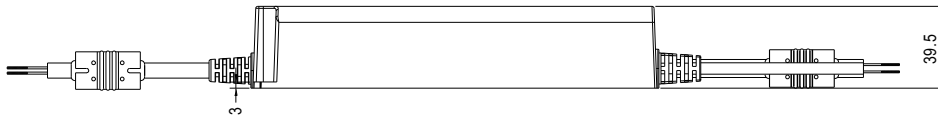

■ **Recommend Mounting Direction**

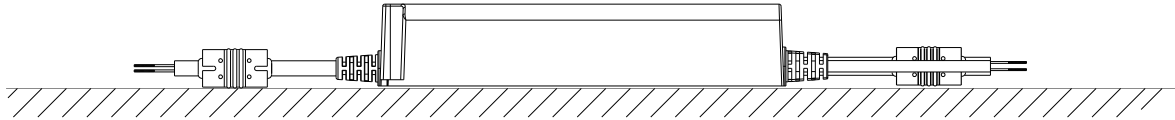

■ **Installation Manual**

◎ **Connection for Blank-type and DA2-type**

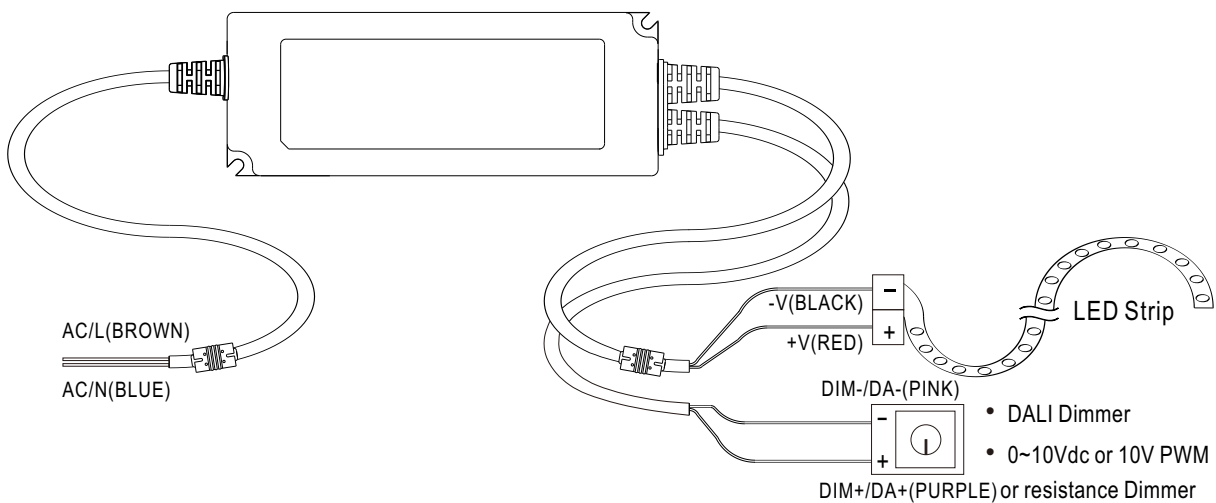

◎ **Cautions**

- Before commencing any installation or maintenance work, please disconnect the power supply from the utility. Ensure that it cannot be re-connected inadvertently!
- Keep proper ventilation around the unit and do not stack any object on it. Also a 10-15 cm clearance must be kept when the adjacent device is a heat source.
- Mounting orientations other than standard orientation or operate under high ambient temperature may increase the internal component temperature and will require a de-rating in output current.
- Current rating of an approved primary /secondary cable should be greater than or equal to that of the unit. Please refer to its specification.
- For LED drivers with waterproof connectors, verify that the linkage between the unit and the lighting fixture is tight so that water cannot intrude into the system.
- For dimmable LED drivers, make sure that your dimming controller is capable of driving these units. PWM series require 0.15mA each unit.
- Tc max. is identified on the product label. Please make sure that temperature of Tc point will not exceed limit.
- Suitable for indoor use or outdoor use without direct sunlight exposure. Please avoid immerse in the water over 30 minutes.
- The power supply is considered as a component that will be operated in combination with final equipment. Since EMC performance will be affected by the complete installation, the final equipment manufacturers must re-qualify EMC Directive on the complete installation again.