

Datasheet



- Reliable leading edge detection of letters, thin packages, poly bags, totes, boxes or other product on roller conveyors
- Mounts between conveyor roller gap to standard hex or round side rail holes with no extra hardware required or on the T-Slot with customer supplied bracket and hardware
- Spring loaded end caps reduce installation and alignment time for reduced labor costs
- Built to order with specified length and beam spacing: 200 mm to up to 1500 mm (8 in to up to 59 in) depending on mounting configuration, with 2 to 7 sensors for maximum flexibility
- Robust aluminum housing, ambient light and ESD resistance for enhanced durability



WARNING:

- **Do not use this device for personnel protection**
- Using this device for personnel protection could result in serious injury or death.
- This device does not include the self-checking redundant circuitry necessary to allow its use in personnel safety applications. A device failure or malfunction can cause either an energized (on) or de-energized (off) output condition.

Models

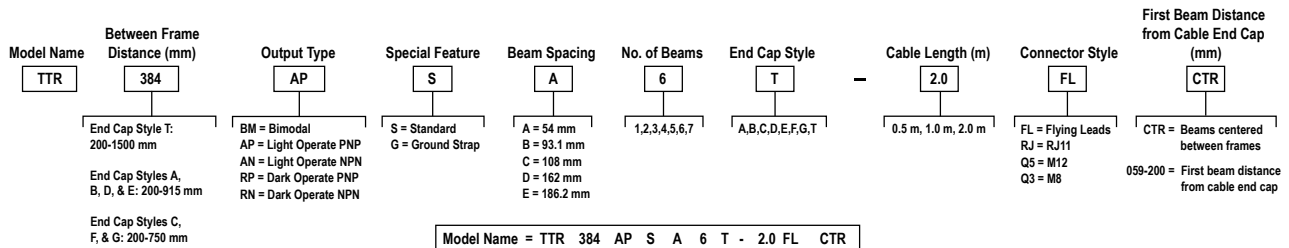

Note: For definition of the End Cap Styles, see [Table 1](#) on p. 2.

Configurations

Figure 1. Spring End Cap Configuration

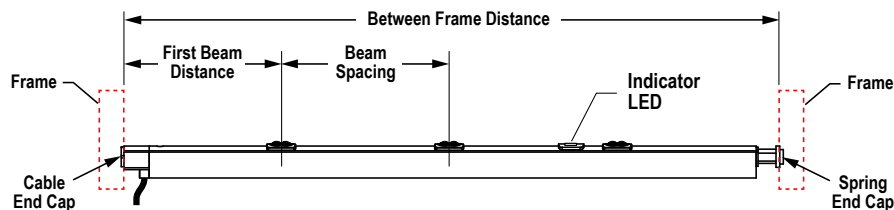

Figure 2. T-Slot Configuration

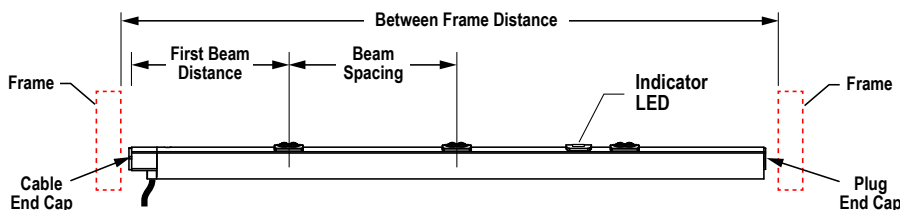

Figure 3. Adhesive End Cap Configuration

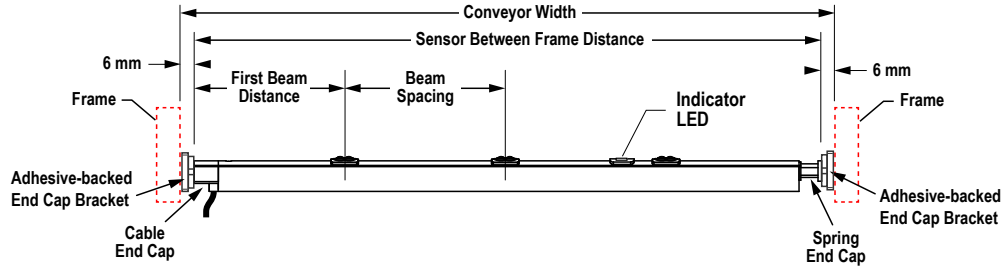

Table 1: End Cap Styles

End Cap Style		End 1		End 2
A	11 mm Hex, flat side up		Spring 11 mm hex / 8 mm round	
B	11 mm Hex, point up		Spring 11 mm hex / 8 mm round	
C	Adjustable 11 mm Hex, can be positioned in 10 degree increments		Spring 11 mm hex / 8 mm round	
D	11 mm Hex, flat side up		Spring 8 mm round	
E	11 mm Hex, point up		Spring 8 mm round	
F	Adjustable 11 mm Hex, can be positioned in 10 degree increments		Spring 8 mm round	
G	Adjustable 11 mm Hex, can be positioned in 10 degree increments / adhesive backed bracket		Spring 11 mm hex / 8 mm round / adhesive backed bracket	
T	11 mm Hex, flat side up		Plug	



Note: T-Slot mounted sensors with the T End Cap Style are 6 mm shorter than the specified Between Frame Distance.

Wiring

Bimodal Output Wiring Diagrams

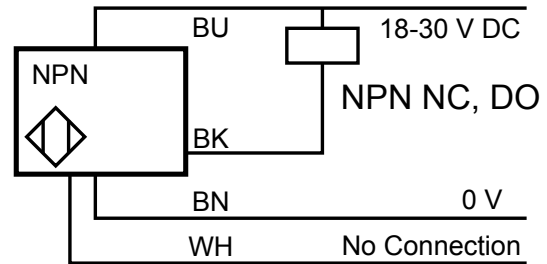
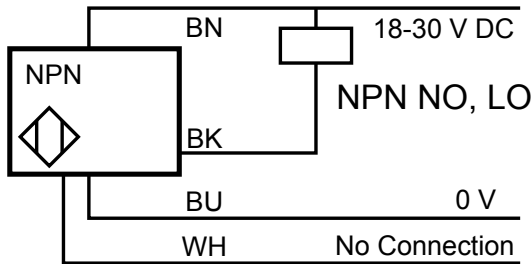
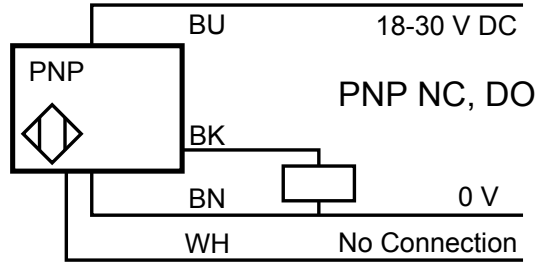
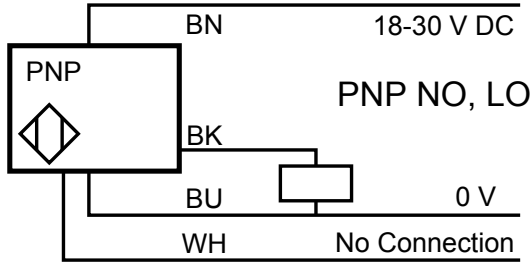

Fixed NPN and PNP Output Wiring Diagrams: Light and Dark Operate by Model Number

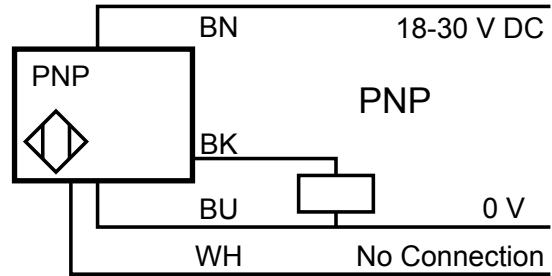
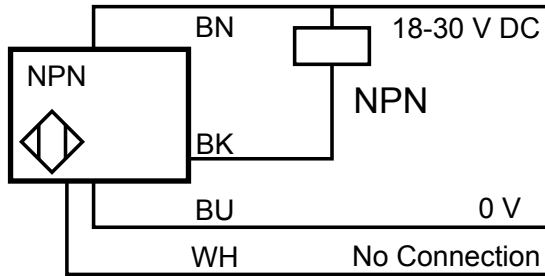

RJ-11 Pinout

RJ-11 Key

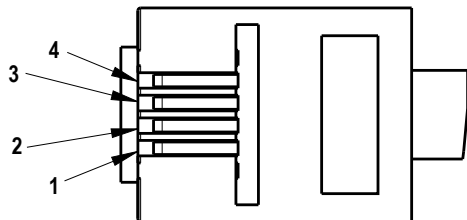

1. Brown
2. Black
3. White
4. Blue

M12 Pinout

M12 Key

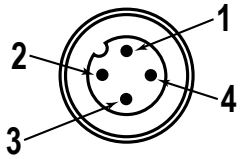

- 1. Brown
- 2. White
- 3. Blue
- 4. Black

M8 Pinout

M8 Key



- 1. Brown
- 2. White
- 3. Blue
- 4. Black

Installation

Mounting Considerations

Conveyor Side View

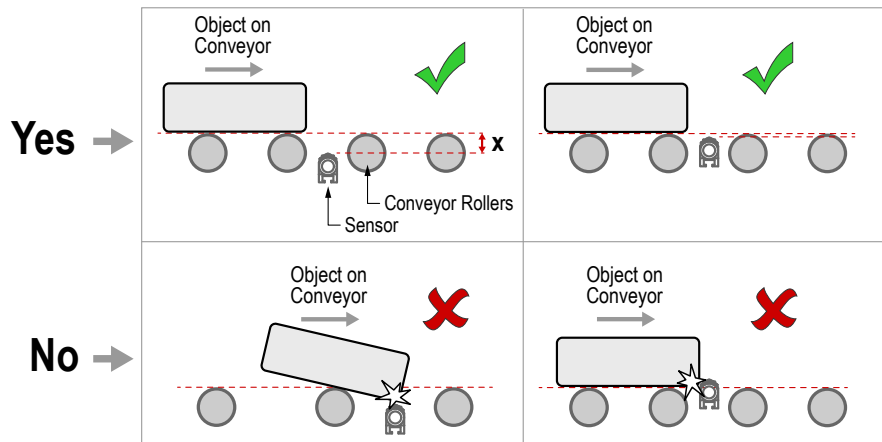

T-Slot Installation

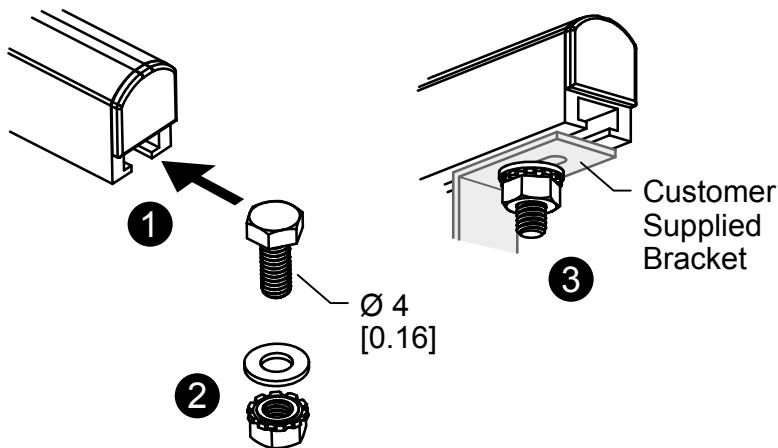

Specifications

Supply Voltage

18 V DC to 30 V DC (24 V nominal with 10% maximum ripple)
Use only with a suitable Class 2 power supply (UL) or SELV power supply (CE)

Supply Current

45 mA

Supply Protection Circuitry

Protected against reverse polarity and transient voltages

Wavelength

Infrared LED, 940 nm

Output Response

1 ms on/off

Output Configuration

Rating: 100 mA max output at 25 °C
Output Voltage High: Greater than Vsupply – 2.5 V
Output Voltage Low: Less than 2.5 V
For loads less than 1 Meg Ohm
Protected against false pulse on power-up and continuous overload or short-circuit of output

Indicators

Amber on: Light sensed

Sensing Mode

Diffuse, Infrared, 940 nm

Range

0 to ≥ 120 mm on 90% white card
0 to ≥ 50 mm on 18% gray card
≤ 3 to ≥ 30 mm on 6% black card

Operating Conditions

–10 °C to +55 °C (+14 °F to +131 °F)

Environmental Rating

IEC IP50

Vibration and Mechanical Shock

All models meet IEC 60068-2-6, IEC 60947-5-2, UL491 Section 40, MIL-STD-202F, Method 201A (Vibration: 10 Hz to 60 Hz, 0.5 mm peak-to-peak)
Shock: 30G 11 ms duration, half sine wave per IEC 60068-2-27

Cable

Minimum static bend radius: 20 mm
Flex life > 10,000 cycles at flexing bend radius > 40 mm

Certifications



Performance Curves

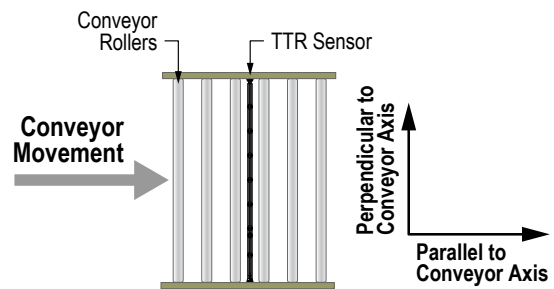
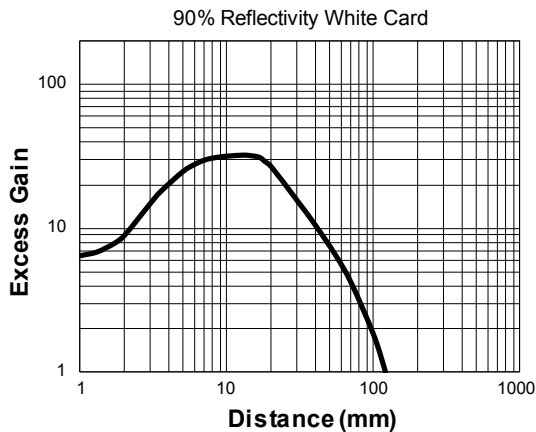
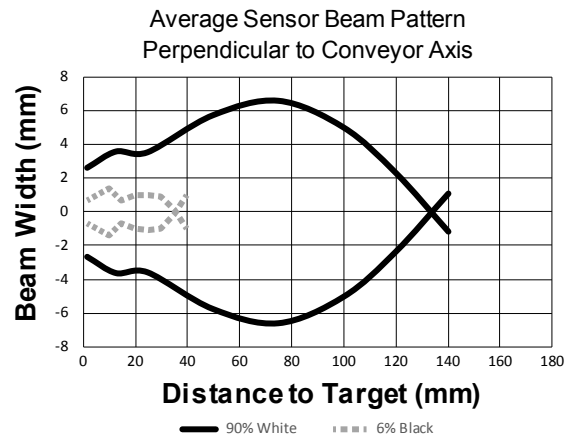
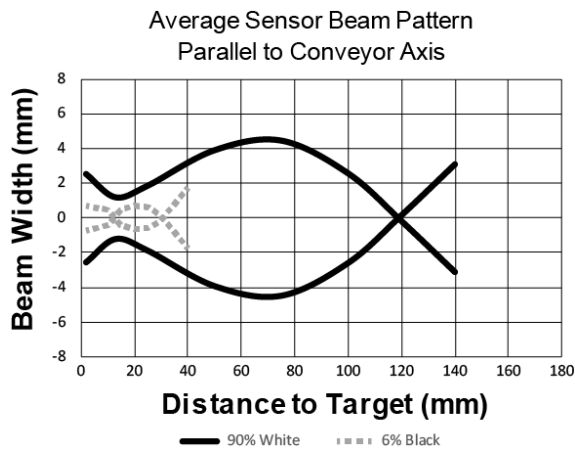

Dimensions

All measurements are listed in millimeters, unless noted otherwise.

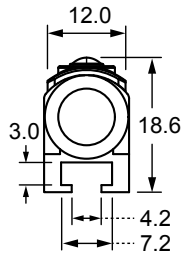

End View

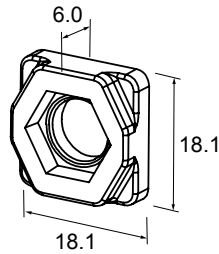

Adhesive End Cap

Accessories

TTR-HK1

- Hardware packet for T-style End-Cap TTRs
- (2) M4 screws
- (2) Hex nuts
- (2) Lock washers

TTR-HK2

- Hardware packet for G-style End-Cap TTRs
- (2) Adhesive backed mounting brackets



Note: Two adhesive backed mounting brackets are included with each G-style sensor. Adhesive backed mounting brackets are also compatible with A-, B-, or C-style sensors.

TTR-HK20

- Hardware packet for G-style End-Cap TTRs
- (20) Adhesive backed mounting brackets



Note: Two adhesive backed mounting brackets are included with each G-style sensor. Adhesive backed mounting brackets are also compatible with A-, B-, or C-style sensors.

Banner Engineering Corp. Limited Warranty

Banner Engineering Corp. warrants its products to be free from defects in material and workmanship for one year following the date of shipment. Banner Engineering Corp. will repair or replace, free of charge, any product of its manufacture which, at the time it is returned to the factory, is found to have been defective during the warranty period. This warranty does not cover damage or liability for misuse, abuse, or the improper application or installation of the Banner product.

THIS LIMITED WARRANTY IS EXCLUSIVE AND IN LIEU OF ALL OTHER WARRANTIES WHETHER EXPRESS OR IMPLIED (INCLUDING, WITHOUT LIMITATION, ANY WARRANTY OF MERCHANTABILITY OR FITNESS FOR A PARTICULAR PURPOSE), AND WHETHER ARISING UNDER COURSE OF PERFORMANCE, COURSE OF DEALING OR TRADE USAGE.

This Warranty is exclusive and limited to repair or, at the discretion of Banner Engineering Corp., replacement. **IN NO EVENT SHALL BANNER ENGINEERING CORP. BE LIABLE TO BUYER OR ANY OTHER PERSON OR ENTITY FOR ANY EXTRA COSTS, EXPENSES, LOSSES, LOSS OF PROFITS, OR ANY INCIDENTAL, CONSEQUENTIAL OR SPECIAL DAMAGES RESULTING FROM ANY PRODUCT DEFECT OR FROM THE USE OR INABILITY TO USE THE PRODUCT, WHETHER ARISING IN CONTRACT OR WARRANTY, STATUTE, TORT, STRICT LIABILITY, NEGLIGENCE, OR OTHERWISE.**

Banner Engineering Corp. reserves the right to change, modify or improve the design of the product without assuming any obligations or liabilities relating to any product previously manufactured by Banner Engineering Corp. Any misuse, abuse, or improper application or installation of this product or use of the product for personal protection applications when the product is identified as not intended for such purposes will void the product warranty. Any modifications to this product without prior express approval by Banner Engineering Corp will void the product warranties. All specifications published in this document are subject to change; Banner reserves the right to modify product specifications or update documentation at any time. Specifications and product information in English supersede that which is provided in any other language. For the most recent version of any documentation, refer to: www.bannerengineering.com.

For patent information, see www.bannerengineering.com/patents.