



LZ2N SERIES

# KILLARK

## NON-METALLIC FLUORESCENT FIXTURES



4' Nominal Style



2' Nominal Style

**Class I, Div. 2 Groups A,B,C,D**  
**Class I, Zones 2, Groups IIC,IIB,IIA**  
**Class II, Div. 1 & 2, Groups F,G**  
**AEx nAll, Ex nAll**  
**Wet Locations**  
**NEMA 4X, IP66**

Certified - File LR11713

**NSF Food Handling**  
**ABS Type Approval**

LZ2N/LZ2S luminaires contain no exposed glass and carry Class II, "G" ratings required for many food processing areas.

**FEATURES-SPECIFICATIONS**

**LINEARLITE®** \*

\* marca registrada MEXICO

**Applications**

LINEARLITE® rugged Non-Metallic fluorescent fixtures are suitable for wet, harsh and hazardous locations. Use where enclosed and gasketed fixtures are required to withstand exposure to moisture, dust and corrosives. The LZ2N Series can also be used in Class I, Division 2 and Zone 2 hazardous vapors and in Class II areas where combustible dusts may exist. Typical areas used are in refineries, chemical plants, waste water & sewage treatment facilities, as well as in tunnels, food processing and coastal areas.

**ABS** (American Bureau of Shipping) type approval for use on decks, vessels, platforms, barges, ships and boats. Also suitable for docks and marinas.

**NSF** (National Sanitation Foundation) approved for "Food Handling" areas, typically requiring non-glass lighting.

**Features**

- Lexan® Clear Lens, impact resistant polycarbonate
- Housing-one piece fiberglass reinforced polyester, NEMA 4X & IP66 rated.
- Two 3/4" NTP aluminum hubs - one at each end (includes one 3/4" close-up plug and two 3/4" x 1/2" reducers for maximum user flexibility)
- Two 1/4"-20 aluminum bushings furnished in top of fixture for threaded rod
- 2' and 4' luminaires
- Lamp types-  
Linear 17, 28, 32, 40, 44, 54, 60W  
Long compact 40, 55W (single ended)
- Electronic ballast standard
- World voltage (most models) 120 thru 277V, 50/60 Hz

Lexan® is a registered trademark of General Electric

Quick release diffuser clamp and hinged cover requires no special tools.

**Catalog Number Logic**

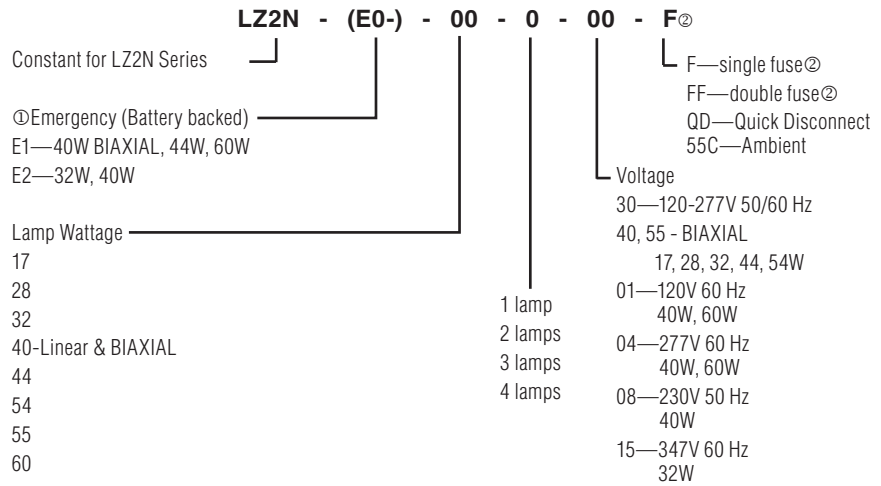

- Ⓞ See page L206 for complete catalog grid listing.
- Ⓞ Fuses not for marine or Canadian use.
- Ⓞ 55°C ambient suitability 2 or 3 lamp 32W C1D2 120V-277V only.

LZ2N, LZ2NE HAZARDOUS LOCATION APPLICATION DATA											
NUMBER OF LAMPS/WATTS	RATED AMBIENT °C	SUITABLE FOR °C SUPPLY WIRE	CLASS I, DIV. 2 MAX. SURFACE TEMP.			CLASS II, DIV. 1 & 2 MAX. SURFACE TEMP.			CLASS III DIV. 1 & 2 SUITABILITY	NEMA 4X IP66	
			TEMP.	T-CODE	GROUPS	TEMP.	T-CODE	GROUPS			
2 X 17W	40°	60	85°C	T5	A, B, C, D	100°C	T5	F, G	Yes	Yes	
3 X 17W	40°	60	85°C	T5	A, B, C, D	100°C	T5	F, G	Yes	Yes	
1 X 40W BIAxIAL	40°	60	100°C	T5	A, B, C, D	100°C	T5	F, G	Yes	Yes	
1 X 55W BIAxIAL	40°	60	160°C	T3C	A, B, C, D	100°C	T5	F, G	Yes	Yes	
2 X 40W BIAxIAL	40°	60	100°C	T5	A, B, C, D	100°C	T5	F, G	Yes	Yes	
4 X 40WBIAxIAL	40°	60	120°C	T4A	A, B, C, D	100°C	T5	F, G	Yes	Yes	
2 X 28W	40°	60	120°C	T4A	A, B, C, D	100°C	T5	F, G	Yes	Yes	
3 X 28W	40°	60	120°C	T4A	A, B, C, D	100°C	T5	F, G	Yes	Yes	
2 X 32W	40°	75	85°C	T6	A, B, C, D	100°C	T5	F, G	Yes	Yes	
2 X 32W	55°Ⓞ	90	100°C	T5	A, B, C, D	N/A	N/A	N/A	Yes	Yes	
3 X 32W	40°	75	85°C	T6	A, B, C, D	100°C	T5	F, G	Yes	Yes	
3 X 32W	55°Ⓞ	90	100°C	T5	A, B, C, D	N/A	N/A	N/A	Yes	Yes	
2 X 40W	40°	60	120°C	T4A	A, B, C, D	100°C	T5	F, G	Yes	Yes	
2 X 44W	40°	60	100°C	T5	A, B, C, D	100°C	T5	F, G	Yes	Yes	
2 X 54W T5	40°	75	160°C	T3C	A, B, C, D	100°C	T5	F, G	Yes	Yes	
3 X 54W T5	40°	75	180°C	T3A	A, B, C, D	120°C	T4A	F, G	Yes	Yes	
2 X 60W	40°	75	135°C	T4	A, B, C, D	100°C	T5	F, G	Yes	Yes	

# LIGHTING

LZ2N SERIES



## NON-METALLIC FLUORESCENT FIXTURES

LZ2N NON-METALLIC			
NUMBER OF LAMPS/WATTS	VOLTAGE AC 60 HZ	DESCRIPTION	LZ2N
<b>BIAXIAL LAMP TYPE FIXTURES</b>			
1-40W	120-277V	2' 1-Lamp Biaxial Electronic 50/60 Hz 0°F Start 4-Pin	LZ2N40130
1-55W	120-277V	2' 1-Lamp Biaxial Electronic 50/60 Hz 0°F Start 4-Pin	LZ2N55130
2-40W	120-277V	2' 2-Lamp Biaxial Electronic 50/60 Hz 0°F Start 4-Pin	LZ2N40230
4-40W	120-277V	4' 4-Lamp Biaxial Electronic 50/60 Hz 0°F Start 4-Pin	LZ2N40430
<b>DOUBLE-ENDED LAMP TYPE FIXTURES</b>			
2-17W	120-277V	2' 2-Lamp T8 Electronic 50/60 Hz 0°F Start Medium Bi-Pin	LZ2N17230
3-17W	120-277V	2' 3-Lamp T8 Electronic 50/60 Hz 0°F Start Medium Bi-Pin	LZ2N17330
2-28W	120-277V	4' 2-Lamp T-5 Electronic 50/60 Hz 0°F Start Miniature Bi-Pin	LZ2N28230
3-28W	120-277V	4' 3-Lamp T-5 Electronic 50/60 Hz 0°F Start Miniature Bi-Pin	LZ2N28330
2-32W	120-277V 347V	4' 2-Lamp T-8 Electronic 50/60 Hz 0°F Start Medium Bi-Pin	LZ2N32230 <sup>④</sup> LZ2N32215
3-32W	120-277V 347V	4' 3-Lamp T-8 Electronic 50/60 Hz 0°F Start Medium Bi-Pin	LZ2N32330 <sup>④</sup> LZ2N32315
2-40W	120V 277V 230V 50 Hz <sup>②</sup>	4' 2-Lamp T-12 Electronic, Medium Bi-Pin Start 50°F 40W/60°F 34W	LZ2N40201 LZ2N40204 LZ2N40208
2-44W	120-277V	4' 2-Lamp T-8 Electronic -20°F Start High Output 50/60 Hz Recessed Double Contact	LZ2N44230
2-54W	120-277V	4' 2-Lamp T-5 Electronic 50/60 Hz -20°F Start Miniature Bi-Pin	LZ2N54230
3-54W	120-277V	4' 2-Lamp T-5 Electronic 50/60 Hz -20°F Start Miniature Bi-Pin	LZ2N54330
2-60W	120-277V	4' 2-Lamp T-12 Electronic -20°F Start High Output 50/60 Hz Recessed Double Contact	LZ2N60230

See page L208 for LZ2NE Non-metallic and LZ2SE 316 Stainless Emergency Models

LZ2N AND LZ2S BALLAST DATA <sup>①</sup>					
NUMBER OF LAMPS / WATTS	VOLTAGE	LINE CURRENT AMPS		INPUT WATTS	STARTING TEMPERATURE
1 X 40W BIAXIAL	120-277V	.35 (120V)	.15 (277V)	39	0°F (-18°C)
1 X 55W BIAXIAL	120-277V	.49 (120V)	.22 (277V)	58	0°F (-18°C)
2 X 40W BIAXIAL	120-277V	.60 (120V)	.28 (277V)	78	0°F (-18°C)
4 X 40W BIAXIAL	120-277V	1.32 (120V)	.56 (277V)	156	0°F (-18°C)
2 X 17W	120-277V	.32 (120V)	.14 (277V)	38	0°F (-18°C)
3 X 17W	120-277V	.39 (120V)	.17 (277V)	48	0°F (-18°C)
2 X 28W	120-277V	.55 (120V)	.23 (277V)	66	0°F (-18°C)
3 X 28W	120-277V	.83 (120V)	.35 (277V)	99	0°F (-18°C)
2 X 32W	120-277V	.54 (120V)	.24 (277V)	65	0°F (-18°C)
3 X 32W	120-277V	.71 (120V)	.31 (277V)	85	0°F (-18°C)
2 X 40W	120-277V	.62 (120V)	.24 (277V)	71	50°F (10°C) I
2 X 44W	120-277V	.84 (120V)	.36 (277V)	99	-20°F (-29°C)
2 X 54W	120-277V	1.00 (120V)	.43 (277V)	120	-20°F (-29°C)
3 X 54W	120-277V	1.52 (120V)	.66 (277V)	182	-20°F (-29°C)
2 X 60W	120-277V	1.13 (120V)	.48 (277V)	125	-20°F (-29°C)

<sup>①</sup> Includes normal powered LZ2NE and LZ2SE models, lamps not included.

<sup>②</sup> Magnetic ballast.

<sup>③</sup> 50°C 34T12; 60°F 40T12.

<sup>④</sup> See LOGIC for 55°C ambient suitability.



## DIMENSIONS, ACCESSORIES

### Dimensions LZ2N, LZ2NE Series

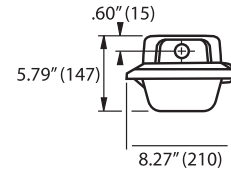
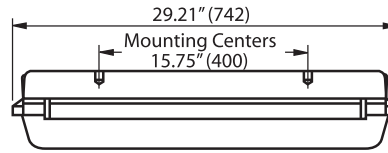
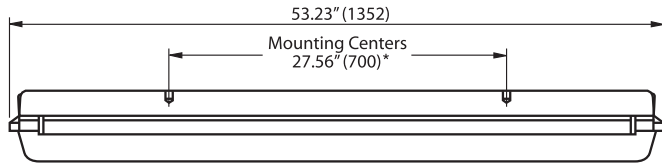

\* Mounting Centers are 1/4"-20" tapped for user all thread rod or below accessories.

### Mounting Accessories for all LZ2N, LZ2S Series

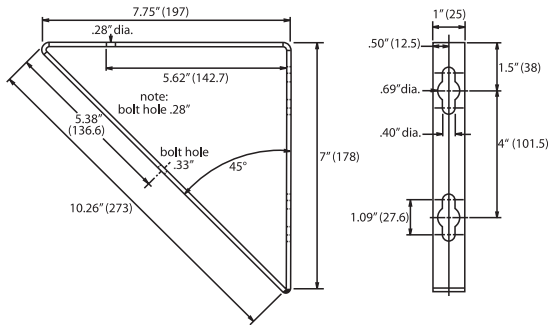

**Wall Bracket Set<sup>2</sup>**  
**Part Number LZWB**  
 Stainless Steel (natural finish)

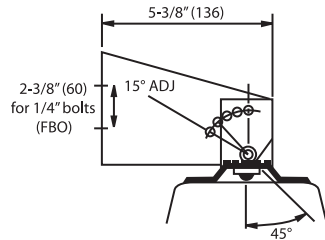

**Adjustable Wall Bracket Set<sup>2</sup>**  
**Part Number LZAB**  
 Stainless Steel bracket with ceramic coated pivot bolt

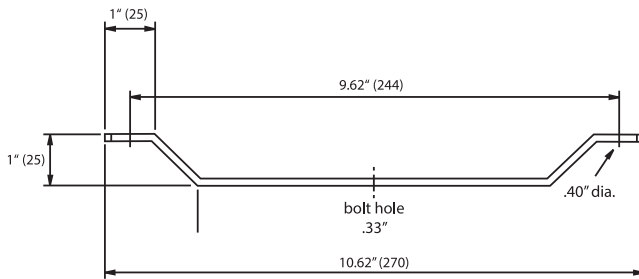

**Ceiling Bracket Set<sup>2</sup>**  
**Part Number LZCB**  
 Stainless Steel (natural finish)

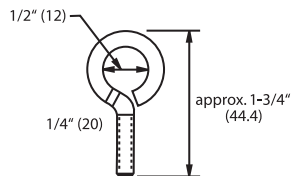

**Eyebolt Set**  
**Part Number LZEB**  
 Stainless Steel bolt with lockwasher & nut (natural finish)

**Suspension Chains (2 required)**  
**Part Number HFX-SC**  
 36" length plated steel chain with snap link ends. For use with LZEB

<sup>1</sup> Dimensions in ( ) are millimeters.  
<sup>2</sup> Product accessories have hardware for attachment to fixture; hardware to attach to wall/ceiling F.B.O.  
 NOTE: Eyebolts are 316 Series, brackets are 300 Series Stainless Steel.

REPLACEMENT PARTS:	
LZ2N4LENS	4' Lens only LZ2N/LZ2S
LZ2N2LENS	2' Lens only LZ2N/LZ2S
LZ2N4BAR	4' Locking Bar only LZ2N
LZ2N2BAR	2' Locking Bar only LZ2N
LZ2S-LATCH	Latch and Spring