



LOAD CONTROL

Application Guide

Energy Efficiency Products

Hubbell Load Control Solutions

Electric bill impact for a typical office building*

Lighting Uses 39% of Total Electricity

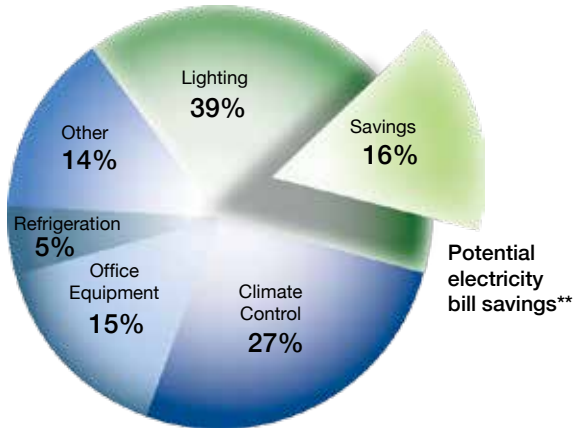

Note: *Energy Information Administration:
- Commercial Buildings
- Energy Consumption Survey

**Based on 40% lighting savings from sensors. Actual results may vary.

Costs and Maintenance

Lighting consumes as much as 40% of a typical commercial building's energy costs, but Hubbell Load Control Solutions use advanced technology to bring this number down. Energy costs can be reduced by between 13% and 90%, offering a significant return on investment (ROI).

In addition to occupancy sensors, Hubbell Load:Logic® family of control devices offers a broad range of controls that meet the latest codes and standards and contribute to LEED certification points. An easy setup and operation process offers an "install-and-forget" experience.

Additional features include:

- Occupancy or time-based controls
- Manual ON mode automatically turns lights OFF when a space is unoccupied for a specified period of time
- Photo sensors control for dimming or to keep the lights OFF when natural light is sensed

Adaptive Technology Provides Better Control

Hubbell's patented breakthrough in advanced control feature smart microprocessors constantly monitoring the controlled area and adjust the sensitivity and timer based on environmental history.

- Lower energy costs and utility bills
- No need to manually adjust for occupancy changes

Backed by Hubbell Service and Support

Hubbell's Load Control Solutions are part of Hubbell's Sustainability Initiative, which focuses on environmental stewardship, innovative products and efficient building operations. Hubbell also offers superior service and support with:

- Online worksheets for calculating energy savings and ROI
- Detailed online e-learning courses
- Product selection guide to assist in choosing the right technology
- Online specification assistance
- Comprehensive layout and take-off services
- Highly knowledgeable network of trained professionals and staff
- BIM models and 3D coverage patterns

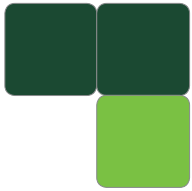

The Right Technology for the Right Application

Passive Infrared (PIR)



Requires a clear, unobstructed line of sight for detection, because it senses occupancy as movement of heat emitted from the body against the background space. A segmented Fresnel lens divides a coverage area into zones. Movement across zones is interpreted as occupancy.

Ultrasonic (US)



Senses occupancy by emitting an ultrasonic high-frequency sound wave (32 kHz to 45 kHz), sensing the frequency of the reflected signal, and then determining occupancy based on a change in frequency. While this has a limited range, it detects small motions and does not require a clear line of sight.

Dual Technology



Combines PIR and US technology, minimizing the risk of lights turning ON when the space is unoccupied. Once occupancy is detected by both technologies within the space lights are turned ON, only one technology is necessary to keep the lights ON.

Table of Contents

Features

Wired vs. Wireless.....	4
Automatic Receptacle Control	5

Design Guides

Office	6
Restroom	8
Classroom.....	10
Laboratory.....	12
Hospitality	14
Warehouse.....	16
HVAC Integration.....	18
Stairwell.....	19

Ordering Information

Wall Switch, Ceiling and Wall Mount Sensors	20
Daylight Harvesting, Wireless Sensors, Permanently Marked Receptacles and Control Units	21

Coverage Patterns

Wall Switch, Ceiling and Wall Mount Sensors	22
Wireless, High Bay and Outdoor Sensors	23

Wiring Diagrams

Wall Switch and High Bay Sensors	24
Ceiling and Receptacle Control Sensors	25

Codes and Standards Reference Table

CEC T24 2016.....	26
ASHRAE 90.1 - 2013.....	27

Typical Applications

Application		Sensor Technology				Sensor Style		
		Adaptive	Dual	Ultrasonic	PIR	Wall Switch	Ceiling	Wall
Office	Small	✓	✓		✓	✓		
	Large	✓	✓	✓			✓	
Open Office		✓	✓	✓			✓	
Rest Room	Small			✓	✓	✓	✓	
	Large	✓		✓			✓	
Classroom	Small	✓	✓			✓	✓	
	Large	✓	✓				✓	
Conference Room	Small	✓	✓			✓	✓	
	Large	✓	✓				✓	
Storage/Warehouse	Small				✓	✓		
	Large	✓			✓		✓	✓
Hall		✓		✓	✓		✓	✓

Wired or Wireless Sensors

What is the right choice?

Both choices offer advantages and selecting the most suitable one is key to a successful energy control strategy.

New construction, retrofit applications, construction materials, type of space to be controlled, etc. play a role in the selection process.



Wired

Wired technology has been available for over 50 years and is traditionally used when there is no restriction for running wires. It also offers more choices of sensing technologies.

Wired technology is:

- The preferred choice for new construction, as wiring can be run easily while construction is underway.
- Offers more technologies; passive infrared, ultrasonic and dual.
- Easily interfaces with other technologies and control systems like wireless, building automation and HVAC.

Wired Controls' New Companion

Hubbell's WL Series wireless controls can be installed to work with Hubbell's traditional wired technology to provide an optimal solution when running extra wiring is difficult or impractical.

vs.

Wireless

The WL Series sensors are designed for ultra-low power consumption which translates into a ten year battery life. They also combine advanced Digital Signal Processing (DSP) with Passive Infrared (PIR) technology to maximize sensitivity to the movement of heat emitted from people occupying a space.

Commands are transmitted up to 60 feet over the low interference 434MHz band to associated Clear Connect® enabled devices that automatically turn lights OFF and other non-essential loads.

Wireless technology is:

- Flexible, making moves, additions and changes easy because there is no need for additional wiring.
- Fast to install and setup, typically involves replacing the existing wall switch and pairing the desired sensor.
- These controls utilize a simplified 6-second press and hold commissioning procedure. No need for remotes, computers, smartphones or any other device to set up the system.

Automatic Receptacle Control

Hubbell Load Controls *Manage More than Just the Lights*



Designers and manufacturers have been implementing solutions to reduce the power consumption of lighting and HVAC systems for decades. Office equipment, appliances and plug in lighting loads are the next major target area for reduction of energy consumption. When left ON, these devices increase energy costs and a building's carbon

footprint. As a result, codes and standards now mandate that a number of electrical receptacles in certain spaces be automatically controlled to reduce the likelihood of occupants forgetting to turn lights OFF or unplug equipment.

Load:Logic® Control Panels

These panels are a cost effective solution to achieve code compliance in small office buildings, retail, motel and warehouse applications. They provide centralized intelligence and also work as part of a hybrid control system.

- Save time with low voltage devices that connect directly to the panel.
- Panels meet ASHRAE 90.1, IEEC and California (CEC) Title 24 energy codes.
- Lower setup and maintenance costs with expanded programming and pre-programmed options to reduce consumption for each control zone. Integrated astronomical clock eliminates the need for roof mounted photocells.



Occupancy-Based Control

Occupancy sensors are already required in most applications to control lighting. These same sensors can be utilized to control electrical receptacles. This minimizes the installation cost and provides a control method that adapts easily to how the space being monitored is actually being used.

Time-Based Control

Time schedule based control is preferred for applications where devices need to be ON at defined periods. This can include schools, hospitality and office building applications.

Codes and Standards

ASHRAE 90.1



ASHRAE 90.1 is the leading energy building efficiency standard for commercial buildings in North America. Section 8.4.2, ASHRAE 90.1-2010 instituted the requirement that in certain spaces at least 50% of all receptacles are to be controlled by either time of day control device, an occupancy sensor or by an automated signal from another control or alarm system.

LEED v4



The latest version of the US Green Building Council's LEED rating system mandates compliance to all mandatory provisions in ASHRAE 90.1-2013. This includes the electrical receptacle control requirement.

California Energy Commission Title 24



Section 130.5(d) of California Energy Commission Title 24, Part 6 - 2013 code requires receptacles to have automatic shutoff controls in certain spaces in all buildings.

NEC 2014



Article 406.3(E) of the NEC® 2014 edition selected the standby (Ⓢ) symbol as the marking for a receptacle connected to an automatic control system.

For more details about Automatic Receptacle Control (ARC), see the Hubbell Load:Logic® ARC Guide available on our website, or contact your Hubbell Territory Manager for a printed copy.

Office Design Guide



Flexible work hours, telecommuting, hoteling and adaptable workspaces mean that modern offices experience constant changes in occupancy patterns. If your lighting system has not been modernized to accommodate this trend, you are most likely wasting energy and money in unoccupied spaces as employees come and go throughout the week. Incorporating a daylight harvesting strategy to benefit from advancements in Solid State Lighting (SSL) is becoming common practice to save even more in energy costs.

Individual Office | Wired Approach



Lighting Control

- Wall Switch Sensor: **AD2000** Series or **WS2000** Series
- Dimming Wall Switch: **APD2000** Series (Requires 0–10V dimming ballast/driver)
- Dimming Photocell: **DHADC** (Requires 0–10V dimming ballast/driver)

Automatic Receptacle Control

- Receiver: **CU300HD**
- Controlled Receptacles: **BR15C1** - Half Controlled, **DR15C1** - Half Controlled

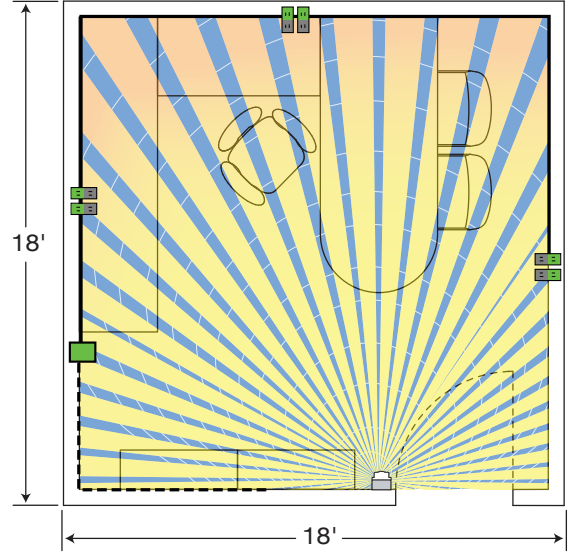

Individual Office | Wireless Approach



Lighting Control

- Wireless Ceiling Sensor: **WLP450C**
- Wireless Wall Switch: **WLS1278** Series
- Daylight Sensor: **WLDH**

Automatic Receptacle Control

- Receiver: **WLC301**
- Controlled Receptacles: **BR15C1** - Half Controlled, **DR15C1** - Half Controlled

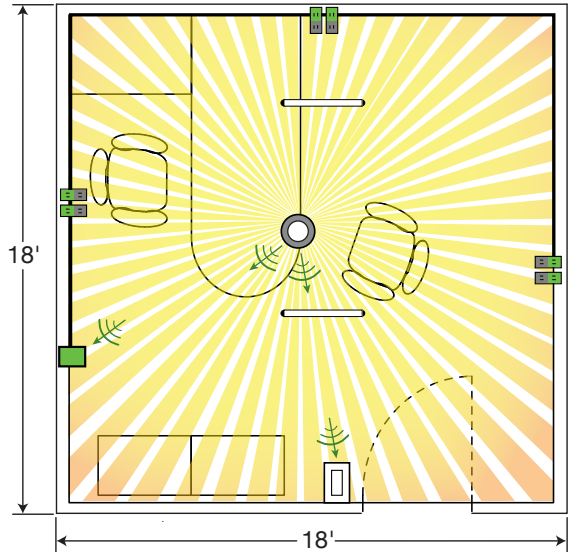

LEGEND

- Ceiling Sensor
- Wall Sensor
- Wall Switch
- Receiver
- Wireless Signal
- Wireless Transmitter
- Permanently Marked Receptacles
 - Fully Controlled
 - Half Controlled
 - Uncontrolled

COVERAGE PATTERN

- Minor/Major Motion
 - Ultrasonic
 - Passive Infrared (PIR)

These diagrams visually represent occupancy sensor design recommendations based on specific spaces in different building types.

Open Office | Wired Approach



Lighting Control

- Ceiling Sensor:
ATD2000C
Control Unit required:
CU300A
- Dimming Photocell:
DHADC
(Requires 0–10V dimming ballast/driver)

Automatic Receptacle Control

- Receiver:
CU300HD
- Controlled Receptacles:
BR15C2 - Fully Controlled
DR15C2 - Fully Controlled

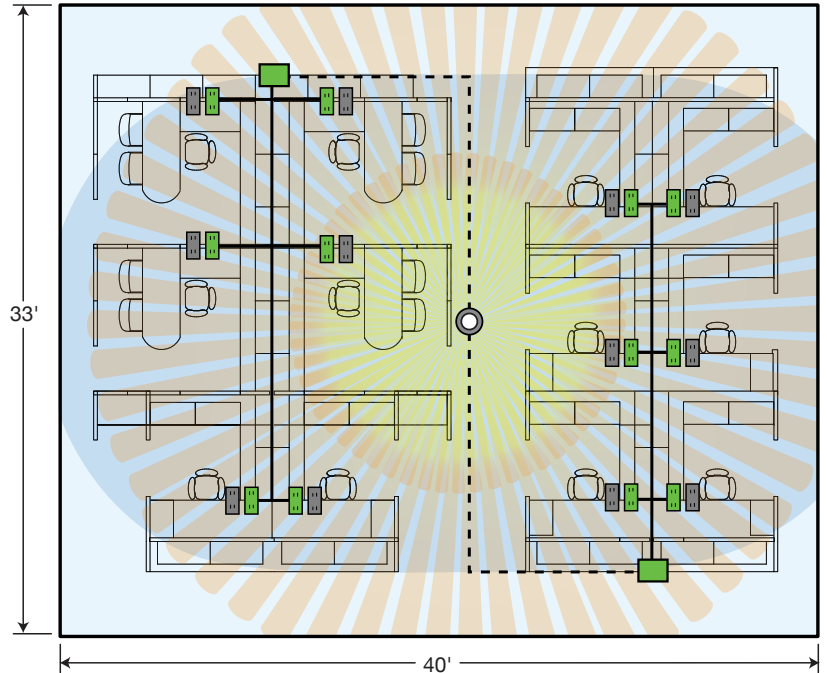

Open Office | Wireless Approach



Lighting Control

- Ceiling Sensor:
ATD2000C
Control Unit required:
CU300A
- Wireless Transmitter:
WLCA
- Dimming Photocell:
DHADC
(Requires 0–10V dimming ballast/driver)

Automatic Receptacle Control

- Receiver:
WLC402W
- Controlled Receptacles:
BR15C2 - Fully Controlled
DR15C2 - Fully Controlled

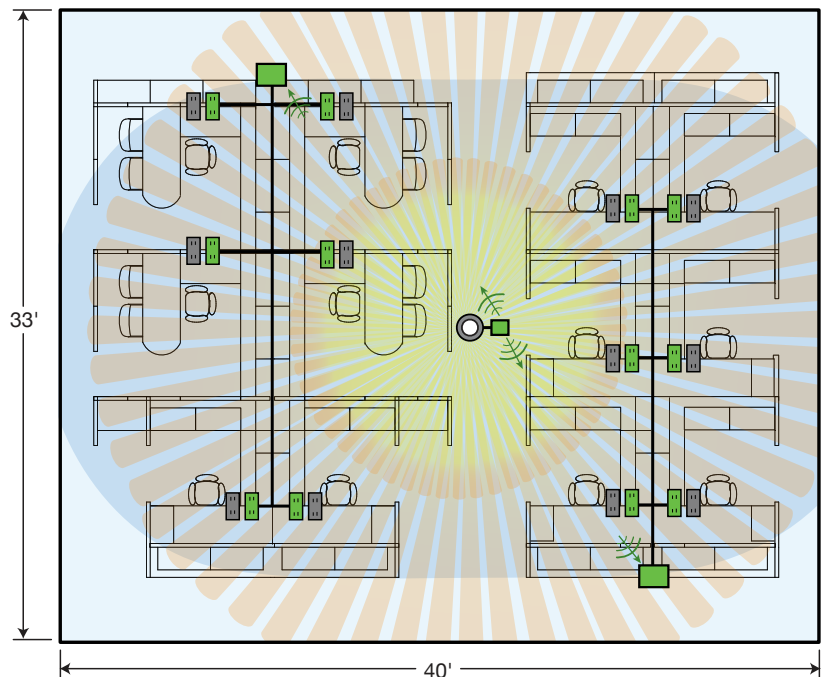

These diagrams visually represent occupancy sensor design recommendations based on specific spaces in different building types.

Restroom Design Guide



Restrooms are typically occupied less than 50% of the day, but lights are often left ON all the time. Significant savings can be achieved by using Hubbell Occupancy Sensors to automatically turn lights ON when someone enters the restroom, and turn them OFF after the occupant leaves. The sensors also eliminate light switches as a restroom component that must be touched on the way out the door, helping improve hygiene.



Hubbell Occupancy Sensors with dual circuit capabilities allow for integrated functionality while maintaining independent timer control of lights and exhaust fans. This simplifies installation and demonstrates a practical approach for the application. Are the lights ON in your building's restroom right now?

LEGEND

-  Ceiling Sensor
-  Wall Sensor
-  Wall Switch
-  Exhaust Fan
-  Wireless Signal

COVERAGE PATTERN

Minor/Major Motion

-  Ultrasonic
-  Passive Infrared (PIR)

Small Private Restroom | Wired Approach



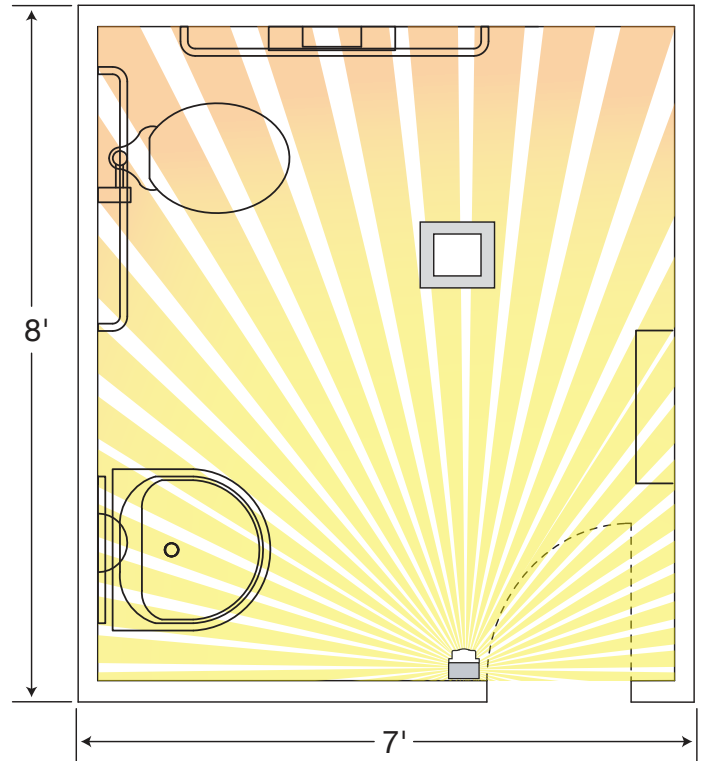

Lighting Control

-  Wall Switch Sensors:
 - WS1020 Series** - Dual relay and independent control for fans
 - WS2000 Series** - Dual voltage, single relay
 - AP2000 Series** - Single or dual relay, adaptive technology



Wireless Approach

-  Wireless Ceiling Sensor:
WLP450C
-  Wireless Wall Switch:
WL1278 Series



Optional receiver unit for fan control:
WLC316R

Large Public Restroom | Wired Approach



ATU500C

CU300A

ATU2000CL

Lighting Control

- Ceiling Sensor:
ATU500C
- Control Unit required:
CU300A
- or
- ATU2000CL**
- No Control Unit required

Optional auxiliary unit for exhaust fan control: **AAR20P**

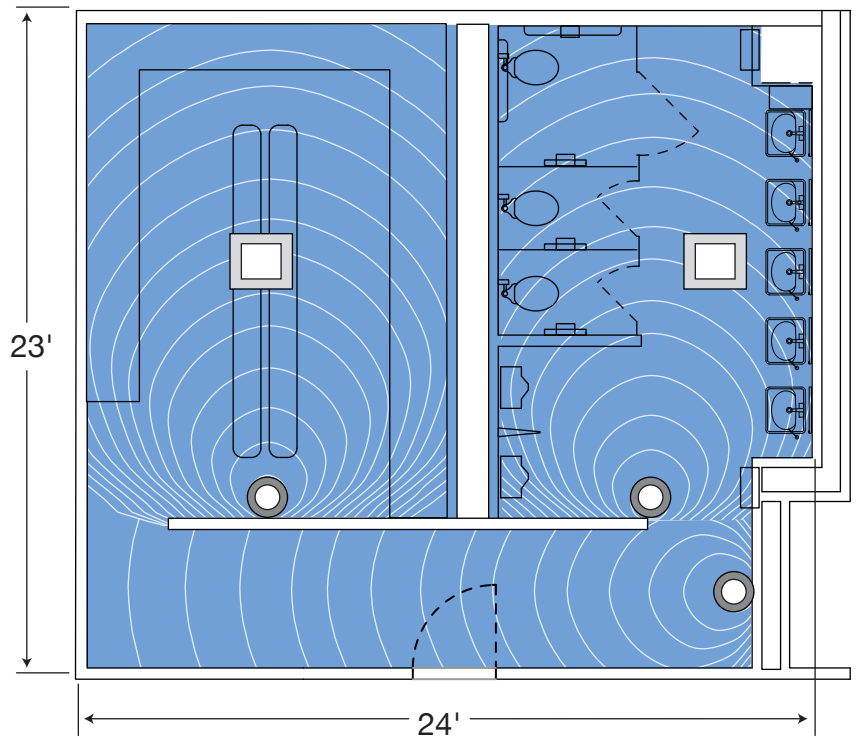

Large Public Restroom | Wireless Approach



WLP450C

WLC316R

WLS1278W

Occupancy Sensor

- Wireless Ceiling Sensor:
WLP450C
- Wireless Control Unit required:
WLC316R

- Optional Override Switch:
WLS1278 Series

Optional receiver unit for fan control: **WLC301**

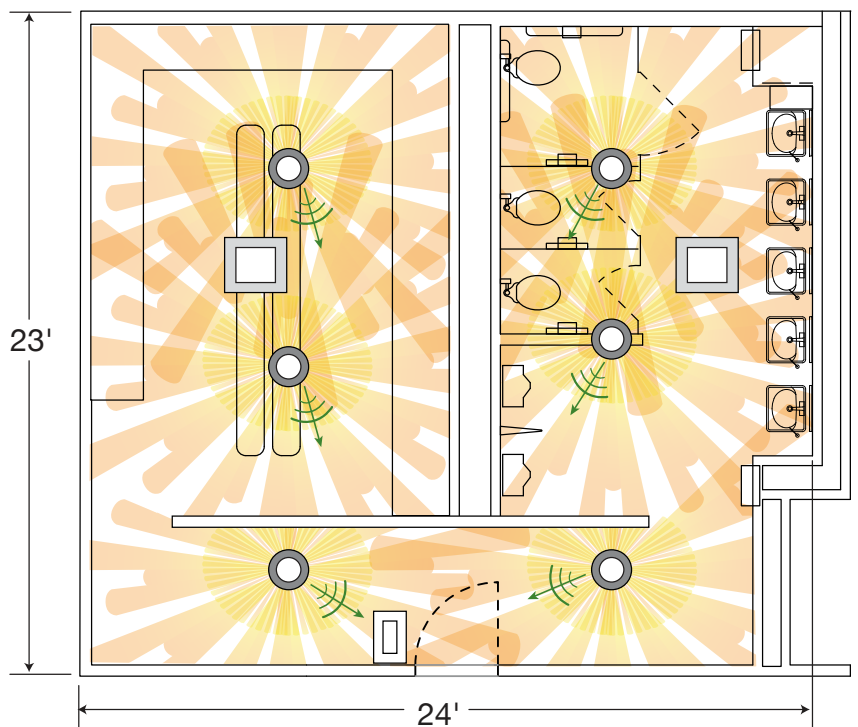

These diagrams visually represent occupancy sensor design recommendations based on specific spaces in different building types.

Classroom Design Guide



With the constant buzz of activity involving students and teachers who are in and out of classrooms all day, making sure the lights are turned OFF when the room is empty is a challenge. Occupancy sensors provide an inexpensive way to guarantee that energy waste is kept to a minimum so teachers can focus on teaching instead of making sure lights, monitors, TV screens, projectors and other systems are OFF.

Optional photo sensors can also be used to turn lights OFF in classrooms when enough natural light is detected in the space, allowing the use of natural daylight. The Adaptive Technology used in Hubbell's Occupancy Sensors adjusts to the occupancy and environmental changes caused by school-day activities and after-school programs, as well as field trips, holidays and cancellations.

LEGEND

Ceiling Sensor

Wall Switch

Receiver

Wireless Signal

Permanently Marked Receptacles

Fully Controlled

Half Controlled

COVERAGE PATTERN

Minor/Major Motion

Ultrasonic

Passive Infrared (PIR)

Library | Wireless Approach



Lighting Control

Wireless Ceiling Sensor:
WLP450C

Wireless Control Unit required:
WLC316R

Optional Override Switch:
WLS1278 Series

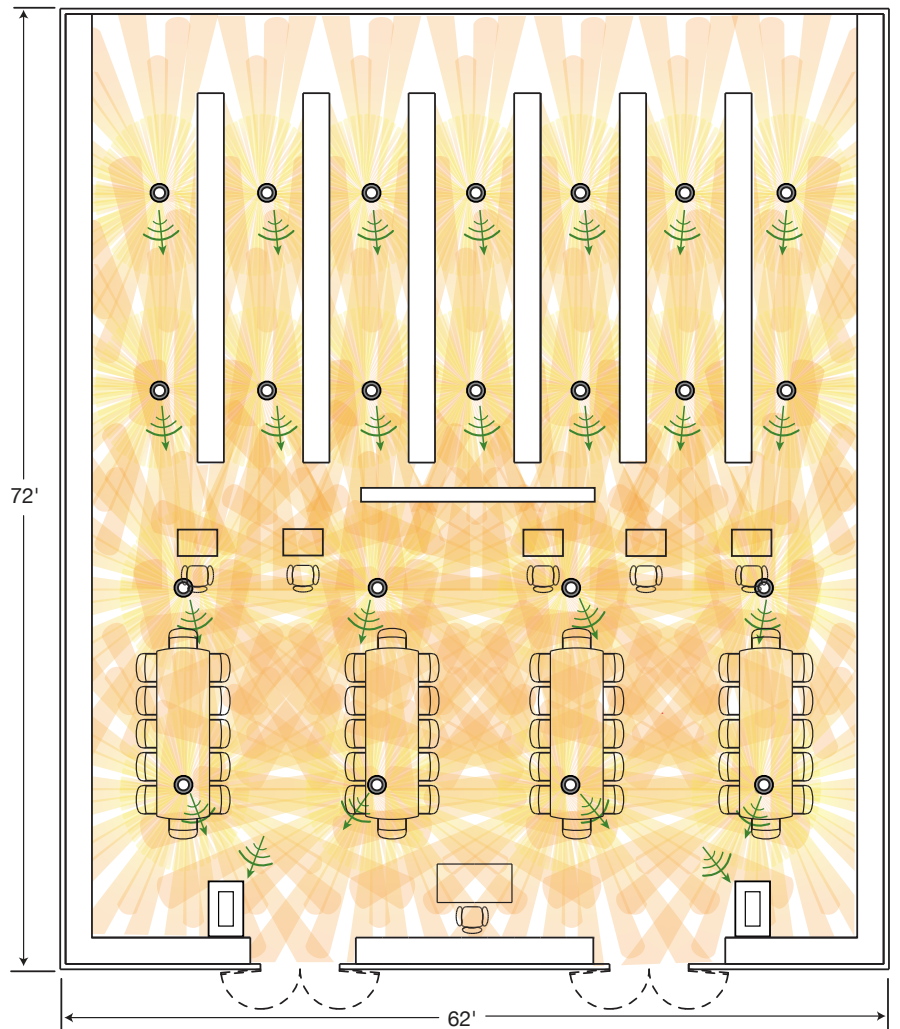

These diagrams visually represent occupancy sensor design recommendations based on specific spaces in different building types.

Large Classroom | Wired Approach



Lighting Control

- Ceiling Sensor:
ATD2000C

Control Units:

- CU300A** - Auto ON
- CU300M** - Manual ON
- DSM30 Series** - Manual ON Switch

Automatic Receptacle Control

- Receiver:
CU300HD
AAR20P

- Controlled Receptacles:
BR15C1 - Half Controlled
BR20C1 - Half Controlled

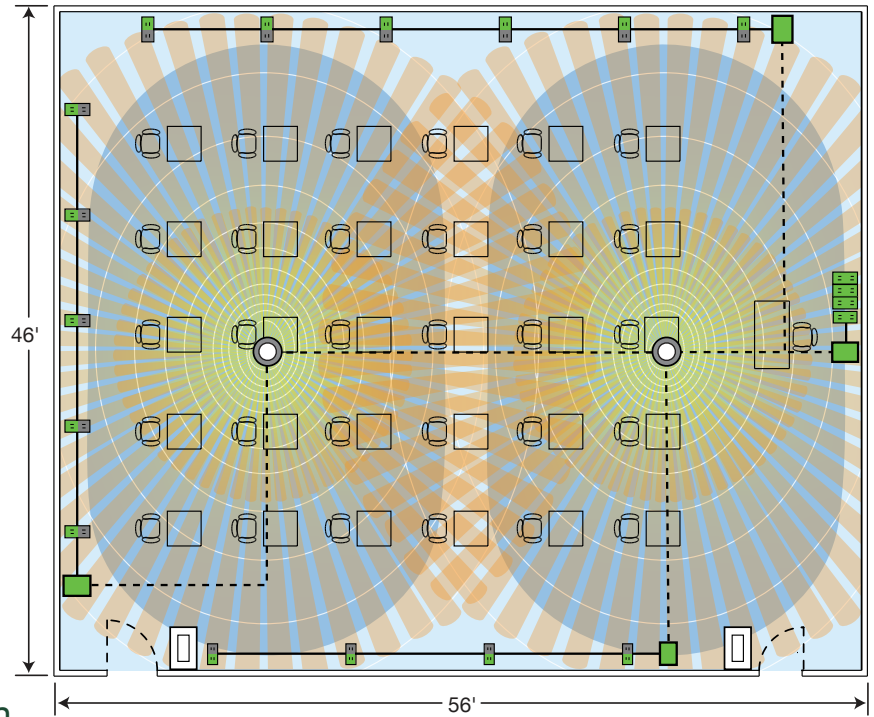

Large Classroom | Wireless Approach



Lighting Control

- Wireless Ceiling Sensor:
WLP450C

- Wireless Wall Switch:
WLS1278 Series

Automatic Receptacle Control

- Receiver:
WLC301
WLC302

- Controlled Receptacles:
BR15C1 - Half Controlled
BR20C1 - Half Controlled

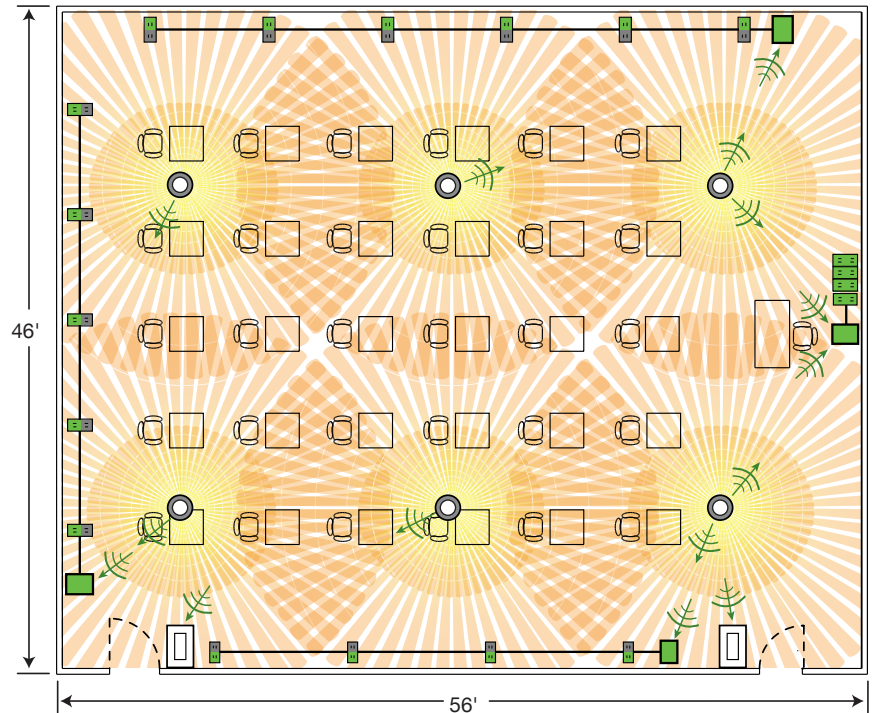

These diagrams visually represent occupancy sensor design recommendations based on specific spaces in different building types.

Laboratory Design Guide



Laboratory spaces are enclosed environments unlike any other. Technicians and scientists often have their hands full dealing with sensitive equipment, harsh chemicals or biomaterials—they may want to avoid touching a light switch in a clean environment. Occupancy Sensors ensure that lab occupants do not have to deal with the lights turning OFF at an inopportune moment.

Hubbell specialized occupancy sensor enclosures are ideal for keeping particulate exposure to a minimum. The enclosures' smooth surface can be easily cleaned and it will not compromise the sterile environment of a typical research or educational laboratory.

LEGEND

Ceiling Sensor

Wall Switch

Exhaust Fan

Receiver

Wireless Signal

Permanently Marked Receptacles

Half Controlled

COVERAGE PATTERN

Minor/Major Motion

Ultrasonic

Passive Infrared (PIR)

Research Laboratory | Wired Approach



Lighting Control

Ceiling Sensor:
ATP1500C

Control Units:

CU300A - Auto ON

CU300M - Manual ON

DSM30 Series - Manual ON Switch

NEMA 4X Enclosure

ACIPE

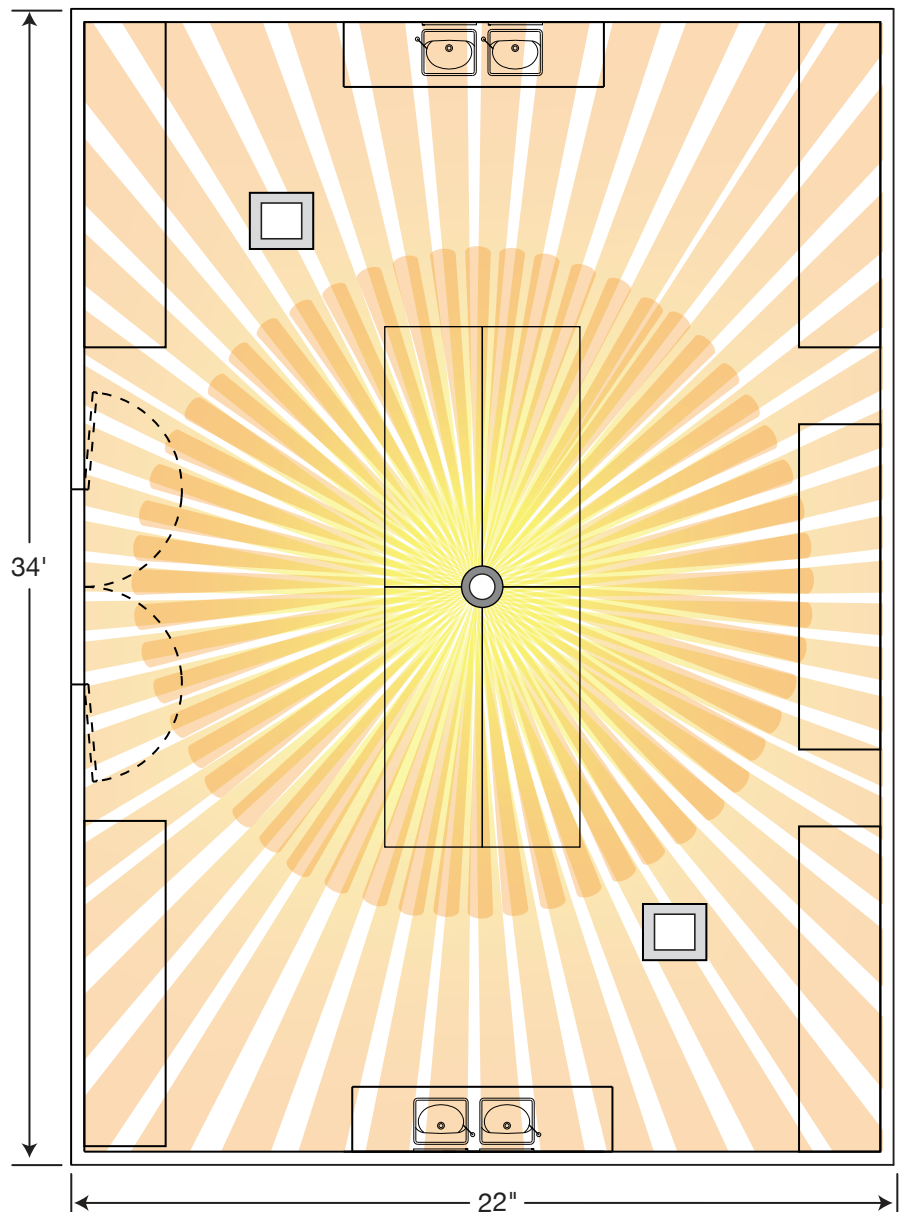

These diagrams visually represent occupancy sensor design recommendations based on specific spaces in different building types.

Computer Lab | Wired Approach



Lighting Control

- Ceiling Sensor:
ATD2000C

Control Units:

- CU300A** - Auto ON
- CU300M** - Manual ON
- DSM30 Series** - Manual ON Switch

Automatic Receptacle Control

- Receiver:
CU300HD

- Controlled Receptacles,
Split Circuit (One controlled
and one not):
BR20C1 - Half Controlled
DR20C1 - Half Controlled

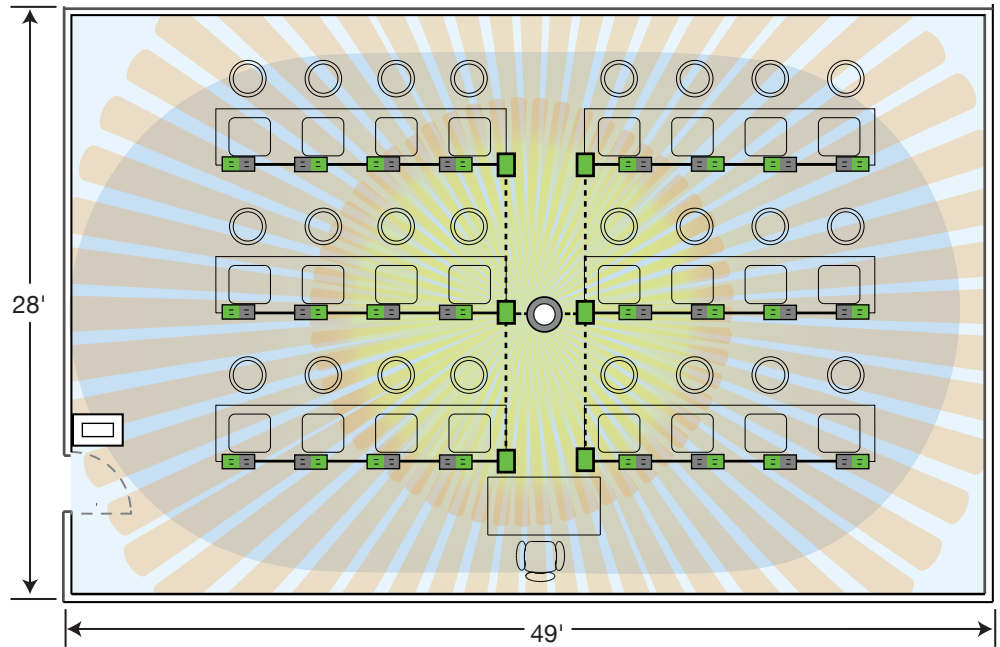

Computer Lab | Wireless Approach



Lighting Control

- Wireless Ceiling Sensor:
WLP450C
- Wireless Control Unit required:
WLC316R
- or
Wireless Wall Switch:
WLS1278 Series

Automatic Receptacle Control

- Receiver:
WLC301

- Controlled Receptacles,
Split Circuit (One controlled
and one not):
BR20C1 - Half Controlled
DR20C1 - Half Controlled

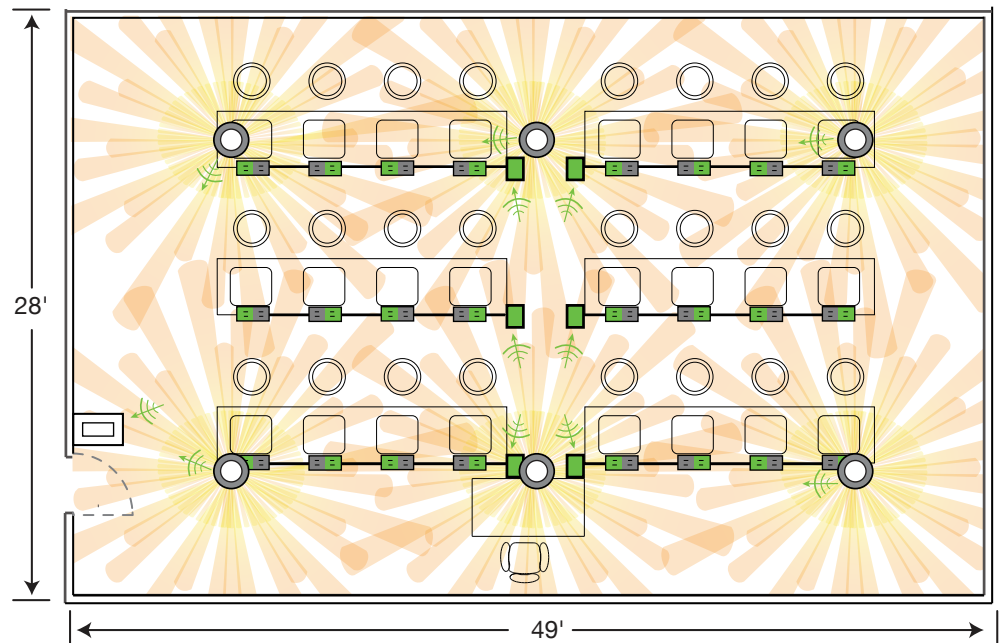

These diagrams visually represent occupancy sensor design recommendations based on specific spaces in different building types.

Hotel Room Design Guide



Hotel guestroom occupancy is never predictable and, even when occupied, each room has different lighting needs, based upon who is using the space and behavior. Occupancy sensor controls can not only reduce energy consumption in unoccupied guestrooms, but also ensure that hotel staff do not need to manually turn OFF lights when the room is not in use. By reducing lighting energy costs, hotel management can spend the savings elsewhere—on a guestroom refresh, updated technology, or additional green building projects.

Hotel Room | Wired Approach

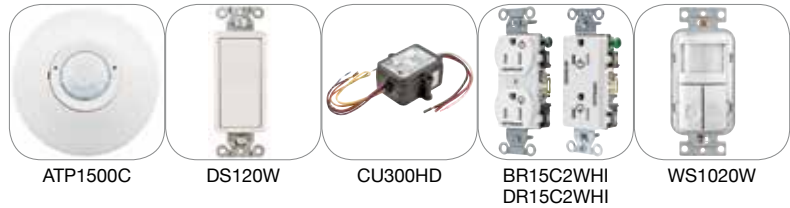

Main Room

Lighting Control

- Ceiling Sensor: **ATP1500C**
- Control Unit required: **CU300A**

- Override Wall Switch: **DS120 Series**

Automatic Receptacle Control

- Receiver: **CU300HD**
- Controlled Receptacles:
 - BR15C2** - Fully Controlled
 - DR15C2** - Fully Controlled

Bathroom

Lighting Control

- Wall Switch Sensors:
 - WS1020 Series**
 - WS1000 Series**
 - WS2000 Series**

LEGEND

- Ceiling Sensor
- Wall Sensor
- Wall Switch
- Exhaust Fan
- Receiver
- Wireless Signal
- Permanently Marked Receptacles
 - Fully Controlled
 - Uncontrolled

COVERAGE PATTERN

- Minor/Major Motion
 - Ultrasonic
 - Passive Infrared (PIR)

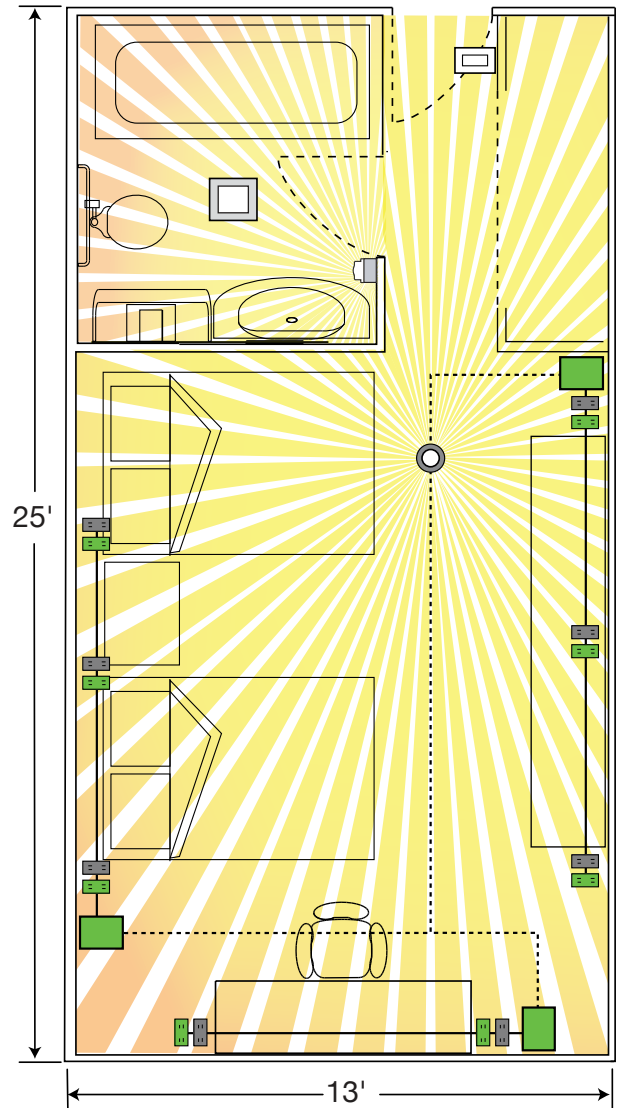

These diagrams visually represent occupancy sensor design recommendations based on specific spaces in different building types.

Hotel Room | Wireless Approach



Main Room

Lighting Control

- Wireless Ceiling Sensor:
WLP450C
- Wireless Control Unit required:
WLC316R
- or
□ Wireless Wall Switch:
WLS1278 Series

Automatic Receptacle Control

- Receiver:
WLC301
- Controlled Receptacles:
BR15C2 - Fully Controlled
DR15C2 - Fully Controlled

Bathroom (Wired)

Lighting Control

- Wall Switch Sensors:
WS1000 Series
WS2000 Series
WS1020 Series

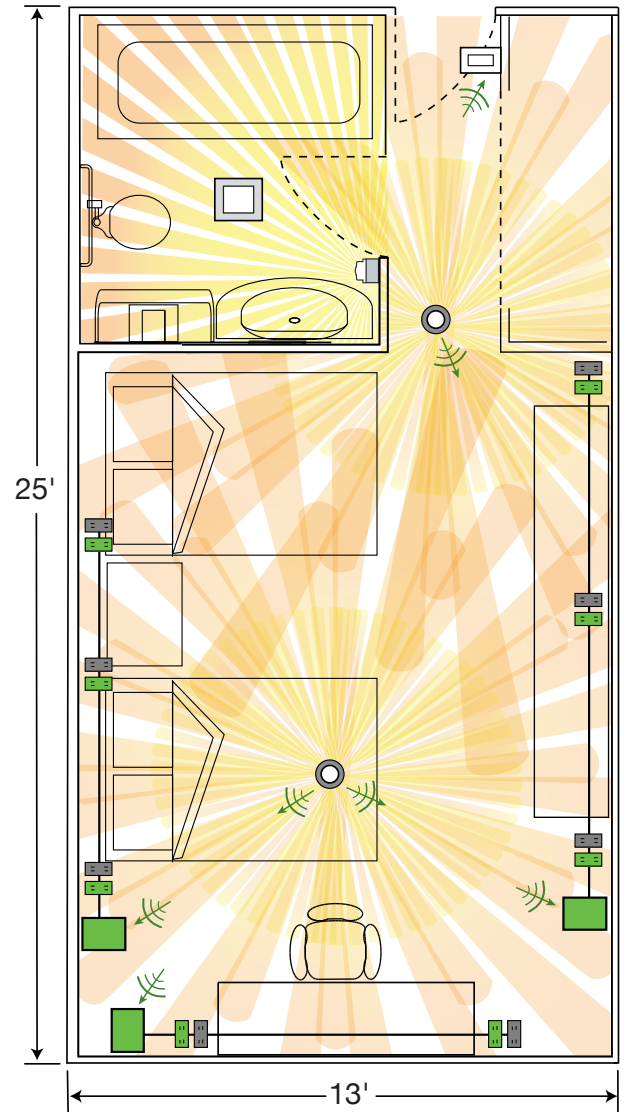

Closet | Wired Approach



Lighting Control

- Wall Switch Sensors:
WS1000 Series - Single voltage, single relay
WS2000 Series - Dual voltage, single relay
AP2000 Series - Single or dual relay, adaptive technology

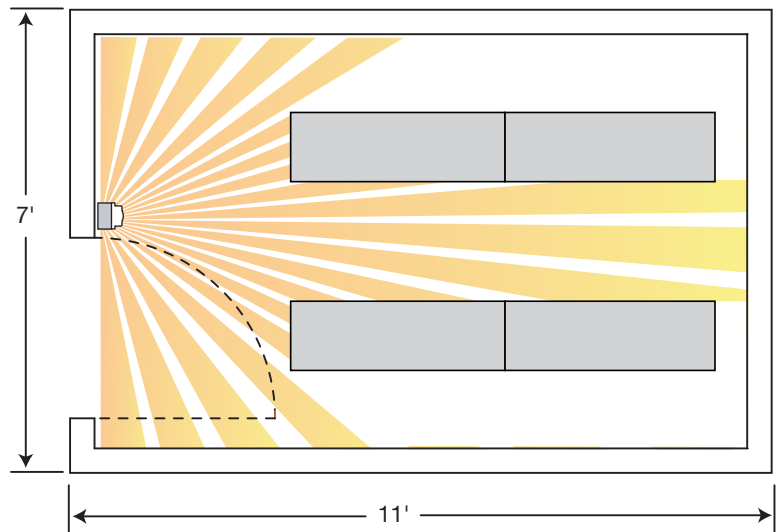

These diagrams visually represent occupancy sensor design recommendations based on specific spaces in different building types.



Warehouse Design Guide





Warehouse applications can be very challenging. Traffic patterns, working hours, the presence of skylights and code compliance are fundamental when selecting the appropriate design technique. Occupancy sensors will ensure that only areas that are being used are illuminated.

The main challenge in a warehouse is the possibility of false triggering in aisles where there is no real occupancy as people walk near the entrances of these aisles. A successful layout will involve carefully taking into account the coverage patterns and placement of the sensors to avoid false triggering.

LEGEND

-  Fixture Mount Sensor
-  Outdoor Sensor

COVERAGE PATTERN

- Minor/Major Motion 
- Passive Infrared (PIR) 

Warehouse | Wired Approach



HMHB2x9
HMHB2xxPCWD



AHP1600WRP

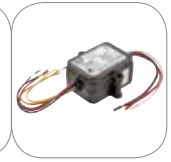

CU300HD

Indoor

Lighting Control

-  Fixture Mount Sensor: **HMHB2x9 Series**
- Dimming Series: **HMHB2xxPCWD**
- Replacement Lenses: 8–16 ft. use Low Bay; **HMLBLxxx** lens
- 18–45 ft. use High Bay; **HMHBLxxx** lens

Outdoor

Lighting Control

-  Outdoor Sensor: H-MOSS®|MAXX™ **AHP1600WRP Series**
-  Control Unit: **CU300HD**

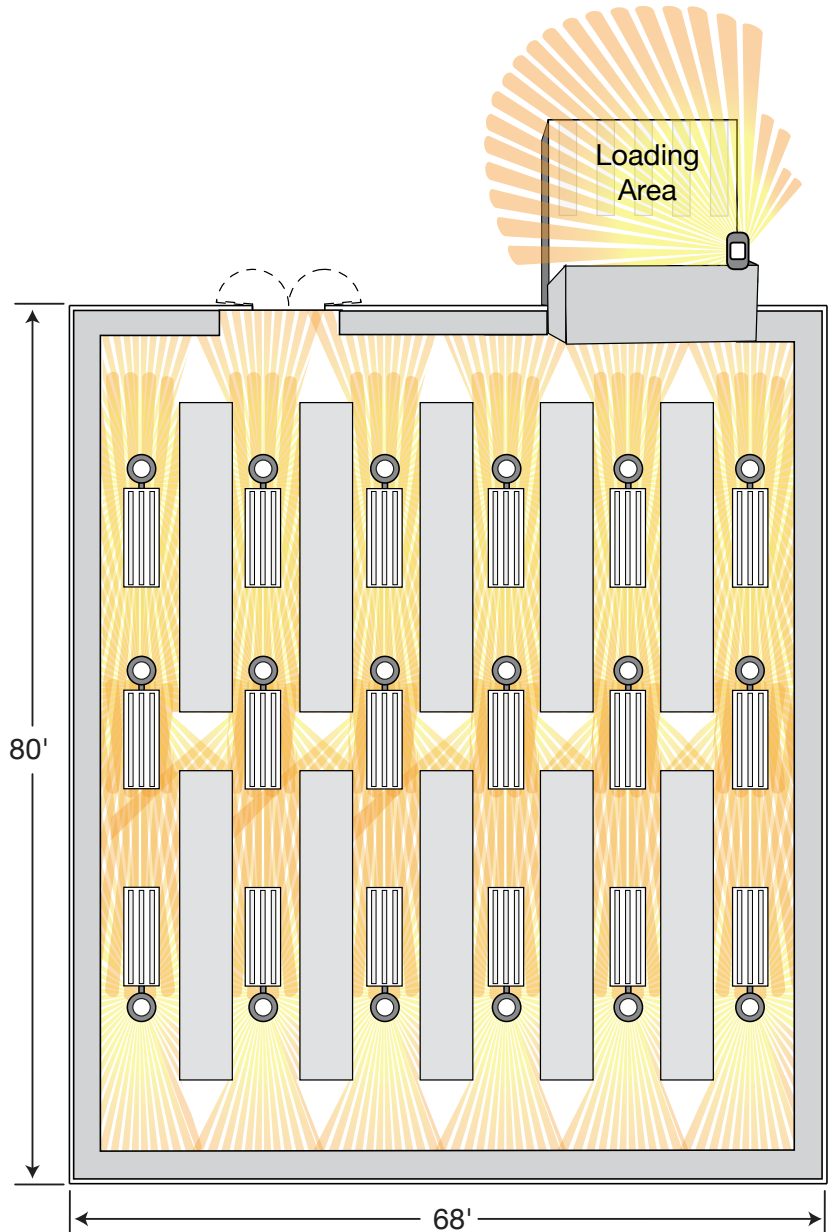

These diagrams visually represent occupancy sensor design recommendations based on specific spaces in different building types.

Warehouse Design Guide



When work schedules and occupancy patterns in a warehouse are reasonably defined, a centralized or a hybrid method of control may be considered.

Depending on the warehouse size, a load control panel may be needed as a centralized control point or to complement occupancy sensors with dimming capabilities.

The control panel also provides a significant reduction in setup and maintenance costs because it provides many pre-programmed options and astronomical clock.

This approach addresses code and standards requirements like demand response.

Warehouse | Time-Based Approach



CP082RRR1

Indoor

Lighting Control

Load:Logic® Control Panels:
 (1ea) **CP082RRR1** 8-relay panel with 8 spaces for field installed relays (6ea) **R21HN** Electrically held, 20A 1P relay

Optional Accessories if adding dimming capabilities
 Requires compatible 0-10V dimming ballasts/LED drivers

(1ea) **CPDM8CTRB** 8-channel dimming controller board
 (2ea) **CPSD3xx** 3-button dimming switch



AHP1600WRP

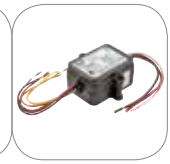

CU300HD

Outdoor

Lighting Control

Outdoor Sensor:
 H-MOSS®/MAXX™
AHP1600WRP Series

Control Unit:
CU300HD

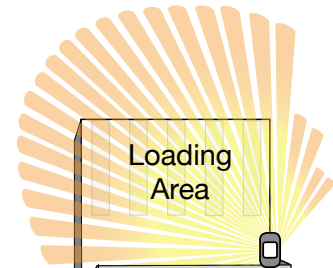

Time-Based Control

Time schedule based control is preferred for applications where devices need to be ON at defined periods. This can include schools, hospitality and warehouse applications.

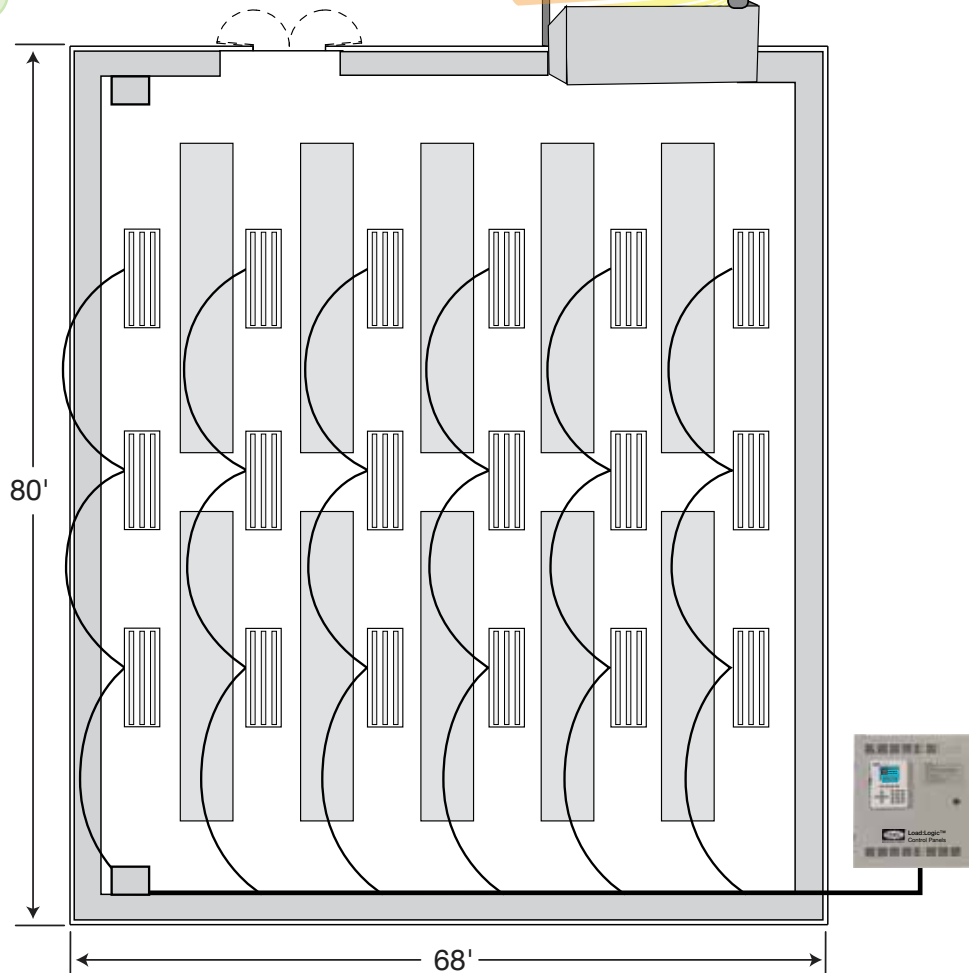

These diagrams visually represent occupancy sensor design recommendations based on specific spaces in different building types.

HVAC Integration



Hubbell sensors can interact with HVAC systems, activating damper controllers in a room based on occupancy, reducing heating and cooling consumption costs. Select the "RP" (Relay and Photocell) option on ceiling and wall mount sensors. This option is available in the WL316R Wireless Control Unit.

HVAC Integration | Wireless Approach



Lighting Control

Wireless Ceiling Sensor:
WLP450C

Wireless Control Unit:
WL316R

Optional Wireless Wall Switch:
WLS1278 Series

Wired Approach



Adaptive Technology

ATD, ATP and ATU Series ceiling/wall mount sensors with RP option

Ceiling Sensor:
ATP600CRP

Control Units:
CU300A - Auto ON
CU300M - Manual ON
DSM30 Series - Manual ON Switch

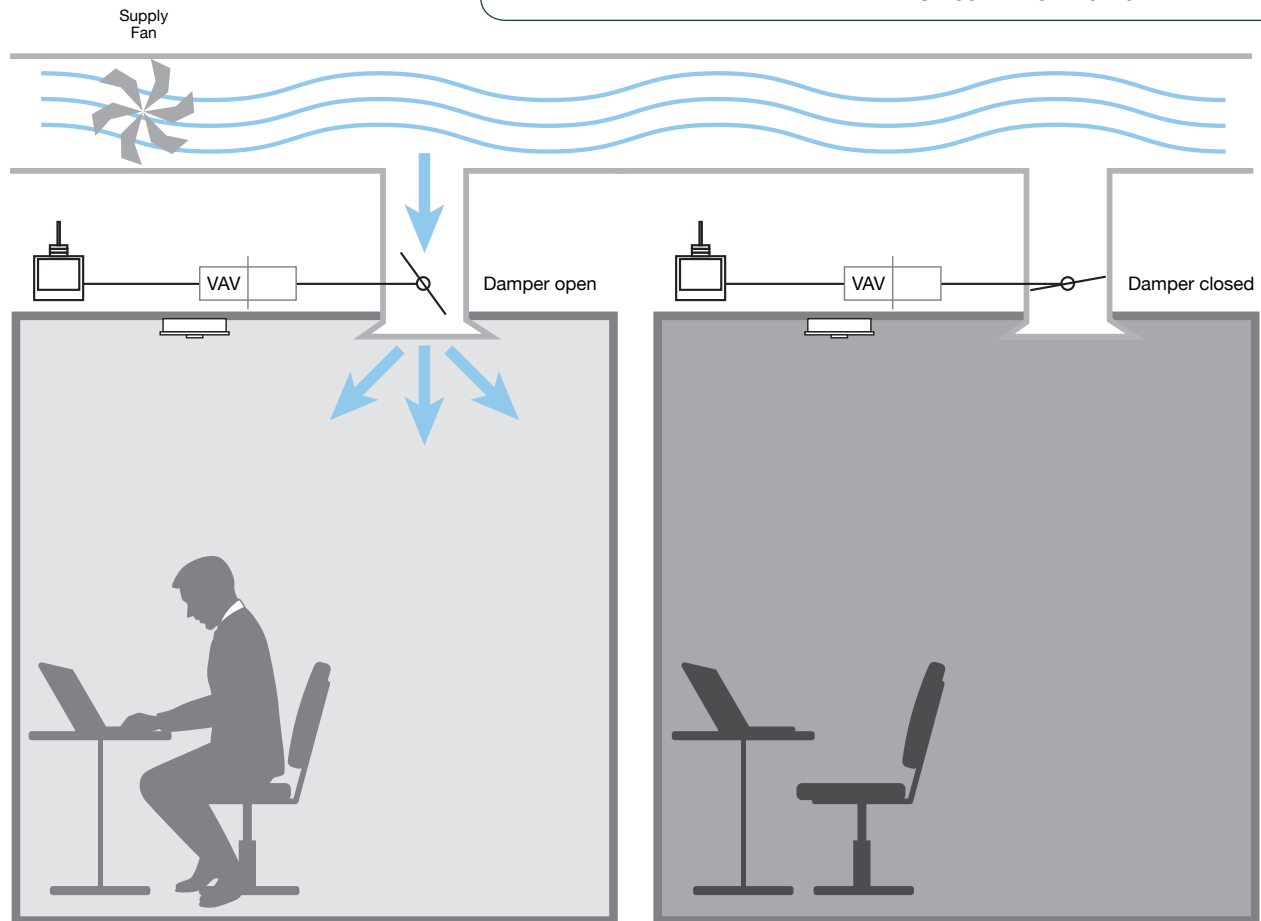

These diagrams visually represent occupancy sensor design recommendations based on specific spaces in different building types.

Stairwell Design Guide



WL Series wireless sensors are the ideal solution for stairwell applications. When unoccupied, light level is at 50%. At the moment of occupancy, fixtures associated with a sensor in a specific location will turn lights ON to full bright light level, allowing for maximum safety to the occupant.

Stairwell | Wireless Approach



WLP Series



WLC316R

Stairwell Standard Fixture

- Occupancy/Vacancy Wall Mount Sensor: **WLP Series**

Wireless Control Unit:
WLC316R

To achieve maximum safety and enhance security, a sensor can be associated to lamp fixtures a floor above and a floor below of the space where the occupant is located.

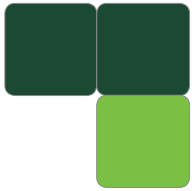

Unoccupied: 50% Light Level

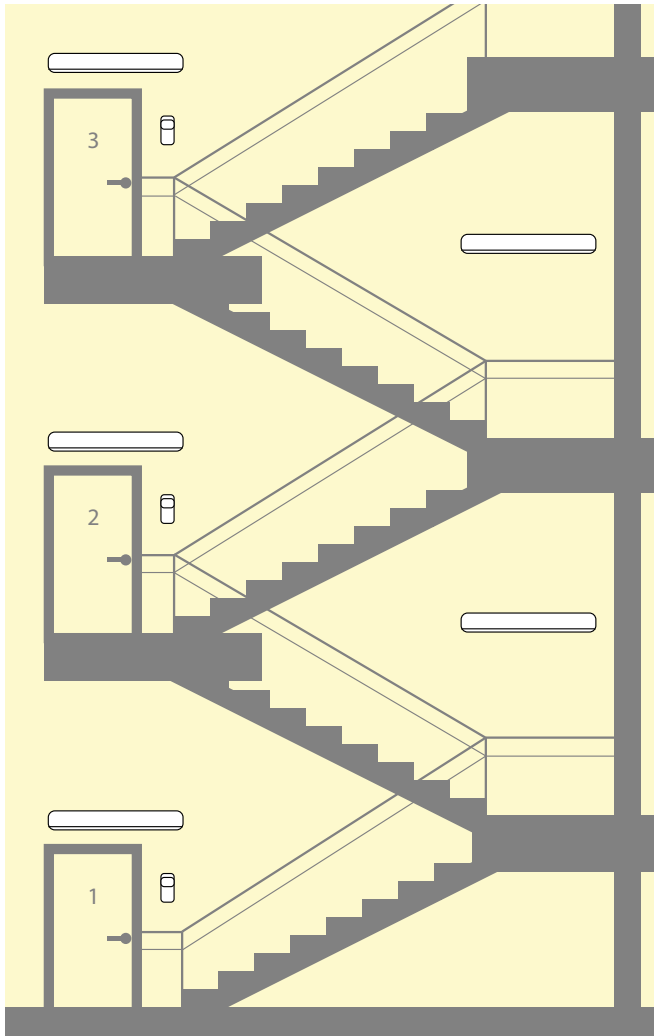

Occupied: 100% Light Level

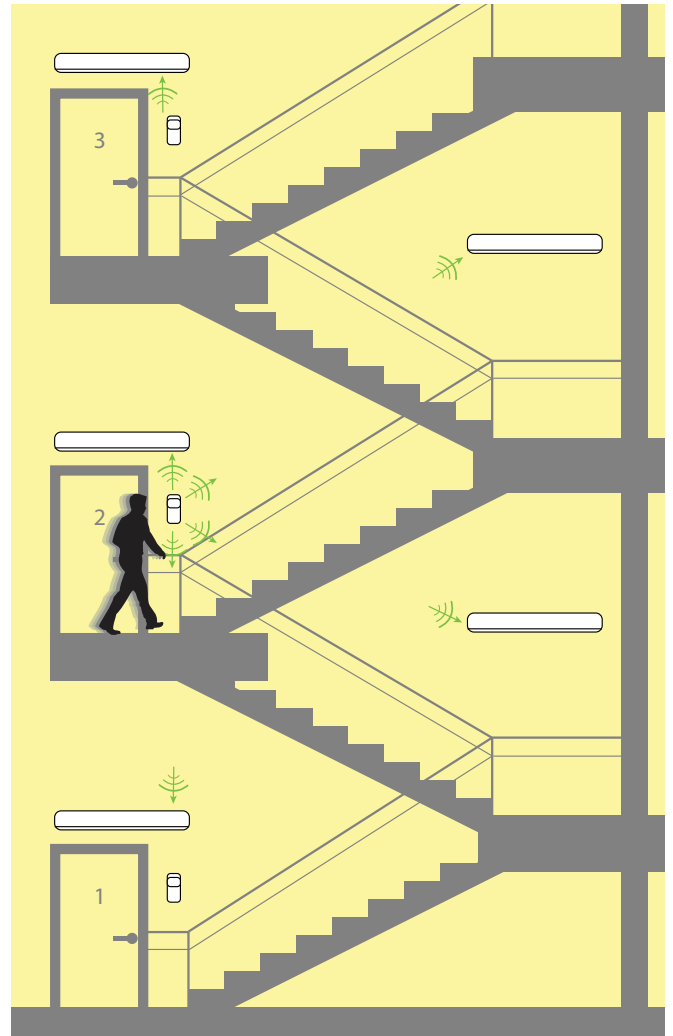

These diagrams visually represent occupancy sensor design recommendations based on specific spaces in different building types.

Ordering Information



Adaptive Wall Switch Sensors

Description	Selectable Auto ON or Manual ON Operating Modes		Vacancy Manual ON Operating Mode	
	Single Relay	Dual Relay	Single Relay	Dual Relay
Dual Technology (Ultrasonic and Passive Infrared)	AD2000xx1	AD2000xx2	AD2001xx1	AD2001xx2
Ultrasonic	AU2000xx1	AU2000xx2	AU2001xx1	AU2001xx2
Passive Infrared	AP2000xx1	AP2000xx2	AP2001xx1	AP2001xx2

Note: **xx** = Color: **BK** (Black), **GY** (Gray), **I** (Ivory), **LA** (Light Almond) and **W** (White).

Neutral Versions available on selected models. Substitute prefix "AD", "AU", "AP" for "ADN", "AUN" or "APN" prefix respectively. Consult your Hubbell Territory Manager for details.

Passive Infrared Manual Adjust Switch Sensors

Description	Selectable Auto ON or Manual ON Operating Modes		120V AC Auto ON Operating Mode		Vacancy, 120V AC Manual ON Operating Mode	
	Standard	Nightlight	Standard	Nightlight	Standard	Nightlight
No neutral required	WS2000xx	WS2000Nxx	WS1000xx	WS1000Nxx	WS1001xx	WS1001Nxx
With neutral	WS2004xx	WS2004Nxx	—	—	—	—
Dual circuit, no neutral required	—	—	WS1020xx	WS1020Nxx	WS1021xx	WS1021Nxx
Dual circuit with neutral	—	—	WS1024xx	WS1024Nxx	WS1025xx	WS1025Nxx

Note: **xx** = Color: **GY** (Gray), **I** (Ivory), **LA** (Light Almond) and **W** (White).

Low Voltage Switches

Description	Latching, 1 Button	Momentary, 1 Button	Momentary, 2 Button	Momentary, 4 Button
Low voltage switch	DSL30xx1	DSM30xx1	DSM30xx2	—
Low voltage switch with LED pilot light	—	DSM30xx1P	DSM30xx2P	DSM30xx4P

Note: **xx** = Color: **I** (Ivory), **LA** (Light Almond) and **W** (White).

Wireless Wall Switch Receivers

Description	Color	Electronic Switch 120–277V AC; No Neutral Wire Required	Accessory Switch 120V AC	Accessory Switch 277V AC
8A lighting, 3A fan (1/10 HP motor, 120V AC Only), Specification Grade	Ivory	WLS1278I	WLAS120I	WLAS277I
	White	WLS1278W	WLAS120W	WLAS277W

Wireless Ceiling and Wall Mount Sensors

Color	Ceiling Mount 360° / 324–676 sq. ft.	Wall Mount 180° / 3000 sq. ft.	Corner Mount 90° / 2500 sq. ft.	Hallway Up to 150 Linear Feet
White	WLP450C	WLP3000W	WLP2500W	WLP150H

Wireless Control Units

Description	Single (1) Circuit	Dual (2) Circuit	
Wireless load control unit with isolated relay	16A, 120/277V AC	WLC316R	—
Wireless status transmitter	24V DC	WLCA	—
Heavy duty control unit with wireless transmitter	100–277V AC	WLCU301	—
Heavy duty load control units with wireless receiver	100–277V AC	WLC301	WLC302
Furniture feed box with heavy duty relays and wireless receiver	100–277V AC	—	WLC402W

Wireless Daylight Sensor

Description	Color	Catalog Number
Daylight sensor 0–107,000 Lux (0–10,000 foot candles)	White	WLDH

Permanently Marked Receptacles for Use with Automatic Outlet Control Systems

Description	15A, Split	20A, Fully
Duplex receptacles	BR15C1xx	BR20C2xx
Decorator receptacles	DR15C1xx	DR20C2xx

Note: **xx** = Color: **BK** (Black), **GY** (Gray), **I** (Ivory), **LA** (Light Almond) and **WHI** (White).

Ordering Information



Ceiling and Wall Mount Sensors

Description	Color	Dual Technology (Ultrasonic and Passive Infrared) 2000 sq. ft. (360°)	Ultrasonic 1000 sq. ft. (180°)	Passive Infrared 120 linear feet
Ceiling low voltage sensor	Office White	ATD2000C*	ATU1000C*	—
Wall mount low voltage sensor for aisle and high bay applications	Office White	—	—	ATP120HB*

Note: *Add **RP** suffix if a photocell and isolated relay is required for HVAC or BAS integration.
For additional devices, please see our online catalog at www.hubbell-wiring.com or consult your Hubbell Territory Manager for details.

OPTIMYZER® High Bay Sensors

Description	1 Relay with Photocell, 120-347V AC	2 Relays with Photocell, 120-347V AC	Low Voltage with Photocell, 24V DC
End mount PIR sensor, indoor	HMHB219	HMHB229	HMHB2LV9
End mount PIR watertight sensor, outdoor	HMHB21UPCW	HMHB22UPCW	HMHB2LVPCW

Watertight PIR Sensors

Description	Voltage	Catalog Number
PIR sensor with isolated relay and photocell	24V DC	AHP1600WRP
Extreme temperature PIR ceiling sensor with isolated relay and photocell	24V DC	AHP1500CRP
IP66, NEMA 4X enclosure	—	ACIPE

Load:Logic® Control Panels

Description	Catalog Number
4-Relay panel with 4 spaces, 120/208/240/277V AC	CP042RRR3
8-Relay panel with 8 spaces, 120/208/240/277V AC	CP082RRR1
16-Relay panel with 16 spaces, 120/277V AC	CP162RRR1
16-Relay panel with 16 spaces, 347-480V AC	CP163RRR1

Daylight Harvesting and Dimming

Description	Voltage	Catalog Number
Single zone continuous auto dimming control daylight tracker with dimming control	0-10V DC	DHADC
Dimming PIR selectable auto ON/auto OFF manual ON/auto OFF	0-10V DC	DHTD
Dimming PIR manual ON/auto OFF (Vacancy) only	120/277V AC	APD2000xx1
Dimming PIR manual ON/auto OFF (Vacancy) only	120/277V AC	APD2001xx1

Note: **xx** = Color: **BK** (Black), **GY** (Gray), **I** (Ivory), **LA** (Light Almond) and **W** (White).

Field Installed Relays

Description	Catalog Number
Electrically held, 20A/1P, 120/277V AC, 14k SCCR, N/O	R21HN
Latching relay, 30A/1P, 120/277/347V AC, 18k SCCR	R31LX
Electrically held, 20A/2P, 480V AC, 14k SCCR, N/O	R202HN
Electrically held, 20A/2P, 480V AC, 14k SCCR, N/C	R202HC

Control Units

Description	Catalog Number
Auto ON operation, 100-277V AC, 50/60Hz	CU300A
Manual ON operation, 100-277V AC, 50/60Hz	CU300M
Heavy duty latching relay, auto or manual ON operation, 100-277V AC, 50/60Hz	CU300HD

Interface Cards

Description	Catalog Number
8-Channel dimming controller option board	CPDM8CTRB

Add-A-Relay

Description	Catalog Number
For use with CU series control units and Hubbell ATD, ATU and ATP series ceiling and wall mount sensors	AAR
Heavy duty latching relay; for use with CU300HD in plug load applications	AAR20P

Dimming Switches (Compatible with Hubbell Wiring Device Load Control Panels)

Description	1 Button	2 Button	3 Button	4 Button
Load control panel, low voltage dimming switch	CPSP1xx	CPSP2xx	CPSP3xx	CPSP4xx

Note: **xx** = Color: **I** (Ivory), **LA** (Light Almond) and **W** (White).

Coverage Patterns

LEGEND

Minor/Major Motion

Minor/Major Motion

Ultrasonic

Passive Infrared (PIR)

Wall Switch Sensors

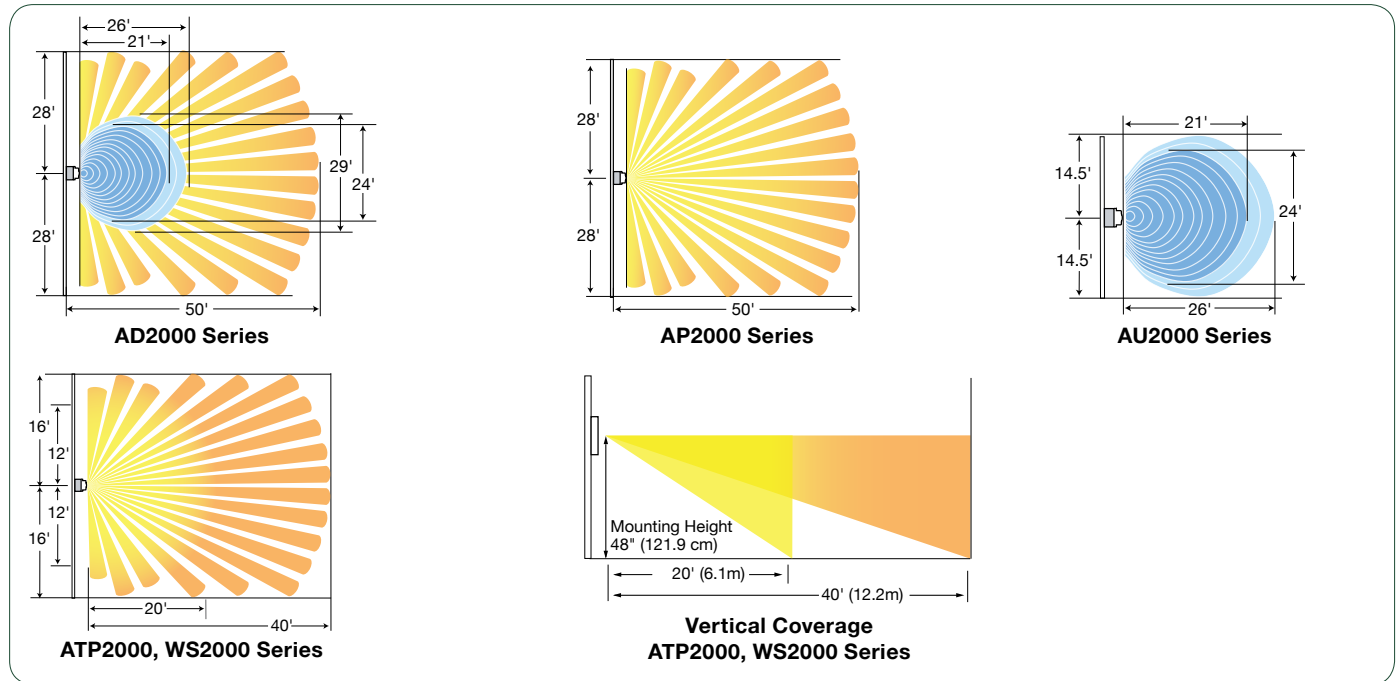

Ceiling Sensors

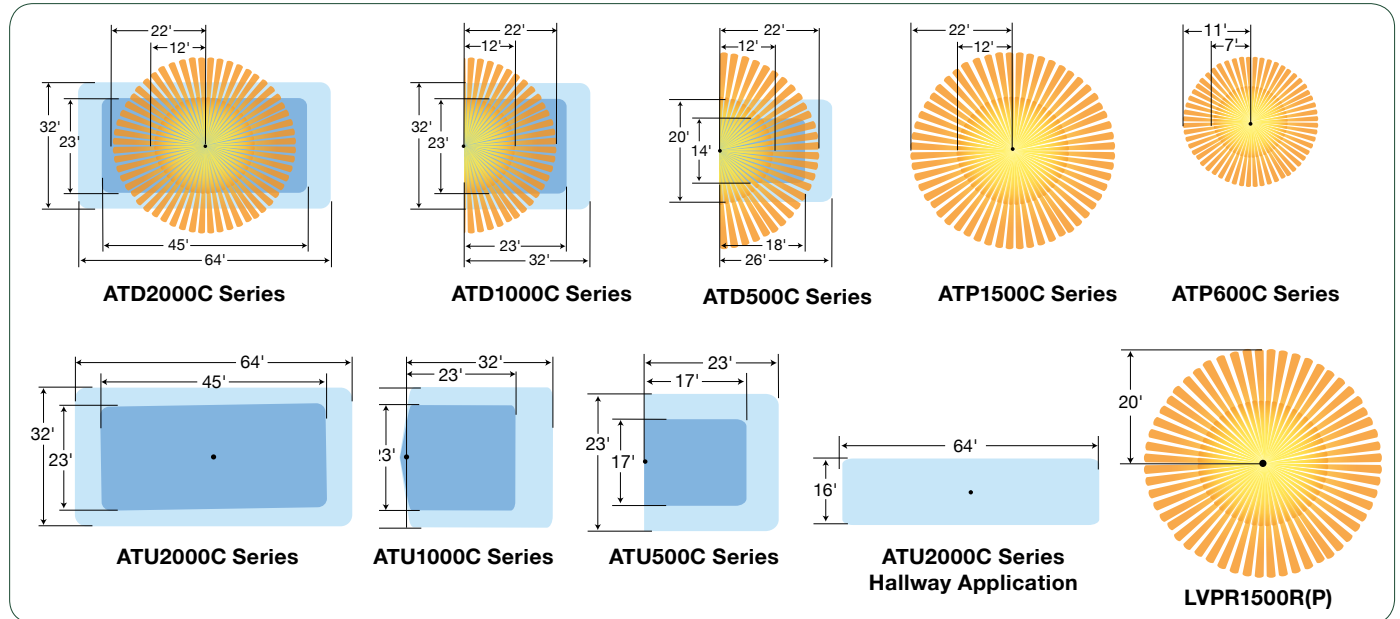

Wall Mount Sensors

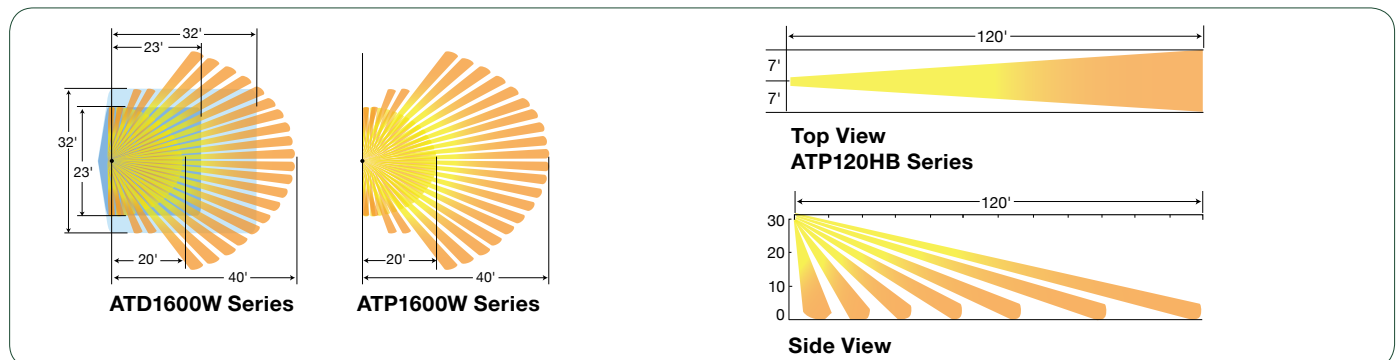

LEGEND

Minor/Major Motion

 Passive Infrared (PIR)

Wireless Sensors

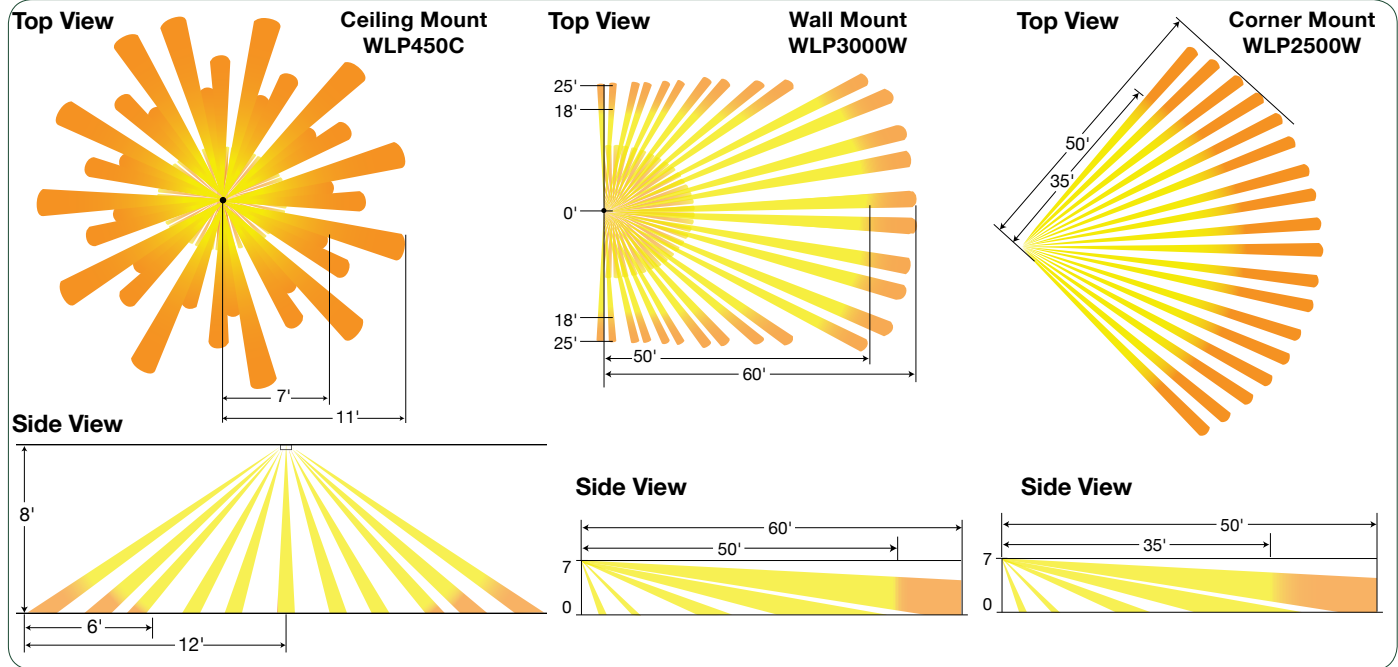

High Bay Sensors

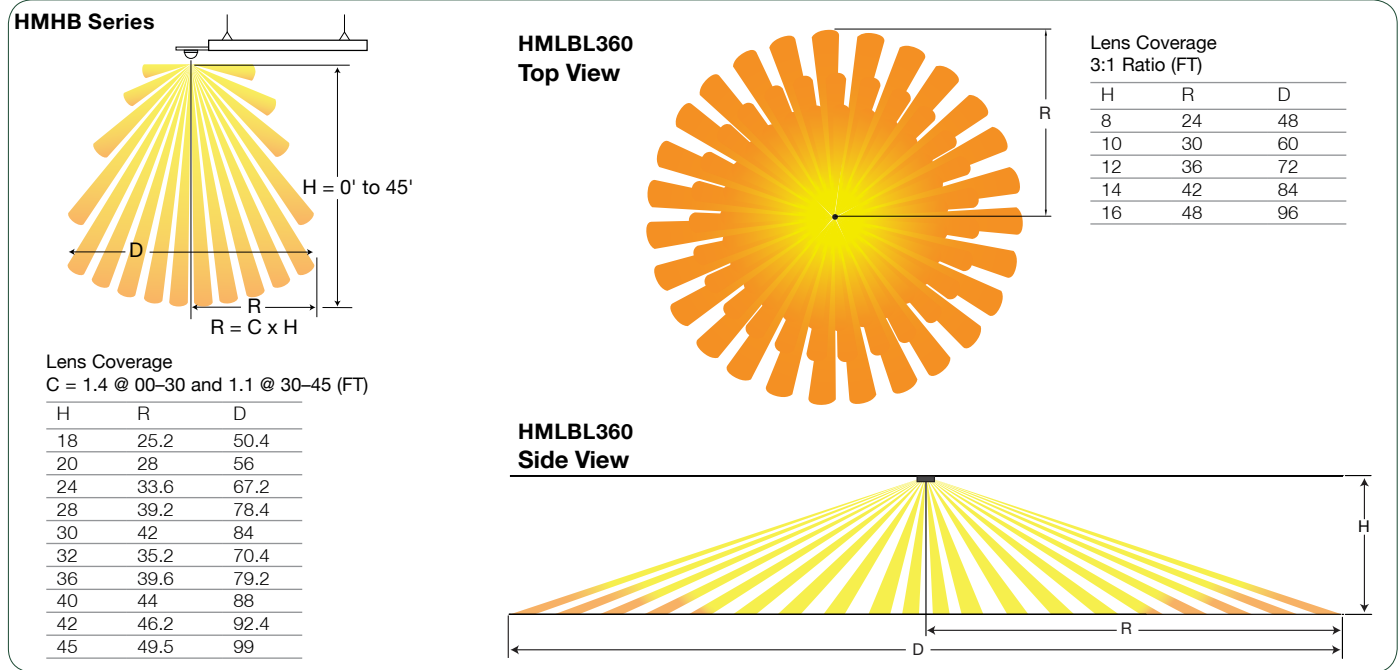

Outdoor Sensors

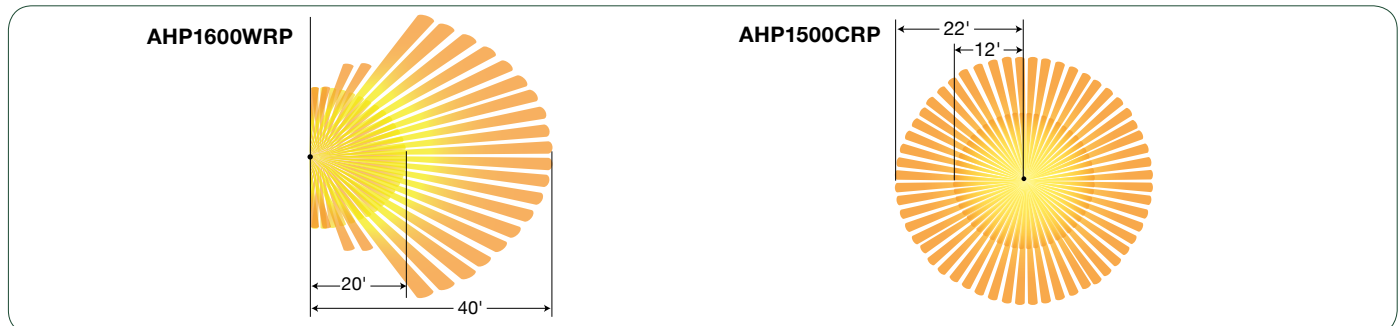

Wiring Diagrams

AD, AU, AP, 2000 Series Wall Switch Sensors

Two Relay Sensor, Wired for Two Loads

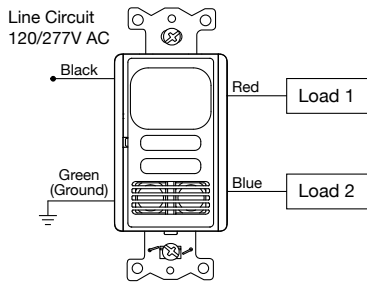

Single Circuit Sensors, Wired as 3-Way Sensors*

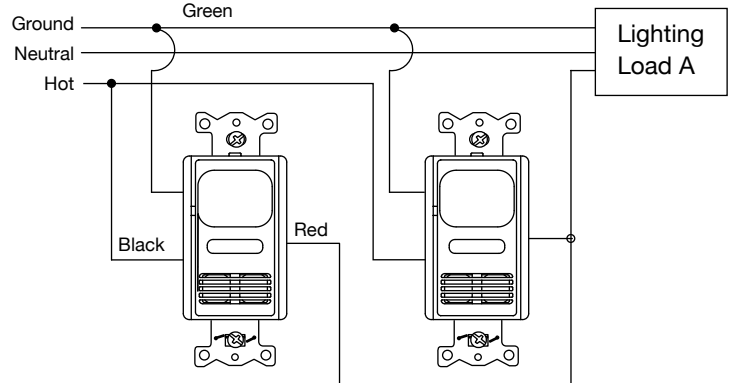

Note: *Load can not exceed the rating of one switch. Sensor is shipped with all dip switches in the OFF position (factory default).

WS2000 Series Wall Switch Sensors

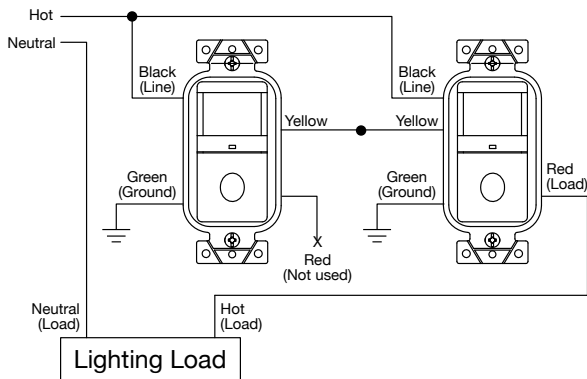

Dimming Wall Switch Sensor with Automatic Receptacle Control

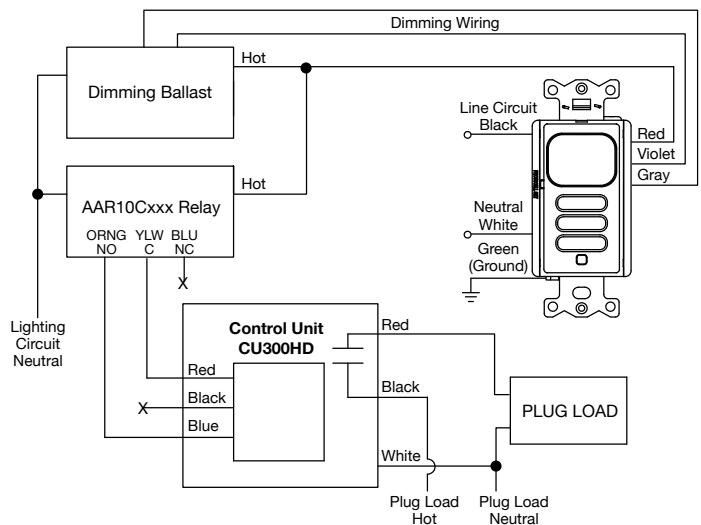

WS1020 Series Wall Switch Sensors

Dual Circuit Sensor, Wired for Dual Circuits

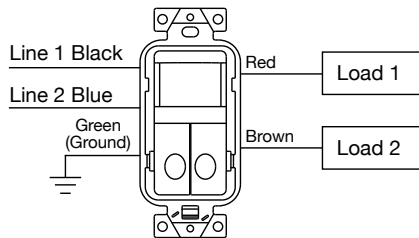

High Bay Low Voltage Sensor with Control Unit

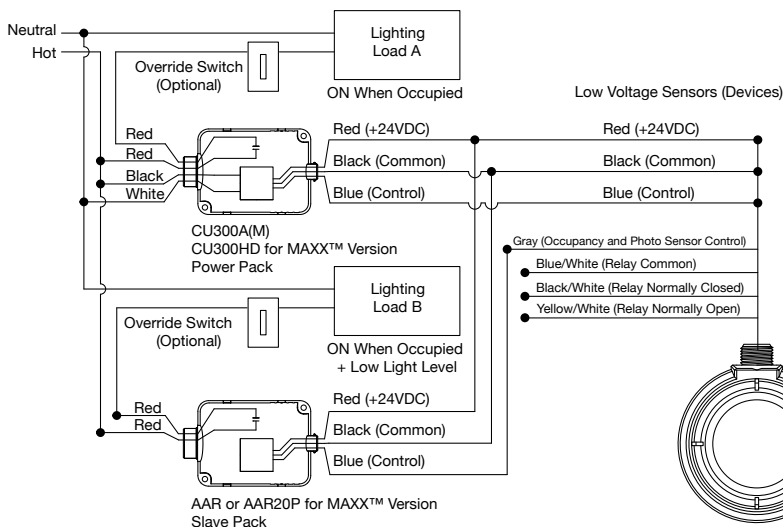

High Bay Line Voltage Sensor Dual Relay, Single Fixture

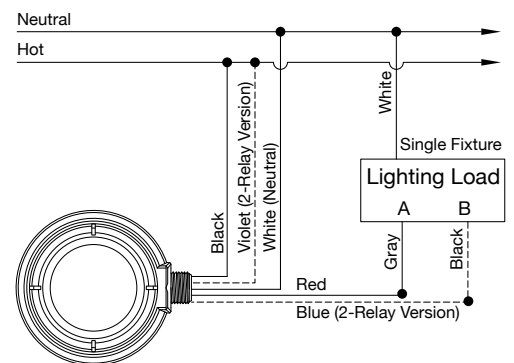

Ceiling and Wall Mount Sensors ATD, ATU and ATP Series

Single lighting circuit 1 to 4 sensors wired to control unit with optional override OFF switch application.

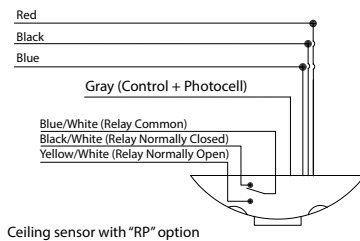
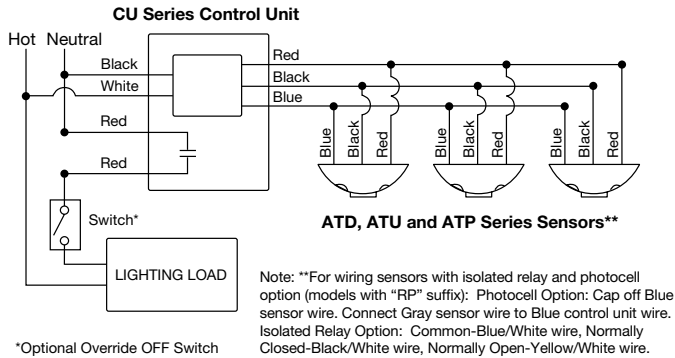

Single lighting circuit with 0-10V dimming and automatic receptacle control application.

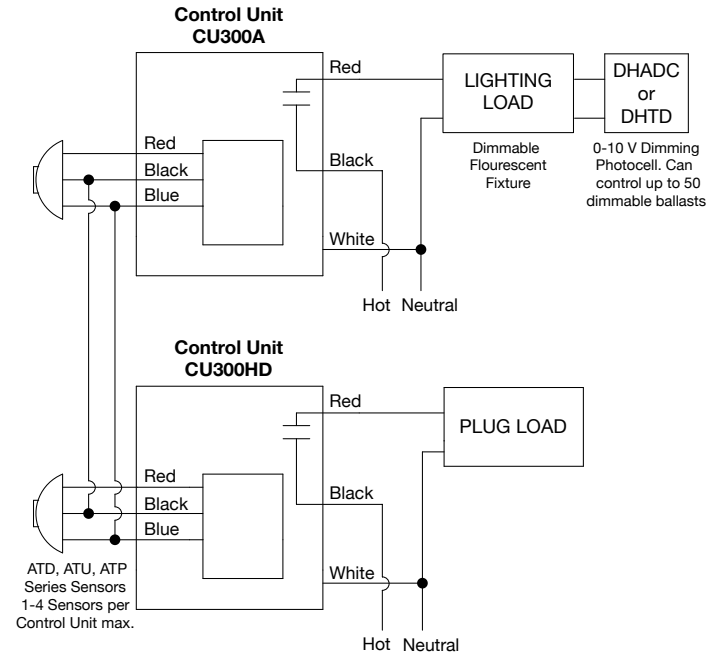

Bi-level lighting circuit and automatic receptacle control application.

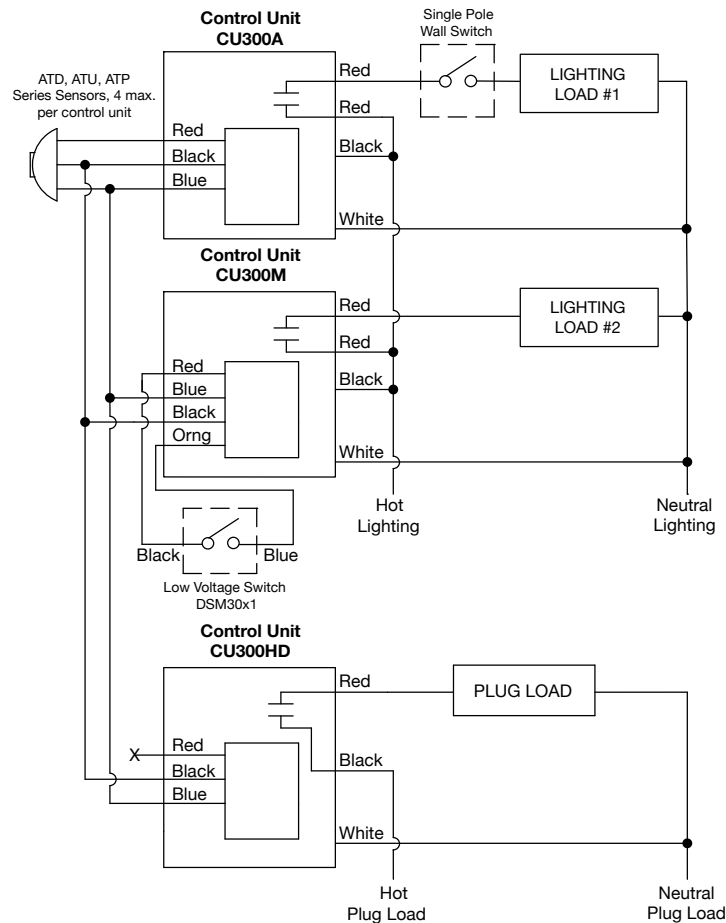

Two lighting circuits and automatic receptacle control application.

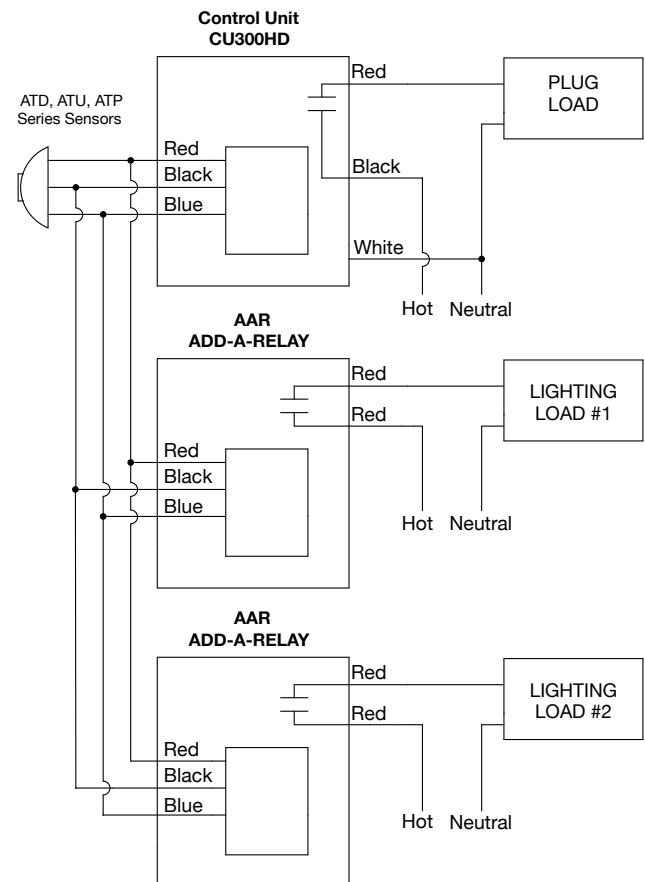

Codes and Standards Reference Table

California Energy Commission Title 24 - 2016

Code Provision	Description	Typical Control Device	Requirement	Hubbell Energy Efficiency Product Family
130.1 (a)	Area Controls	Local Switch	Readily accessible device(s) to control lighting within an enclosed space.	Wall Switch Sensors and Adaptive Ceiling Sensors with Override Switch
130.1 (c) 1 & 4	Shut-OFF Controls	Occupancy Sensors, Programmable Time clocks with Automatic Holiday feature	Occupant sensing, automatic time-switch, or other control capable of automatically shutting OFF all of the lighting when the space is unoccupied	Load:Logic® Control Panel, Wall Switch Sensors and Adaptive Ceiling Sensors
130.1 (c)5	Occupant Sensor Shut-OFF Control	Vacancy Sensor - Manual ON / Automatic Full-OFF	Automatically shuts off lighting power after vacancy of 30 minutes or less.	Vacancy Wall Switch Sensors and Adaptive Ceiling Sensors with Manual ON Feature
Light Level				
130.1 (b)	Multi-Level Lighting Controls	Step or Manual Dimming	At least one multi-level lighting control device (manual or automatic) in enclosed areas 100 sq. ft. or larger. Light level requirements are defined in Table 130.1-A.	Adaptive Dimmable Wall Switch Sensors, WL Series Sensors, OPTIMYZER® Sensors, Load:Logic® Control Panel
130.1 (c) 6 & 7	Occupant Sensor Partial-OFF Control Areas	Occupancy Sensors with dimming capability and bi-level lighting control	Automatically reduce lighting power by at least 50 percent when the areas like aisle ways, open areas in warehouses, stairwells and corridors are unoccupied.	Adaptive Wall Mount Sensors, WL Wall Sensors, OPTIMYZER® Sensors
130.1 (d) and 140.6 (d)	Automatic Daylighting Controls	Daylight Harvesting Devices	Sensor to reduce lighting in response to available daylight. Daylighting zones defined in Section 130.1(d)1. Primary daylight zones must be controlled separately from secondary zones. Refer to Table 130.1-A for lighting-level requirements.	Load:Logic® Control Panel, Adaptive Ceiling Sensors, DH-AC, DHT, WLDH I Daylighting Harvesting Sensors, WL Series Sensors, OPTIMYZER® Sensors
Additional Provisions				
130.1 (e)	Demand Responsive Controls	Receive and respond to a demand response signal for reducing lighting power	Automatically reduce lighting power by a minimum of 15% in response to a Demand Response Signal. Required for new buildings larger than 10,000 sq. ft. or luminarie alterations that increase the lighting power in the enclosed space.	Load:Logic® Control Panel
130.4	Control Acceptance and Installation Certificate Requirements	Acceptance testing (installation and functionality testing)	Code compliance, Installation requirements and Testing shall ensure that control hardware and software are calibrated, programmed, and functioning properly.	Adaptive Sensors, Wall Switch Sensors, Daylighting Harvesting Sensors, WL Series Sensors, OPTIMYZER® Sensors, Load:Logic® Family
130.5 (d)	Circuit Controls for 120-Volt Receptacles and Controlled Receptacles	Automatic controlled receptacle and Pre-marked "Controlled" receptacles	At least 50% of the 15- and 20-Amps receptacles in a shall be equipped with automatic shut-OFF control. Controlled receptacles shall have a permanent marking to differentiate them from uncontrolled receptacles.	Load:Logic® Family of Control units and Control Panel, Wall Switch Sensors and Adaptive Ceiling Sensors

Codes and Standards Reference Table

ASHRAE 90.1 - 2013

Code Provision	Description	Typical Control Device	Requirement	Hubbell Energy Efficiency Product Family
9.4.1.1 (a)	Local Control	Local Switch	Readily accessible device(s) to control lighting within an enclosed space.	Wall Switch Sensors and Adaptive Ceiling Sensors with Override Switch
9.4.1.1 (b & c)	Manual ON or Partial ON Operation	Vacancy Sensors	Manual ON when using an occupant sensor. Less than 50% of general lighting power allowed to be automatically turned ON, and none of remaining lighting automatically turned ON.	Load:Logic® Control Panel, Vacancy Wall Switch Sensors and Adaptive Ceiling Sensors
9.4.1.1 (g)	Automatic Partial OFF	Occupancy Sensors, Programmable Time clocks	Requires lighting power to be reduced by 50% within 20 minutes of all occupants leaving the space. This requirement is not optional in some spaces.	Load:Logic® Control Panel, Adaptive Ceiling OPTIMYZER® and WL Series Sensors
9.4.1.1 (h & i)	Automatic Full OFF and Scheduled Lighting Shutoff	Occupancy Sensors, Programmable Time clocks with Automatic Holiday feature	All lighting automatically shut off within 20 minutes of all occupants leaving the space by either scheduled time-of-day operated control, occupant sensor or a signal from another control system.	Load:Logic® Control Panel, Wall Switch Sensors and Adaptive Ceiling OPTIMYZER® and WL Series Sensors
Light Level				
9.4.1.1 (d)	Bi-level Lighting Control	Step or Manual Dimming	Provide at least one intermediate step in lighting power or continuous dimming in addition to full ON and full OFF. At least one control step between 30% and 70% (inclusive) of full lighting power in addition to all OFF.	Adaptive Dimmable Wall Switch Sensors, WL Series Sensors, OPTIMYZER® Sensors, Load:Logic® Control Panel
9.4.1.1 (e & f)	Automatic Daylighting Responsive Controls	Daylight Harvesting Devices	Photocell to reduce lighting in response to available daylight using either continuous dimming or at least one control point between 50% and 70%. Second control point between 20% and 40% of design light power or the lowest dimming level technology allows or all controlled lighting OFF.	Load:Logic® Control Panel, Adaptive Ceiling Sensors, DHAC, DHT, WLDH Daylighting Harvesting Sensors, WL Series Sensors, OPTIMYZER® Sensors
Additional Provisions				
9.4.3	Functional Testing	Acceptance testing (Installation and functionality testing)	Testing shall ensure that control hardware and software are calibrated, programmed, and adjusted properly within 90 days of occupancy.	Adaptive Sensors, Wall Switch Sensors, Daylighting Harvesting Sensors, WL Series Sensors, OPTIMYZER® Sensors, Load:Logic® Family
8.4.2	Automatic Receptacle Control	Automatic controlled receptacle and Pre-marked "Controlled" receptacles	In certain areas, at least 50% of the 15- and 20-Amps receptacles in a shall be automatically controlled. Shall turn OFF within 20 minutes of all occupants leaving the space. Controlled receptacles shall have a permanent marking to differentiate them from uncontrolled receptacles.	Load:Logic® Family of Control units and Control Panel, Wall Switch Sensors and Adaptive Ceiling Sensors

LOAD CONTROL

HUBBELL®
Wiring Device-Kellems

Application Guide

Energy Efficiency Products



Resources | Online

Hubbell offers a landing page dedicated to energy savings. Be sure to visit the Hubbell Wiring-Device Kellems website for more information.

Also Online | Literature

Hubbell offers an extensive literature library for product support. Downloadable PDFs are available online.

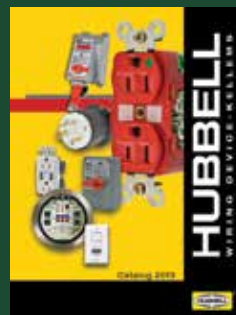

Hubbell
Wiring Device-Kellems
Catalog



Hubbell Load:Logic®
Automatic Receptacle
Control Guide



Permanently Marked
Control Receptacles
for ARCS

HUBBELL®
Wiring Device-Kellems

www.hubbell-wiring.com

